

The background of the entire page is a dark blue color, overlaid with numerous horizontal, wavy lines in various shades of blue, ranging from light to dark. These lines create a sense of movement and depth, resembling water or a stylized landscape.

DELO

SCELT I PER TE

C A T A L O G O
LISTINO N°6
2022



IL MARCHIO



Grazie alla collaborazione tra gli associati, il Gruppo Delfino ha potuto sviluppare un proprio marchio, **Delò®** che:

- è una selezione di prodotti e marche, il risultato della migliore scelta che un operatore o un utilizzatore finale può fare;
- è il frutto dello studio di un **team specializzato nel settore** che analizza le vendite, la soddisfazione degli utenti e opera quotidianamente con i più affidabili produttori italiani;
- mette a disposizione solo prodotti sottoposti ad una **lunga selezione** che tiene conto degli standard qualitativi del produttore, delle esigenze del cliente finale e dell'idraulico che deve installare il prodotto;
- offre prodotti e soluzioni per durare nel tempo proponendo il miglior prezzo per i livelli di **qualità desiderata nei diversi segmenti di offerta;**
- è una gamma che viene costantemente aggiornata e rinnovata per migliorare anche singoli dettagli tecnici ed estetici;
- si può trovare **solo (ed esclusivamente) dai rivenditori associati Delfino;**
- garantisce che tutte le sue soluzioni ottemperino alle normative vigenti in termini di certificazioni, assicurazioni di prodotto e rispetto per l'ambiente.

Il Gruppo Delfino, proprietario del brand **Delò®**, è anche **Corporate Golden Donor del FAI - Fondo Ambiente Italiano.**



UN GRUPPO ITALIANO STORICO



Il **Gruppo Delfino** è un consorzio di 49 grossisti dell'idrotermosanitario presenti con punti vendita e show-room di proprietà su gran parte del territorio italiano.

Fondato nel **1976**, rappresenta una delle prime aggregazioni di imprese che si è costituito in forma di società cooperativa senza scopo di lucro, struttura che ha permesso a Delfino di impegnarsi in progetti con impatto sociale.

Il Gruppo oggi è una rete nazionale che mette in condivisione esperienze, prodotti, soluzioni e conoscenze tecniche per dare ai propri grossisti associati un valore unico e distintivo da offrire ai loro clienti siano essi professionisti o privati.

ELENCO ASSOCIATE AL GRUPPO DELFINO ANNO 2021

REGIONE	SOCIETÀ	INDIRIZZO - CITTÀ	Telefono - E-mail
PIEMONTE	CITAB Soc Coop	Via Cavour, 114 13894 Gaglianico (BI)	Tel. 015.58.21.001 - 015.58.21.329 info@citab.it - www.citab.it
	Filiale: FORNITURE TERMOIDRAULICHE Srl	Via Quintino Sella, 19 13854 Quaregna Cerreto (BI)	Tel. 015.33.55.445 - info@fornituretermoidrauliche.eu www.fornituretermoidrauliche.eu
	CI ESSE Srl	Via Novara, 274 28021 Borgomanero (NO)	Tel. 0322.81.614 info@ciesse.biz - www.ciesse.biz
	IDROS Srl	Corso Valsesia, 45 - Bornate 13037 Serravalle Sesia (VC)	Tel. 0163.45.00.42 - info@idros.eu amministrazione@idros.eu - www.idros.eu
	BORGOTERMICA Sas	Via Cuneo, 52/E 12011 Borgo San Dalmazzo (CN)	Tel. 0171.26.62.21 borgotermica15@gmail.com - www.borgotermica.it
	Filiale "BORGOSTUFE"	Corso Barale, 103 12011 Borgo San Dalmazzo (CN)	Tel. 0171.26.39.01 borgostufe@gmail.com - www.borgostufe.it
	TERMOSANITAR EPOREDIESE Srl	Via A. Casale, 130/132 10010 Lessolo (TO)	Tel. 0125.58.296 info@termosanitar.it - www.termosanitar.it
	COMMERCIALE TERMOSANITARIA Srl	Via Marconi, 26/30 10043 Orbassano (TO)	Tel. 011.90.03.140 info@commercialetermosanitaria.com www.commercialetermosanitaria.com
	Filiale	Corso Torino, 142 10056 Oulx (TO)	Tel. 0122.83.07.06
Filiale	Via Torino, 181/A 10076 Nole Canavese (TO)	Tel. 011.92.95.312	
LOMBARDIA	COIMA Srl	Via Varese, 19 21046 Malnate (VA)	Tel. 0332.42.85.84 coima@coimasrl.it - www.coimasrl.it
	FER.COL Srl	Via Varese, 5 21052 Busto Arsizio (VA)	Tel. 0331.67.94.13 - 0331.67.82.11 danilo@fercolsrl.it
	IDROMARKET LAVENO Srl	Via Arioli, 15 21014 Laveno Mombello (VA)	Tel. 0332.66.65.87 - info@idromarket-laveno.it www.idromarket-laveno.it
	Show Room	Via Arioli, 1 21014 Laveno Mombello (VA)	Tel. 0332.66.65.87 expo@idromarket-laveno.it
	IL PIACERE Srl	Via Tre Corsi, snc 21046 Malnate (VA)	Tel. 0332.42.68.02 - info@ilpiacere.net www.ilpiacere.net
	Show Room	Viale Kennedy, 45 21046 Malnate (VA)	Tel. 0332.42.68.02
	Filiale il PIACERE.ch	Via Michele Roggia, 2 CP 19 6853 Mendrisio-Ligornetto (TI) - CH	Tel. 0041.91.646.07.36 info@ilpiacere.ch - www.ilpiacere.ch
	EREDI PIANTONI Srl	Via Sottoprovinciale, 1/4 24021 Albino (BG)	Tel. 035.77.34.05 info@pianтони.it - www.pianтони.it
	R.I.S.A.B. Srl	Via Sacco e Vanzetti, 2 20081 Abbiategrasso (MI)	Tel. 02.94.96.22.77 info@risab.it - www.risab.it
	Filiale	Corso Milano, 52 27029 Vigevano (PV)	Tel. 0381.64.58.59 info.vigevano@risab.it
	VIRES Srl	Via Messina, 99 20831 Seregno (MB)	Tel. 0362.32.66.72 vendite@viressrl.it - www.viressrl.it
	MONTAGNA Srl	Via Amendola, 98 27058 Voghera (PV)	Tel. 0383.36.66.50 info@montagnaweb.com - www.montagnaweb.com
LA SANITARIA PAVESE Srl	Via P. Bianchi, 57 27049 Stradella (PV)	Tel. 0385.49.917 - 0385.42.501 lasanitariapavese@gmail.com	
TRENTINO ALTO ADIGE	IDROFORNITURE Srl	Via Campo sportivo, 28 38023 Cles (TN)	Tel. 0463.62.52.62 info@idroforniture.it - www.idroforniture.it
	Deposito	Viale De Gasperi, 112/23 38023 Cles (TN)	Tel. 0463.62.52.62
	Deposito	Via Alto Adige, 138 38121 Trento (TN)	Tel. 0436.62.52.62
VENETO	FLUIDOINDUSTRIALE Srl	Via Bradolini, 36 31020 San Fior (TV)	Tel. 0438.40.00.82 - 0438.40.91.96 commerciale@fluidoindustriale.it
	STEMA Srl	Via Castellana, 28 35010 Trebaseleghe (PD)	Tel. 049.93.85.238 info@stema-gasparini.it - www.stema-gasparini.it
	TOMASELLA RINALDO GROUP Srl	Via Manin, 187 31015 Conegliano (TV)	Tel. 0438.45.05.73 acquisti@tomasellagroup.it - www.tomasellagroup.it
	Show Room	Viale Italia, 109 31015 Conegliano (TV)	Tel. 0438.62.817 v.italia@tomasellagroup.it
	IDRO-COMM Srl	Via E. Fermi, 15 36066 Sandrigo (VI)	Tel. 0444.65.87.58 info@idrocomm.net - www.idrocomm.net
	Filiale	Via Volta, 15 31020 Villorba (TV)	Tel. 0422.77.79.15 filialetreviso@idrocomm.net
	TECNOTERMO Srl	Via Gioberti, 26 A/B 30038 Spinea (VE)	Tel. 041.54.12.155 info@tecnotermo.biz - www.tecnotermo.biz
	Show Room		Tel. 041.54.12.155 arredobagno@tecnotermo.biz
ACQUAPROGETTI Srl	Viale del Lavoro, 5 45100 Rovigo (RO)	Tel. 0425.19.01.991 info@acquaprogetti.it - www.acquaprogetti.it	
TFR CLIMA PLUS Srl	Via Ecce Homo, 12 37054 Nogara (VR)	Tel. 0442.51.05.41 info@tfrclima.it - www.tfrclima.it	

REGIONE	SOCIETÀ	INDIRIZZO - CITTÀ	Telefono - E-mail
FRIULI VENEZIA GIULIA	LORENZO OTTOGALLI Sas	Via Crosere, 126 33053 Latisana (UD)	Tel. 0431.52.06.61 info@ottogalli.com - www.ottogalli.com
	Filiale	Via Adriano Olivetti, 40/42 33059 Fiumello Villa Vicentina (UD)	Tel. 0431.96.554 filiale@ottogalli.com
	EDILNORDUE - TERMCO Srl	Via Moimacco, 1 33043 Cividale Del Friuli (UD)	Tel. 0432.73.32.73 info@edilnorduetermco.it - www.edilnorduetermco.it
LIGURIA	S.I.R.E.A. Srl di Repetto A. & C. Show Room	Via Bontà, 95 16043 Chiavari (GE) Corso Garibaldi, 13 16043 Chiavari (GE)	Tel. 0185.31.02.31 alessandro@sireasrl.com - www.sireasrl.com Tel. 0185.02.21.86 info.expo@sireasrl.com
	PATTONO Srl	Via Filippo Casoni, 46/R 16143 Genova (GE)	Tel. 010.51.17.41 info@pattono.com - www.pattono.com
	ANDREETTO Srl	Via Benessea, 15 17035 Cisano Sul Neva (SV)	Tel. 0182.59.50.14 info@andreetto.com
	MEZZO POLLICE Srl Deposito	Via Diano Calderina snc 18013 Diano Marina (IM) Via Dell'Isola, snc 18013 Diano Castello (IM)	Tel. 0183.40.32.65 mezzopollice2007@libero.it - www.mezzopollice.it Tel. 0183.40.32.65 mezzopollice2007@libero.it
	Show Room	Via C. Colombo, 72 18013 Diano Marina (IM)	Tel. 0183.40.32.65 mezzopolliceexpo@libero.it
	CORBELLINI FERRAMENTA E IDRAULICA Srl Show Room	Via Benedetta, 155/A 43122 Parma (PR)	Tel. 0521.77.99.11 info@corbellini.it - www.corbellini.it Tel. 0521.77.99.14 - 0521.77.99.17 mostrabagno@corbellini.it
EMILIA ROMAGNA	IDROMARKET Srl Show Room	Via Statale Sud, 58 41037 Mirandola (MO)	Tel. 0535.61.04.90 info@idromarket.com Tel. 0535.61.05.02
	FATIS Srl	Via Ariosto, 10 41012 Carpi (MO)	Tel. 059.68.20.20 info@fatiscarpi.it - www.fatiscarpi.it
	PANTERMO Sas di Guiati Barbara, Roberto & C.	Via Cento, 74.C 40017 San Giovanni in Persiceto (BO)	Tel. 051.82.30.02 pantermo@libero.it - www.pantermo.it
	I.SA.F Linea Bagno Srl	Via Balzella, 71/B 47122 Forlì (FC)	Tel. 0543.72.03.91 - 0543.72.45.65 isaf@isaflineabagno.it
	ARTURO MANCINI Srl Filiale Show Room	Via Nazario Sauro, 18 47841 Cattolica (RN)	Tel. 0541.96.10.05 succ.cattolica@arturomancini.it Tel. 0541.83.49.62 - 0541.83.49.65 mostra.ca@arturomancini.it
	ARTURO MANCINI Srl Show Room	Via Gagarin, 23 61122 Pesaro (PU)	Tel. 0721.42.11 - 0721.42.12.01 info@arturomancini.it - www.arturomancini.it Tel. 0721.42.12.13 - 0721.42.12.46 mostra.ps@arturomancini.it
MARCHE	Filiale Show Room	Via Della Pineta, 21/A 61032 Fano (PU) Via Montegrappa, 5 61032 Fano (PU)	Tel. 0721.82.47.64 - 0721.82.73.55 succ.fano@arturomancini.it Tel. 0721.82.06.34 - 0721.89.71.97 arredobagno.fano@arturomancini.it
	BONCI Srl	Via A. Merlon, snc i - Z.I. Taccoli 62027 San Severino Marche (MC)	Tel. 0733.64.50.50 info@fratellibonci.it - www.fratellibonci.it
	AQUA.COM Spa Filiale	Via G. Gozzano, 157/161 51100 Sant'Agostino (PT) Via S. Donato, 31 50127 Firenze (FI)	Tel. 0573.53.20.32 info@aquacom.it - www.aquacom.it Tel. 055.07.34.246 luigi.spinelli@aquacom.it
TOSCANA	VALLATI Srl Show Room	Via Cellane, 9B 58033 Castel del Piano (GR)	Tel. 0564.95.56.90 - 0564.95.74.37 termoidraulica@vallati.com - www.vallati.com Tel. 0564.95.76.99 salamostra@vallati.com
	Show Room	Via San Michele, 578/584 53025 Piancastagnaio (SI)	Tel. 0577.78.66.84 salamostra@vallati.com
	THERMOIGIENICA Srl	Via G. D'Annunzio, 215 Loc. Querceta - 55047 Seravezza (LU)	Tel. 0584.76.81.52 thermoigienicasrl@gmail.com - www.thermoigienica.it
UMBRIA	E.T.I. Emporio Termo Idraulico Srl	Via Molise, snc - Z.I. Po' Bandino 06062 Città della Pieve (PG)	Tel. 0578.21.02.8 info@emporioeti.it - www.emporioeti.it
	ESSECCI Srl Filiale	Via L. Da Vinci, 6 06068 Tavernelle di Panicale (PG) Viale Umbria, 27/B 06063 Magione (PG)	Tel. 075.83.27.28 - 075.83.27.15 info@essecci.net - www.essecci.net Tel. 075.84.72.432 magione@essecci.net
	EDILCERAMICA EUGUBINA Srl	Via della Piaggiola, 184 06024 Gubbio (PG)	Tel. 075.92.72.611 info@edilceramicaeugubina.it - www.edilceramicaeugubina.it
	MARIANI ELIO Srl Show Room	Strada di Sabbione, 105 - Zona C14 05100 Terni (TR)	Tel. 0744.80.09.10 info@marianielio.com - www.marianielio.com Tel. 0744.81.30.18 m.serena@marianielio.com

ELENCO ASSOCIATE AL GRUPPO DELFINO ANNO 2021

REGIONE	SOCIETÀ	INDIRIZZO - CITTÀ	Telefono - E-mail
ABRUZZO	EURO COFIR Srl	Via Val Di Foro, 97 66010 Villamagna (CH)	Tel. 0871.30.10.16 eurocofir@virgilio.it
	DI MONTE Srl	Via Masciangelo, 35 66034 Lanciano (CH)	Tel. 0872.42.54.5 dimontesrl@libero.it
	Show Room "DI MONTE DESIGN"		Tel. 0872.42.54.5 info@dimontedesign.it - www.@dimontedesign.it
LAZIO	TERMOIDRAULICA COMMERCIALE CAIVIT Srl	Via Duilio Mainella, 10/12 01100 Viterbo (VT)	Tel. 0761.25.11.44 info@tccspa.it - www.caivit.it
	Show room "TCC Ti Crea Casa"		Tel. 0761.27.06.60 info@tccviterbo.it - www.tccviterbo.it
	TERMOSABINA Srl	Via G. Matteotti, 156 - Passo Corese 02032 Fara in Sabina (RI)	Tel. 0765.48.71.14 info@termosabina.it - www.termosabina.it
	ALFANI CERAMICHE Srl	Via Aurelia Km. 44,300 00052 Cerveteri (RM)	Tel. 06.99.03.303 - 308 admin@alfaniceramiche.it - www.alfaniceramiche.it
	Filiale	Via Dei Lecci, 137 00062 Bracciano (RM)	Tel. 06.99.81.54.95 termo@alfaniceramiche.it
	Filiale	Viale Guido Baccelli, 127/129/133 00053 Civitavecchia (RM)	Tel. 0766.73.22.25 civitavecchia@alfaniceramiche.it
PUGLIA	CLARK Srl	Zona Industriale 73052 - Parabita (LE)	Tel. 0833.59.30.59 info@clark srl.it - www.clark srl.it

I FORNITORI PARTNERS DELO'

GLOBO



Conex | Bänninger



NOBILIS[®]
The Best Technology for Water



RUBINETTERIA CROMATA	RUBINETTERIA CROMATA		18	
	FILTRAZIONE ACQUA POTABILE		45	
	RUBINETTERIA DA CUCINA		48	
	RUBINETTERIA LEVA CLINICA		55	
	RICAMBI RUBINETTERIA		56	
LINEA DOCCIA	TERMOSTATICI	72	SET DOCCIA	105
	COLONNE DOCCIA	78	PRESE ACQUA	106
	SALISCENDI	90	IDROSCOPINI E KIT DOCCETTA	109
	SOFFIONI DOCCIA	95	FLESSIBILI DOCCIA	112
	BRACCI DOCCIA	100	RICAMBI	113
	DOCCETTE	102		
SANITARI	VETROCHINA E FIRE CLAY		116	
	AUSILI BAGNO DISABILI		125	
	SEDILI		137	
	CASSETTE DI SCARICO		140	
	LAVATOI		148	
COMPLEMENTI SANITARI	SIFONAME		154	
	RUBINETTERIA SOTTOLAVABO, LAVATRICE E VARIA		174	
	FLESSIBILI ACQUA E ANTIVIBRANTI		181	
	SISTEMI DI FISSAGGIO		184	
	TRITURATORI E POMPE SOLLEVAMENTO		185	
PRODOTTI TECNICI	MINUTERIA IDRAULICA E ACCESSORI		190	
	PRODOTTI TECNICI E CHIMICI		196	
	CONTATORI ACQUA		203	
	RUBINETTERIA DA ESTERNO		205	
	RUBINETTI GALLEGGIANTI		207	
ACCESSORI CONDIZIONAMENTO	STAFFE PER CONDIZIONATORI		212	
	SCARICO CONDENSA		212	
	ACCESSORI CONDIZIONAMENTO		214	
	RACCORDERIA A PRESSARE IN RAME			
	PER ARIA CONDIZIONATA E REFRIGERAZIONE		216	
RISCALDAMENTO	SCALDABAGNI	220	CIRCOLATORI	241
	TERMOARREDO ELETTRICO	222	ACCESSORI SOTTOCALDAIA	242
	TERMOARREDO	224	RIDUTTORI DI PRESSIONE	247
	RADIATORI IN ALLUMINIO	228	MANOMETRI E TERMOMETRI	248
	ACCESSORI RADIATORI	237		
IMPIANTISTICA	MULTISTRATO	252	GIUNTI ESTENSIBILI ED ANTIVIBRANTI	
	RACCORDERIA IN OTTONE	260	GAS E ACQUA	297
	RACCORDERIA IN RAME-BRONZO	277	TUBO SOLARE	302
	RACCORDERIA PER TUBO POLIETILENE	291	ISOLAMENTO IN GOMMA	304
			ISOLAMENTO IN POLIETILENE	306



INDICE ANALITICO - CATALOGO LISTINO N° 6 - 2022

	Descrizione prodotto	pag.		Descrizione prodotto	pag.
A	accessori e curve tecniche per wc	118-195		collettori per impianti sanitari	257
	accessori e ricambi sifoname	171		colonna vasca	164
	accessori per cassette di scarico	142		colonne doccia	86
	accessori per condizionamento	212		colonne doccia multifunzione	78
	accessori per idroscopini e kit doccia	111		CONDIBAT spray	201-215
	accessori per isolamento in gomma	306		condizionamento: accessori	212
	accessori per lavatrice	179		conex compression	271
	accessori per radiatori	237		conex o-ring	273
	accessori per scaldabagni elettrici	221		contatori acqua	203
	accessori per termoarredo	227		copriforo per lavabo - bidet	193
	accessori per termometri e manometri	249		coprilavatrice	148
	accessori per tubo solare	303		CS CLEANER disincrostante per cassette WC	201
	accessori radiatori	237		cursori per saliscendi	113
	adesivo per pvc - TANGIT	198		curve in poliuretano espanso	309
	aeratori	67		curve tecniche wc e accessori	118-195
	alzawater	132		curvette sottolavabo	176
	antialghe per impianti a pavimento	196	D	defangatori	245-246
	antigelo per impianti solari	196		detergente liquido per giunti elettrosaldabili	201
	antivibranti	183-214		detergente schiumogeno per condizionatori	201-215
	ausili per disabili	125		detergente spray per giunti elettrosaldabili	201
B	basi pavimento per unità esterne	214		detergenti per impianti di riscaldamento	196
	BASICFLOW	160		deviatori incasso per doccia	77
	batterie per cassette	143		devolgitore per twin solar slim	303
	benda vinilica	200		disabili: maniglioni	130
	biconi cromati	191-261		disabili: sanitari	125
	biconi ottone tenuta metallica (conex compression)	271		disincrostante cassette	201
	biconi ottone tenuta o-ring	273	disincrostante per scambiatori	196	
	bocche di erogazione	65	disotturante liquido	202	
	boiler elettrici	220	doccette	102	
	bomboletta per ritocchi (RAL 9010)	239	dosatori polifosfati	244	
C	bracci doccia	100	DRIP STOP mastice bicomponente	198	
	canapa	198	E	ERMETIC pasta verde	197
	canotti per cassetta	144		EXTRA GAS pasta marrone	197
	canotti per sifoni	169	F	fascette stringitubo per tubo alluminio	301
	cartellatrice per tubi flessibili	300		fascia perimetrale	308
	cartucce per miscelatori	56		FERNOX	196
	cartuccia ricambio kit DELO' PUR	46-63		filter fluid+protector	196-246
	cassetta alta in porcellana	120		filtrazione acqua potabile	45
	cassette di scarico - accessori	142		filtro raccogli impurità	275
	cassette di scarico - ricambi GROHE	146		filtro valvola ritegno	275
cassette di scarico ad incasso	141	fissaggi e supporti per sanitari e scaldabagno		184	
cassette di scarico esterne	140	flange in acciaio zincato		296	
chiave per aeratori	69	flessibili acqua		181	
chiave per tappi radiatori	238	flessibili antivibranti	183		
circulatori acqua calda sanitaria	241	flessibili doccia	112		
circulatori per caldaia	241	flessibili gas per cucina	297		
CLIMAFOAM spray	201-215	flessibili per caldaia	297		
colla per isolamento in gomma	198-306	flessibili per contatore	299		

INDICE ANALITICO - CATALOGO LISTINO N° 6 - 2022

Descrizione prodotto	pag.
flessibili per gas	297
flessibili per lavatrice	179
fluido termovettore per impianti solari	196
foglia in pvc	309
FONOMETAL	306
G galleggianti	207
galleggianti per cassette di scarico	143-207
giunti antivibranti	298
giunti di transizione	294
giunti dielettrici	294
glicole per termoarredo	227
GROHE BLUE HOME STARTER KIT	45
GROHE SMARTBOX	44-74
GROHE: BAUEDGE lavello	50
GROHE: cassette	141
GROHE: corpi incasso	44-74
GROHE: doccette	103
GROHE: filtro BWT per GROHE BLUE	47-63
GROHE: GROHE BLUE PURE EUROSMART STARTER KIT	46
GROHE: ricambi per cassetta	146
GROHE: ricambi per rubinetteria	58
GROHE: rubinetteria elettronica	43
GROHE: saliscendi	92
GROHE: serie EUROSMART	36
GROHE: serie EUROSTYLE	34
GROHE: termostatici	75
guaina isolante in rotoli (FONOMETAL)	306
guarnizioni per radiatori	239
I idroscopini	109
ISOFOM R	308
isolamento in gomma	304
isolamento in gomma per solare	303
isolamento in polietilene	307
ISOPIU'	309
K kit antivibranti per condizionatori	214
kit DELO' PUR	46
kit doccetta	109
kit flessibili per caldaia	299
kit tappi per radiatori	237
kit tubo corrugato gas per uso domestico	297-300
KOLMAT pasta	197
L lastra isolante in rotoli	305
lavabi d'arredo	119
lavabo ad angolo in porcellana	119
lavatoi in resina con mobile	148
lavatrice: accessori	179
LOCTITE	197
lubrificante multiuso WD 40	202

Descrizione prodotto	pag.
M manicotti per wc	194
maniglioni per disabili INOX	131
maniglioni per disabili verniciati	130
manometri	248
mensole per condizionatori	212
mensole per radiatori	240
MINIFLOW	161
minuteria idraulica	190
miscelatore lavello cucina 3 acque GIULIO	46-48
mobiletto sottoceramica	150
mobili lavanderia	148
morsetti per wc e curve tecniche	194
multistrato	252
N NANOFLOW	160
nastri adesivi	200
nastri P.T.F.E. (teflon)	199
nastro alluminio	200
nastro anticondensa	199-215-306
nastro dielettrico	200
nastro segnaletico ACQUA	200
nastro segnaletico GAS	200
neutralizzatori di condensa	243
NEUTRASLIM	243
O orinatoio sospeso in ceramica	120
P pasta KOLMAT	197
pasta marrone	197
pasta verde	197
piatti doccia in porcellana	121
piatti doccia per disabili	127
piedini antivibranti	214
pilette lavabo e bidet	69-165
pilette lavello	167
pilette sifonate e set piatti doccia	160
pilozzi in polipropilene	151
pilozzi in porcellana	120
POLAR	307
polifosfati in capsule, polvere e liquido	244
pompa scarico condensa per caldaia	242
pompe di sollevamento e tritatori	185
pompe dosatrici polifosfato	244
pompe scarico condensa per condizionatori	213
porcellana per bagno	116
portagomma in ottone	270
portasapone per saliscendi	113
prese a staffa in polipropilene (pp)	293
prese d'acqua	106
prodotti chimici	196
protettivo per impianti di riscaldamento	196

INDICE ANALITICO - CATALOGO LISTINO N° 6 - 2022

Descrizione prodotto	pag.	Descrizione prodotto	pag.
R raccorderia elettrosaldabile	295	rubinetteria cromata: serie EUROSMART	36
raccorderia in bronzo a brasare	281	rubinetteria cromata: serie EUROSTYLE	34
raccorderia in bronzo a pressare per acqua	285	rubinetteria cromata: serie EVA	39
raccorderia in bronzo a pressare per gas	288	rubinetteria cromata: serie MAYA	25
raccorderia in ottone con o-ring	273	rubinetteria cromata: serie NEMO	30
raccorderia in ottone conex compression	271	rubinetteria cromata: serie TONDA	21
raccorderia in ottone cromata filettatura cilindrica	260	rubinetteria cromata: serie TRADIZIONALE	41
raccorderia in ottone cromata filettatura conica	262	rubinetteria cromata: serie ZERO	28
raccorderia in ottone giallo filettatura cilindrica	269	rubinetteria da cucina	48
raccorderia in ottone giallo filettatura conica	264	rubinetteria da esterno	205
raccorderia in rame a brasare	277	rubinetteria elettronica	43
raccorderia in rame a pressare per acqua	283	rubinetteria leva clinica	55
raccorderia in rame a pressare per condizionamento	216-289	rubinetteria per colonne doccia	76
raccorderia in rame a pressare per gas	287	rubinetteria termostatica	72
raccorderia per multistrato per acqua	255	rubinetti antighiaccio	205
raccorderia per multistrato per gas	252	rubinetti galleggianti	207
raccorderia per tubo flessibile cartellabile	300	rubinetti galleggianti per cassette di scarico	143
raccorderia per tubo impianti solari	303	rubinetti per cassetta wc	143-177
raccorderia per tubo polietilene	291	rubinetti per idrante	205
raccordi a compressione per multistrato acqua	258	rubinetti per lavatrice	178
raccordi per contatore	203	rubinetti sottolavabo a sfera	174
raccordi per scaldabagno	177-221	rubinetti sottolavabo a vitone	175
raccordi per tubo ferro	276	S saliscendi	90
raccordo 5 vie	276	SANICOMPACT	186
radiatori alluminio: accessori	237	SANICONDENS	242
radiatori alluminio: modello KLASS	234	SANICUBIC 1	187
radiatori alluminio: modello MIX	230	sanificante per condizionatori	201-215
radiatori alluminio: modello OSCAR	235	SANINEUTRAL	243
radiatori alluminio: modello OSCAR TONDO	236	SANIPACK PRO	186
radiatori alluminio: modello SEBINO	228	SANIPLUS	185
radiatori alluminio: modello VIP	233	SANISLIM	185
radiatori alluminio: modello VOX	231	sanitari per disabili	125
radiatori alluminio: modello VOX EXTRA	232	sanitari per disabili: accessori	128
ricambi e accessori sifoname	171	sanitari per disabili: alzawater	132
ricambi linea doccia	113	sanitari per disabili: maniglioni	130
ricambi per scaldabagni elettrici	221	sanitari per disabili: piatti doccia	127
ricambi rubinetteria cromata	56	sanitari per disabili: seggiolini e sgabelli	133
ricariche neutralizzatori di condensa	244	sanitari per disabili: serie CASUAL	125
ricariche polifosfati in capsule, polvere e liquido	244	sanitari per disabili: vasche	136
riduttori di pressione	247	sanitari: piatti doccia	121
rigenerante per impianti di riscaldamento	196	sanitari: serie GRACE	116
rilevatore fughe gas	202	SANITOP	185
rosette per radiatori	240	SANITRIT	185
rosoni	192	saracinesche	275
rubinetteria cromata: deviatori incasso per doccia	77	sbobinatrice per TWIN SOLAR SLIM	303
rubinetteria cromata: ricambi	56	scaldabagni elettrici	220
rubinetteria cromata: serie DADO	18	schiuma poliuretana	198
rubinetteria cromata: serie DELFINO DUE	32	scivolina	201

INDICE ANALITICO - CATALOGO LISTINO N° 6 - 2022

Descrizione prodotto	pag.
sedili anticontatto	132
sedili sgancio rapido	139
sedili universali e adattabili	137
sedili: alzwater per disabili	132
sedili: per serie ausili disabili	126
seggiolini per disabili	133
serpentine per manometri	249
set doccia	106
set doccia pavimento	160
sfere per rubinetti galleggianti	209
sgabelli per doccia	134
SGORGOSI' - SGORGOSI' GEL	202
sifoni a vista in ottone	154
sifoni abs cromati	157
sifoni in ottone	155
sifoni in polipropilene (pp) lavabo e bidet	158
sifoni lavatrice	179
sifoni lavello	159
sifoni pavimento	160
sifoni per piatti doccia	163
sifoni scarico condensa	213
sifoni tubolari in ottone	156
sifoni vasca	164
sigillaperdite bicomponente	198
sigillaperdite per impianti di riscaldamento	196
siliconi e sigillanti	197
soffioni doccia economici	99
soffioni doccia in abs	98
soffioni doccia in ottone	95
soffioni doccia inox	96
solvacal disincrostante in polvere	201
spandiacqua per turca	144
spray per giunti elettrosaldabili	201
staffe per condizionatori	212
staffe per sanitari sospesi	142-184
stazione di sollevamento	187
striscie butiliche	198
SUMISURA	160
supporti doccia	108
supporti e fissaggi per sanitari e scaldabagno	184
supporto regolabile per pilozzo	184
T TANGIT	198
TANGIT detergente	201
tanica glicole per termoarredo	227
tappi copriforo	193
tappi e riduzioni per radiatori	237
tappi per piletta	172
tappi prova impianto	193

Descrizione prodotto	pag.
teflon in nastri	199
telo protettivo per unità esterne	215
termoarredo elettrico: modello CLOE	222
termoarredo: accessori	227
termoarredo: modello GIADA	225
termoarredo: modello GIULIA	224
termomanometri	248
termometri	249
termometri e manometri: accessori	249
termostatici esterni	75
termostatici incasso	72
termostatici per colonne doccia	76
tracciante vernice spray	202
trattamento e manutenzione impianti	196
triturator	185
tubi cromati in ottone e rame	190
tubo alluminio bianco	301
tubo alluminio naturale	301
tubo carico e scarico lavatrice	179
tubo cartellabile per acqua e gas	300
tubo corrugato gas uso domestico	297
tubo estensibile per lavabi e lavelli	171
tubo estensibile per WC	195
tubo gas per uso domestico	297
tubo multistrato acqua	254
tubo multistrato gas	252
tubo per impianti solari	302
tubo poliuretano espanso (ISOPIU')	309
tubo scarico per cassette wc	144
TUBOFIX	276
turca in porcellana	120
TWIN SOLAR SLIM	302
V valvola esterna lavatrice	180
valvole clapet	276
valvole di fondo	275
valvole di ritegno	275
valvole sfogo aria	239
vasche per disabili	136
vetrochina e fire clay	116
vitoni per rubinetteria e termostatici	59
W WD 40 lubrificante multifunzione	202
WOLTMANN contatori	204

CATALOGO
LISTINO N° 6

RUBINETTERIA CROMATA

RUBINETTERIA CROMATA	18
FILTRAZIONE ACQUA POTABILE	45
RUBINETTERIA DA CUCINA	48
RUBINETTERIA LEVA CLINICA	55
RICAMBI RUBINETTERIA	56

RUBINETTERIA CROMATA

Serie DADO

POSSIBILI FINITURE



Nero opaco



Bianco opaco



Simil acciaio

LAVABO



Scarico automatico 1"1/4 spessore regolabile, con meccanismo clicker.

RICAMBI (PAG. 56-69)

3101102 - Maniglia cromo

3101097 - Cartuccia D. 25

	codice	finitura	UM	min. ord.	conf.	cat.	prezzo (€)
●	3001010	cromo	NR	1	5	11	
●	3001910	nero opaco	NR	1	1	11	
	3001710	bianco opaco	NR	1	1	11	
	3001810	simil acciaio	NR	1	1	11	

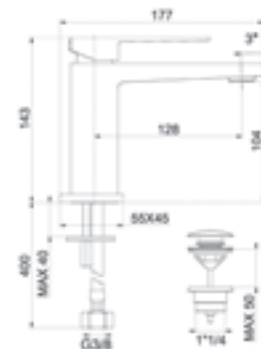

LAVABO ALTO



Scarico automatico 1"1/4 spessore regolabile, con meccanismo clicker.

RICAMBI (PAG. 56-69)

3101102 - Maniglia cromo

3101097 - Cartuccia D. 25

	codice	finitura	UM	min. ord.	conf.	cat.	prezzo (€)
●	3001011	cromo	NR	1	5	11	
●	3001911	nero opaco	NR	1	1	11	
	3001711	bianco opaco	NR	1	1	11	
	3001811	simil acciaio	NR	1	1	11	

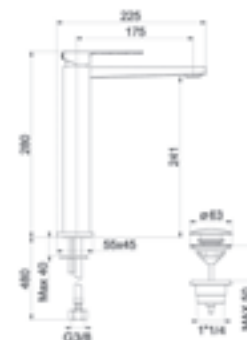

LAVABO A PARETE 2 PEZZI

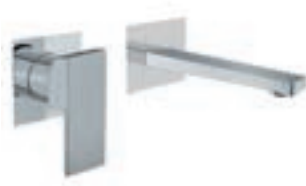

Bocca di erogazione lunghezza totale 190 mm., senza scarico.

RICAMBI (PAG. 56-69)

3101103 - Maniglia cromo

3101098 - Cartuccia D. 42

	codice	finitura	UM	min. ord.	conf.	cat.	prezzo (€)
●	3001013	cromo	NR	1	5	11	
●	3001913	nero opaco	NR	1	1	11	
	3001713	bianco opaco	NR	1	1	11	
	3001813	simil acciaio	NR	1	1	11	

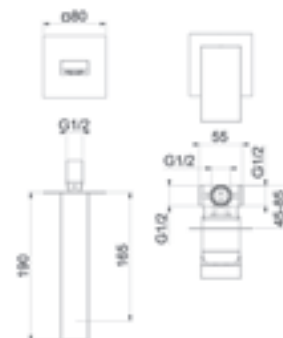

BIDET



Scarico automatico 1"1/4 spessore regolabile, con meccanismo clicker.

RICAMBI (PAG. 56-69)

3101102 - Maniglia cromo

3101097 - Cartuccia D. 25

	codice	finitura	UM	min. ord.	conf.	cat.	prezzo (€)
●	3001012	cromo	NR	1	5	11	
●	3001912	nero opaco	NR	1	1	11	
	3001712	bianco opaco	NR	1	1	11	
	3001812	simil acciaio	NR	1	1	11	

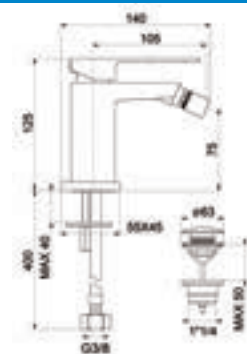

DOCCIA INCASSO CON DEVIATORE



Deviatore a pulsante. Incluso corpo incasso.

RICAMBI (PAG. 56-69)

3101103 - Maniglia cromo

3101098 - Cartuccia D. 42

3101124 - Prolunga cromo

codice	finitura	UM	min. ord.	conf.	cat.	prezzo (€)
● 3001015	cromo	NR	1	10	11	
● 3001915	nero opaco	NR	1	1	11	
3001715	bianco opaco	NR	1	1	11	
3001815	simil acciaio	NR	1	1	11	

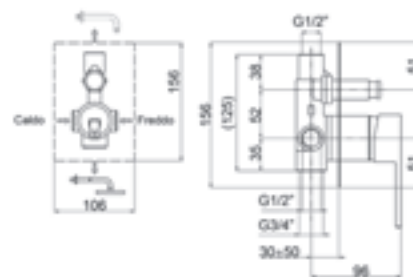

DOCCIA INCASSO



Incluso corpo incasso.

RICAMBI (PAG. 56-69)

3101103 - Maniglia cromo

3101098 - Cartuccia D. 42

3101123 - Prolunga cromo

codice	finitura	UM	min. ord.	conf.	cat.	prezzo (€)
● 3001014	cromo	NR	1	10	11	
● 3001914	nero opaco	NR	1	1	11	
3001714	bianco opaco	NR	1	1	11	
3001814	simil acciaio	NR	1	1	11	

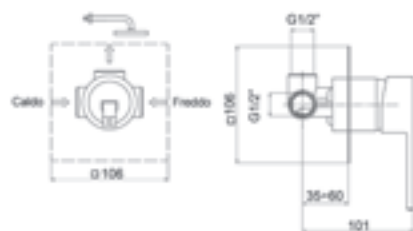

DOCCIA INCASSO CON DEVIATORE SOLO PARTI ESTERNE



Solo parti esterne cromate, da completare con il corpo incasso a due vie (3005102). Deviatore a pulsante.

RICAMBI (PAG. 56-69)

3101103 - Maniglia cromo

codice	finitura	UM	min. ord.	conf.	cat.	prezzo (€)
● 3001020	cromo	NR	1	10	11	

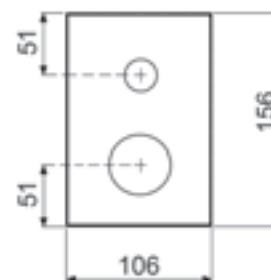

DOCCIA INCASSO SOLO PARTI ESTERNE



Solo parti esterne cromate, da completare con il corpo incasso a una via (3005101).

RICAMBI (PAG. 56-69)

3101103 - Maniglia cromo

codice	finitura	UM	min. ord.	conf.	cat.	prezzo (€)
● 3001019	cromo	NR	1	10	11	



DOCCIA INCASSO CON DEVIATORE 3 VIE



Deviatore a manopola. Compreso corpo incasso.

RICAMBI (PAG. 56-69)

3101103 - Maniglia cromo

3101098 - Cartuccia D. 42

codice	finitura	UM	min. ord.	conf.	cat.	prezzo (€)
● 3001016	cromo	NR	1	10	11	
● 3001916	nero opaco	NR	1	1	11	
3001716	bianco opaco	NR	1	1	11	
3001816	simil acciaio	NR	1	1	11	

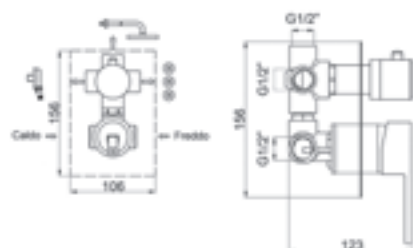

RUBINETTERIA CROMATA

Serie DADO

CORPO INCASSO 2 VIE

Con protezione.

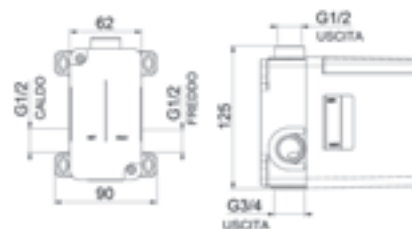

codice	finitura	UM	min. ord.	conf.	cat.	prezzo (€)
● 3005102	cromo	NR	1	1	11	

CORPO INCASSO 1 VIA

Con protezione.

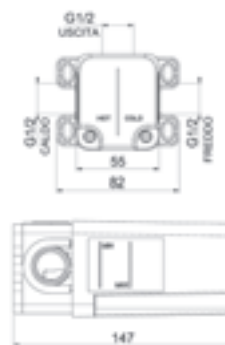

codice	finitura	UM	min. ord.	conf.	cat.	prezzo (€)
● 3005101	cromo	NR	1	1	11	

DOCCIA ESTERNO



RICAMBI (PAG. 56-69)
3101102 - Maniglia cromo
3101097 - Cartuccia D. 25

codice	finitura	UM	min. ord.	conf.	cat.	prezzo (€)
● 3001018	cromo	NR	1	5	11	
3001918	nero opaco	NR	1	1	11	
3001718	bianco opaco	NR	1	1	11	
3001818	simil acciaio	NR	1	1	11	

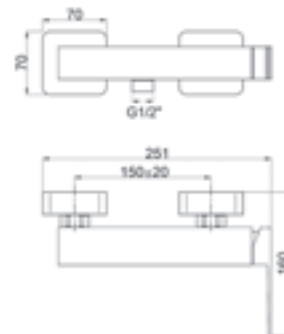

VASCA CON KIT DOCCIA



RICAMBI (PAG. 56-69)
3101102 - Maniglia cromo
3101097 - Cartuccia D. 25

codice	finitura	UM	min. ord.	conf.	cat.	prezzo (€)
● 3001017	cromo	NR	1	5	11	
3001917	nero opaco	NR	1	1	11	
3001717	bianco opaco	NR	1	1	11	
3001817	simil acciaio	NR	1	1	11	

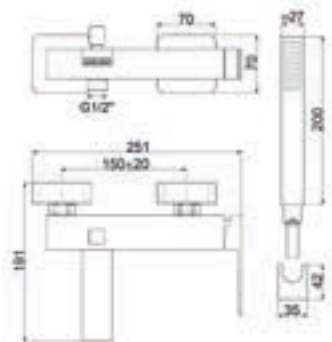

POSSIBILI FINITURE

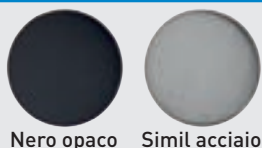

Nero opaco Simil acciaio

LAVABO

Scarico 1"1/4



RICAMBI (PAG. 56-69)
3101106 - Maniglia cromo
3101101 - Cartuccia D. 35
2751200 - Areatore cachè

codice	finitura	UM	min. ord.	conf.	cat.	prezzo (€)
● 3021010	cromo	NR	1	5	11	
● 3021910	nero opaco	NR	1	1	11	
3021810	simil acciaio	NR	1	1	11	

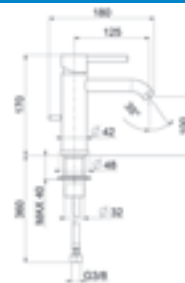

LAVABO CLICK/CLACK

Scarico automatico 1"1/4, spessore regolabile con meccanismo clicker.



RICAMBI (PAG. 56-69)
3101106 - Maniglia cromo
3101101 - Cartuccia D. 35
2751200 - Areatore cachè

codice	finitura	UM	min. ord.	conf.	cat.	prezzo (€)
● 3021026	cromo	NR	1	1	11	
● 3021926	nero opaco	NR	1	1	11	
3021826	simil acciaio	NR	1	1	11	



LAVABO ALTO

Scarico automatico 1"1/4, spessore regolabile con meccanismo clicker.



RICAMBI (PAG. 56-69)
3101106 - Maniglia cromo
3101101 - Cartuccia D. 35

codice	finitura	UM	min. ord.	conf.	cat.	prezzo (€)
● 3021011	cromo	NR	1	5	11	
● 3021911	nero opaco	NR	1	1	11	
3021811	simil acciaio	NR	1	1	11	



LAVABO A PARETE 2 PEZZI

Senza scarico.



RICAMBI (PAG. 56-69)
3101098 - Cartuccia D. 42

codice	finitura	UM	min. ord.	conf.	cat.	prezzo (€)
● 3021013	cromo	NR	1	5	11	
● 3021913	nero opaco	NR	1	1	11	
3021813	simil acciaio	NR	1	1	11	

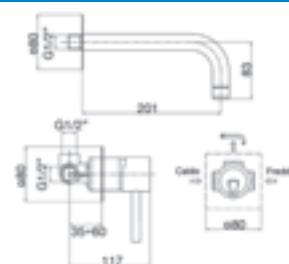

RUBINETTERIA CROMATA

Serie TONDA

LAVABO A PARETE PIASTRA UNICA

Senza scarico.



RICAMBI (PAG. 56-69)

3101106 - Maniglia cromo

3101100 - Cartuccia D. 35

	codice	finitura	UM	min. ord.	conf.	cat.	prezzo (€)
●	3021014	cromo	NR	1	5	11	
	3021914	nero opaco	NR	1	1	11	
	3021814	simil acciaio	NR	1	1	11	

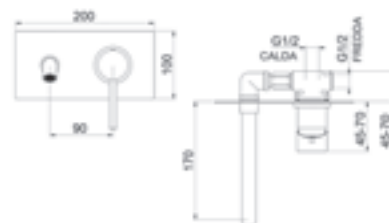

BIDET

Scarico 1"1/4



RICAMBI (PAG. 56-69)

3101106 - Maniglia cromo

3101101 - Cartuccia D. 35

2751200 - Aeratore

	codice	finitura	UM	min. ord.	conf.	cat.	prezzo (€)
●	3021012	cromo	NR	1	5	11	
●	3021912	nero opaco	NR	1	1	11	
	3021812	simil acciaio	NR	1	1	11	



BIDET CLICK/CLACK

Scarico automatico 1"1/4, spessore regolabile con meccanismo clicker.



RICAMBI (PAG. 56-69)

3101106 - Maniglia cromo

3101101 - Cartuccia D. 35

2751200 - Aeratore

	codice	finitura	UM	min. ord.	conf.	cat.	prezzo (€)
●	3021027	cromo	NR	1	1	11	
●	3021927	nero opaco	NR	1	1	11	
	3021827	simil acciaio	NR	1	1	11	



DOCCIA INCASSO CON DEVIATORE

Deviatore a pulsante. Incluso corpo incasso



RICAMBI (PAG. 56-69)

3101098 - Cartuccia D. 42

3101124 - Prolunga cromo

	codice	finitura	UM	min. ord.	conf.	cat.	prezzo (€)
●	3021016	cromo	NR	1	10	11	
●	3021916	nero opaco	NR	1	1	11	
	3021816	simil acciaio	NR	1	1	11	

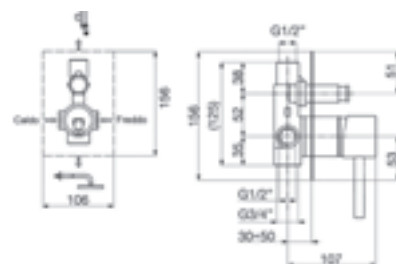

DOCCIA INCASSO

Incluso corpo incasso.



RICAMBI (PAG. 56-69)
3101098 - Cartuccia D. 42
3101123 - Prolunga cromo

codice	finitura	UM	min. ord.	conf.	cat.	prezzo (€)
● 3021015	cromo	NR	1	10	11	
● 3021915	nero opaco	NR	1	1	11	
● 3021815	simil acciaio	NR	1	1	11	

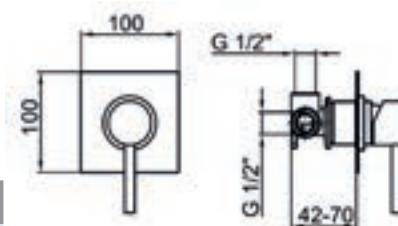

DOCCIA INCASSO CON DEVIATORE 2 VIE

Deviatore a manopola. Compreso corpo incasso.



RICAMBI (PAG. 56-69)
3101106 - Maniglia cromo
3101100 - Cartuccia D. 35

codice	finitura	UM	min. ord.	conf.	cat.	prezzo (€)
● 3021017	cromo	NR	1	10	11	
● 3021917	nero opaco	NR	1	1	11	
● 3021817	simil acciaio	NR	1	1	11	

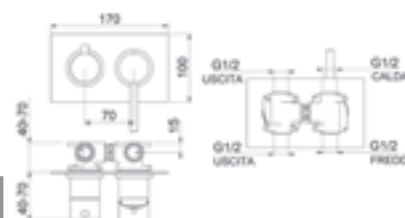

DOCCIA INCASSO CON DEVIATORE 3 VIE

Deviatore a manopola. Compreso corpo incasso.



RICAMBI (PAG. 56-69)
3101098 - Cartuccia D. 42

codice	finitura	UM	min. ord.	conf.	cat.	prezzo (€)
● 3021018	cromo	NR	1	5	11	
● 3021918	nero opaco	NR	1	1	11	
● 3021818	simil acciaio	NR	1	1	11	

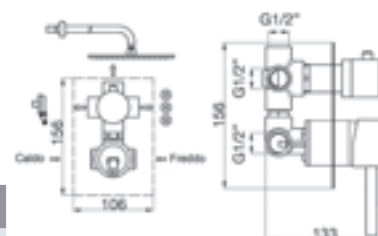

DOCCIA INCASSO CON DEVIATORE SOLO PARTI ESTERNE

Solo parti esterne cromate, da completare con il corpo incasso a due vie (3005102).

Deviatore a pulsante



codice	finitura	UM	min. ord.	conf.	cat.	prezzo (€)
● 3021022	cromo	NR	1	10	11	

Corpo incasso 2 vie con protezione.

codice	finitura	UM	min. ord.	conf.	cat.	prezzo (€)
● 3005102	cromo	NR	1	1	11	

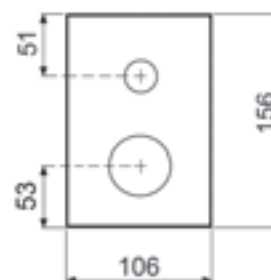

RUBINETTERIA CROMATA

Serie TONDA

DOCCIA INCASSO SOLO PARTI ESTERNE



Solo parti esterne cromate, da completare con il corpo incasso a una via (3005101)

codice	finitura	UM	min. ord.	conf.	cat.	prezzo (€)
● 3021021	cromo	NR	1	10	11	

Corpo incasso 1 via con protezione.

codice	finitura	UM	min. ord.	conf.	cat.	prezzo (€)
● 3005101	cromo	NR	1	1	11	



DOCCIA ESTERNO



RICAMBI (PAG. 56-69)
3101104 - Maniglia cromo
3101099 - Cartuccia D. 35

codice	finitura	UM	min. ord.	conf.	cat.	prezzo (€)
● 3021020	cromo	NR	1	5	11	
3021920	nero opaco	NR	1	1	11	
3021820	simil acciaio	NR	1	1	11	

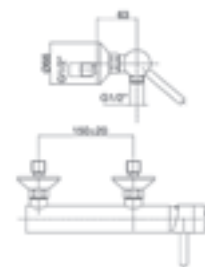

VASCA CON KIT DOCCIA



RICAMBI (PAG. 56-69)
3101100 - Cartuccia D. 35

codice	finitura	UM	min. ord.	conf.	cat.	prezzo (€)
● 3021019	cromo	NR	1	5	11	
3021919	nero opaco	NR	1	1	11	
3021819	simil acciaio	NR	1	1	11	

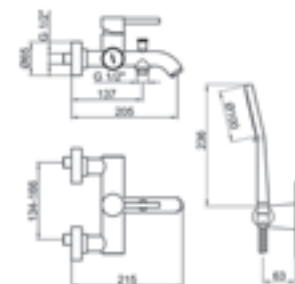

VASCA A PAVIMENTO



RICAMBI (PAG. 56-69)
3101101 - Cartuccia D. 35

codice	finitura	UM	min. ord.	conf.	cat.	prezzo (€)
● 3021031	cromo	NR	1	1	11	
3021931	nero opaco	NR	1	1	11	
3021831	simil acciaio	NR	1	1	11	

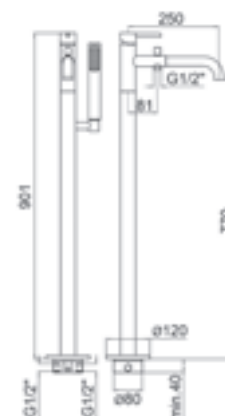

La serie MAYA dispone di una particolare tecnologia per l'ottimizzazione dell'efficienza energetica:

LIMITATORE DI ENERGIA: Apertura dell'erogazione dell'acqua fredda con leva in posizione centrale, evitando l'accensione involontaria della caldaia. Inserito sugli artt. 3008001, 3008002, 3008003, 3008010.

LIMITATORE DI TEMPERATURA: permette di decidere la temperatura massima dell'acqua.

REGOLATORE DINAMICO DI PORTATA: blocca l'alzata della leva al raggiungimento della metà della portata, riducendo il consumo del 50%.

CARTUCCIA D. 35 mm A IMMERSIONE TOTALE: diminuisce l'usura meccanica della cartuccia

LAVABO

Scarico 1"1/4



5
l/min

RICAMBI (PAG. 56-69)
3008903 - Maniglia
3008908 - Cartuccia

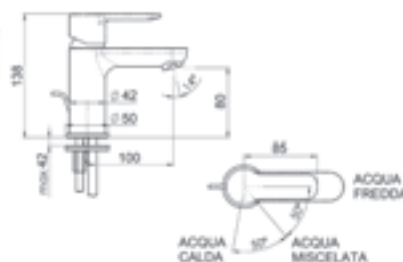

codice	UM	min. ord.	conf.	cat.	prezzo (€)
● 3008001	NR	1	10	11	

LAVABO MANIGLIA STANDARD

Scarico 1"1/4, apertura maniglia classica.



RICAMBI (PAG. 56-69)
3008913 - Maniglia
3008906 - Cartuccia

codice	UM	min. ord.	conf.	cat.	prezzo (€)
● 3008011	NR	1	10	11	

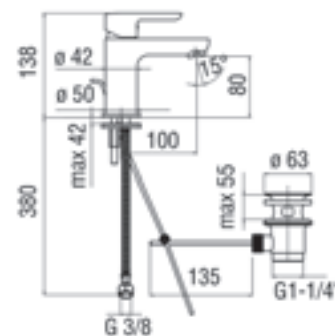

LAVABO "BIG SIZE"

Scarico 1"1/4



5
l/min

RICAMBI (PAG. 56-69)
3008903 - Maniglia
3008908 - Cartuccia

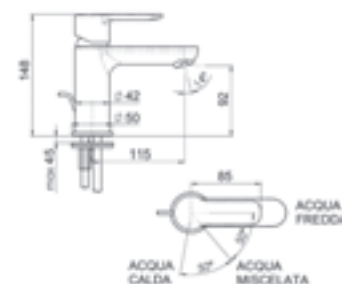

codice	UM	min. ord.	conf.	cat.	prezzo (€)
● 3008010	NR	1	10	11	

LAVABO "BIG SIZE" MANIGLIA STANDARD

Scarico 1"1/4, apertura maniglia classica.



RICAMBI (PAG. 56-69)
3008913 - Maniglia
3008906 - Cartuccia

codice	UM	min. ord.	conf.	cat.	prezzo (€)
● 3008009	NR	1	10	11	

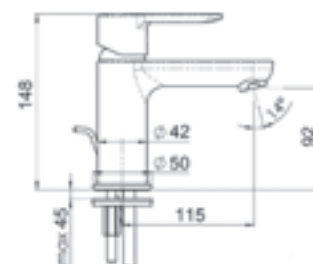

RUBINETTERIA CROMATA

Serie MAYA

LAVABO CORPO ALTO



5
l/min

Scarico automatico 1"1/4,
con meccanismo clicker.

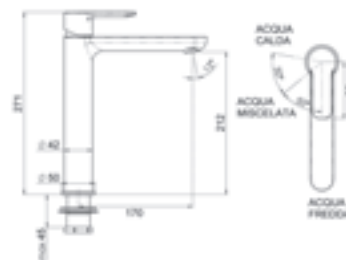

RICAMBI (PAG. 56-69)
3008903 - Maniglia
3008908 - Cartuccia

codice	UM	min. ord.	conf.	cat.	prezzo (€)
● 3008002	NR	1	6	11	

BIDET



5
l/min

Scarico 1"1/4

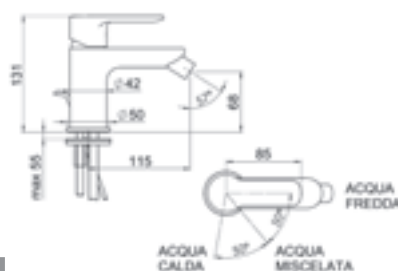

RICAMBI (PAG. 56-69)
3008903 - Maniglia
3008908 - Cartuccia
2751204 - Aeratore cachè

codice	UM	min. ord.	conf.	cat.	prezzo (€)
● 3008003	NR	1	10	11	

BIDET MANIGLIA STANDARD



Scarico 1"1/4, apertura maniglia classica.

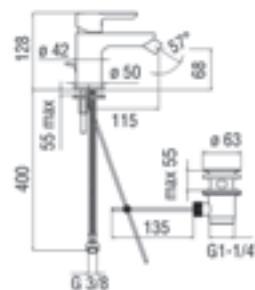

RICAMBI (PAG. 56-69)
3008913 - Maniglia
3008906 - Cartuccia
2751204 - Aeratore cachè

codice	UM	min. ord.	conf.	cat.	prezzo (€)
● 3008012	NR	1	10	11	

DOCCIA INCASSO CON DEVIATORE



Incluso corpo incasso

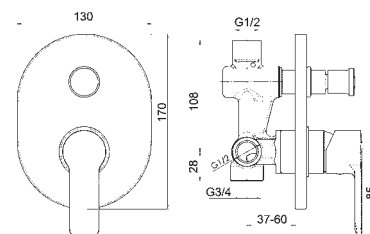

RICAMBI (PAG. 56-69)
3008913 - Maniglia
3008904 - Cartuccia
3008910 - Deviatore
3008918 - Prolunga

codice	UM	min. ord.	conf.	cat.	prezzo (€)
● 3008006	NR	1	8	11	

DOCCIA INCASSO

Incluso corpo incasso



RICAMBI (PAG. 56-69)
3008913 - Maniglia
3008904 - Cartuccia
3008919 - Prolunga

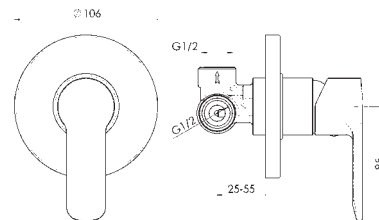

codice	UM	min. ord.	conf.	cat.	prezzo (€)
● 3008004	NR	1	30	11	

DOCCIA ESTERNO



RICAMBI (PAG. 56-69)
3008913 - Maniglia
3008904 - Cartuccia

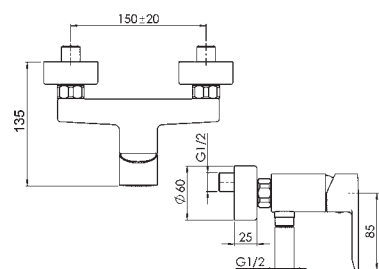

codice	UM	min. ord.	conf.	cat.	prezzo (€)
● 3008005	NR	1	20	11	

VASCA CON KIT DOCCIA

Flessibile cm. 150



RICAMBI (PAG. 56-69)
3008913 - Maniglia
3008905 - Cartuccia

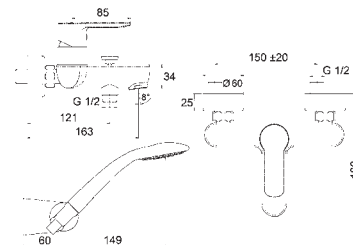

codice	UM	min. ord.	conf.	cat.	prezzo (€)
● 3008007	NR	1	8	11	

RUBINETTERIA CROMATA

Serie ZERO

La serie ZERO dispone di una particolare tecnologia per l'ottimizzazione dell'efficienza energetica:

LIMITATORE DI TEMPERATURA: permette di decidere la temperatura massima dell'acqua.

REGOLATORE DINAMICO DI PORTATA: blocca l'alzata della leva al raggiungimento della metà della portata, riducendo il consumo del 50% (Escluso 3008802)

CARTUCCIA D. 35 mm A IMMERSIONE TOTALE: diminuisce l'usura meccanica della cartuccia.

LAVABO



Aeratore a scomparsa,
Scarico 1"1/4

RICAMBI (PAG. 56-69)

3008906 - Cartuccia

2751060 - Aeratore

codice	UM	min. ord.	conf.	cat.	prezzo (€)
● 3008801	NR	1	10	03	

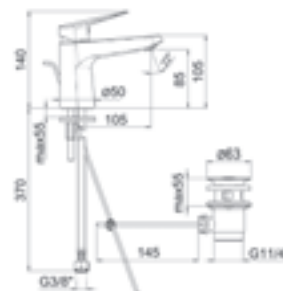

LAVABO LEVA CLINICA



Aeratore a scomparsa,
Scarico 1"1/4

RICAMBI (PAG. 56-69)

3008901 - Leva clinica

3008915 - Cartuccia

2751060 - Aeratore

codice	UM	min. ord.	conf.	cat.	prezzo (€)
● 3008802	NR	1	10	03	

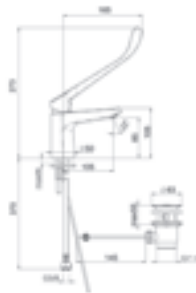

BIDET



Scarico 1"1/4

RICAMBI (PAG. 56-69)

3008906 - Cartuccia

2751204 - Aeratore cachè

codice	UM	min. ord.	conf.	cat.	prezzo (€)
● 3008803	NR	1	10	03	

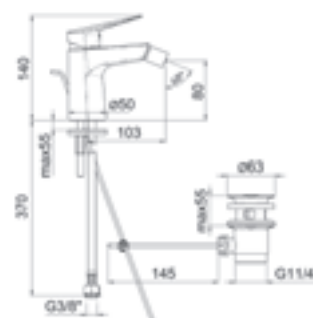

DOCCIA INCASSO CON DEVIATORE



Incluso corpo incasso

RICAMBI (PAG. 56-69)

3008904 - Cartuccia

3008918 - Prolunga

codice	UM	min. ord.	conf.	cat.	prezzo (€)
● 3008805	NR	1	8	03	

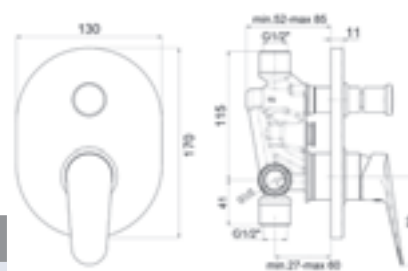

DOCCIA INCASSO

Incluso corpo incasso



RICAMBI (PAG. 56-69)
3008904 - Cartuccia
3008919 - Prolunga

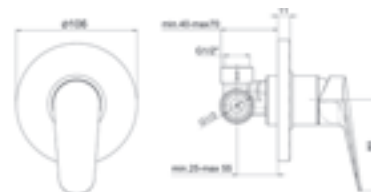

codice	UM	min. ord.	conf.	cat.	prezzo (€)
● 3008804	NR	1	30	03	

DOCCIA ESTERNO



RICAMBI (PAG. 56-69)
3008904 - Cartuccia

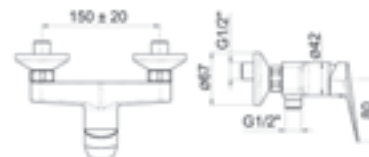

codice	UM	min. ord.	conf.	cat.	prezzo (€)
● 3008806	NR	1	20	03	

VASCA CON KIT DOCCIA



RICAMBI (PAG. 56-69)
3008906 - Cartuccia

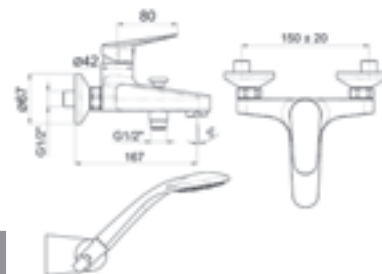

codice	UM	min. ord.	conf.	cat.	prezzo (€)
● 3008807	NR	1	8	03	

RUBINETTERIA CROMATA

Serie NEMO

La serie NEMO dispone di una cartuccia da 35 mm.

LAVABO

Scarico 1"1/4



RICAMBI (PAG. 56-69)

3101075 - Maniglia

3101074 - Cartuccia

codice	UM	min. ord.	conf.	cat.	prezzo (€)
● 3003010	NR	1	10	03	

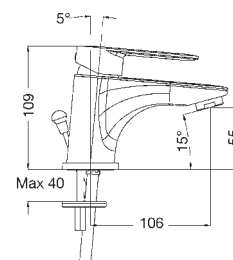

LAVABO LEVA CLINICA



Scarico 1"1/4

RICAMBI (PAG. 56-69)

3101070 - Leva clinica

3101074 - Cartuccia

codice	UM	min. ord.	conf.	cat.	prezzo (€)
● 3003019	NR	1	10	03	

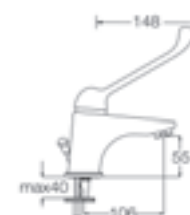

LAVABO "BIG SIZE"



Scarico 1"1/4

RICAMBI (PAG. 56-69)

3101075 - Maniglia

3101074 - Cartuccia

codice	UM	min. ord.	conf.	cat.	prezzo (€)
● 3003011	NR	1	10	03	

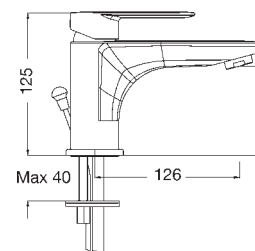

BIDET



Scarico 1"1/4

RICAMBI (PAG. 56-69)

3101075 - Maniglia

3101074 - Cartuccia

codice	UM	min. ord.	conf.	cat.	prezzo (€)
● 3003012	NR	1	10	03	

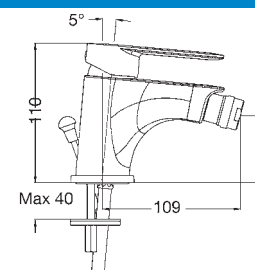

BIDET "BIG SIZE"



Scarico 1"1/4

RICAMBI (PAG. 56-69)

3101075 - Maniglia

3101074 - Cartuccia

2751200 - Aeratore cachè

codice	UM	min. ord.	conf.	cat.	prezzo (€)
● 3003020	NR	1	10	03	

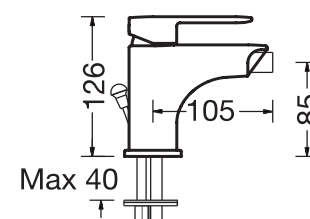

DOCCIA INCASSO CON DEVIATORE

Incluso corpo incasso



RICAMBI (PAG. 56-69)

3101075 - Maniglia

3101076 - Cartuccia

codice	UM	min. ord.	conf.	cat.	prezzo (€)
● 3003013	NR	1	14	03	

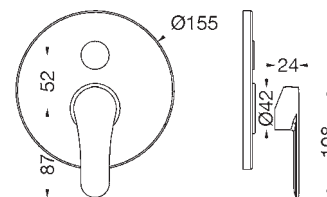

DOCCIA INCASSO

Incluso corpo incasso



RICAMBI (PAG. 56-69)

3101075 - Maniglia

3101076 - Cartuccia

3101081 - Placca

codice	UM	min. ord.	conf.	cat.	prezzo (€)
● 3003014	NR	1	22	03	

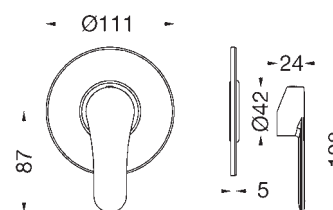

DOCCIA ESTERNO



RICAMBI (PAG. 56-69)

3101075 - Maniglia

3101074 - Cartuccia

codice	UM	min. ord.	conf.	cat.	prezzo (€)
● 3003015	NR	1	14	03	

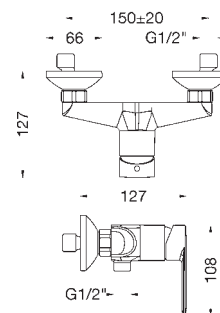

VASCA CON KIT DOCCIA

Flessibile cm. 150



RICAMBI (PAG. 56-69)

3101075 - Maniglia

3101074 - Cartuccia

codice	UM	min. ord.	conf.	cat.	prezzo (€)
● 3003016	NR	1	6	03	

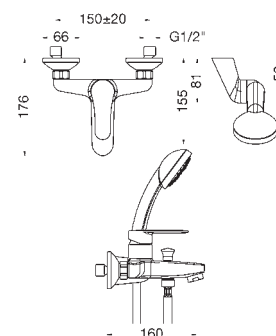

RUBINETTERIA CROMATA

Serie DELFINO DUE

La serie DELFINO DUE dispone di una cartuccia da 40 mm.

LAVABO



Scarico 1"1/4

RICAMBI (PAG. 56-69)

3101064 - Maniglia
3101060 - Cartuccia

codice	UM	min. ord.	conf.	cat.	prezzo (€)
● 3004001	NR	1	10	11	

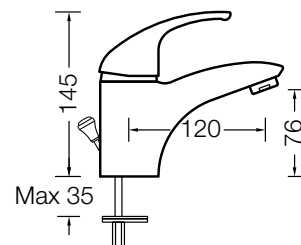

LAVABO LEVA CLINICA



Scarico 1"1/4

RICAMBI (PAG. 56-69)

3101004 - Leva clinica
3101060 - Cartuccia

codice	UM	min. ord.	conf.	cat.	prezzo (€)
● 3004009	NR	1	10	03	

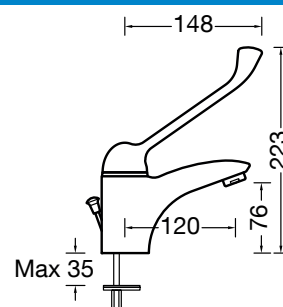

LAVABO BOCCA ESTRAIBILE



Scarico 1"1/4

RICAMBI (PAG. 56-69)

3101114 - Maniglia
3101112 - Cartuccia
3101096 - Bocca erogazione
3101111 - Flessibile

codice	UM	min. ord.	conf.	cat.	prezzo (€)
● 3006001	NR	1	1	11	

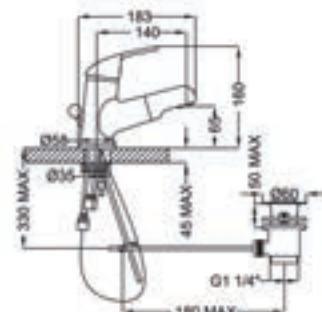

BIDET



Scarico 1"1/4

RICAMBI (PAG. 56-69)

3101064 - Maniglia
3101059 - Cartuccia

codice	UM	min. ord.	conf.	cat.	prezzo (€)
● 3004002	NR	1	10	11	

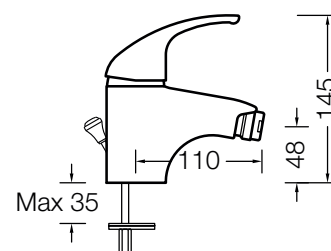

DOCCIA INCASSO CON DEVIATORE

Incluso corpo incasso



RICAMBI (PAG. 56-69)
3101064 - Maniglia
3101059 - Cartuccia

codice	UM	min. ord.	conf.	cat.	prezzo (€)
● 3004012	NR	1	14	11	

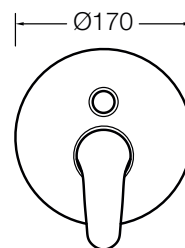

DOCCIA INCASSO

Incluso corpo incasso



RICAMBI (PAG. 56-69)
3101064 - Maniglia
3101059 - Cartuccia
3101020 - Prolunga
3101065 - Placca

codice	UM	min. ord.	conf.	cat.	prezzo (€)
● 3004003	NR	1	22	11	

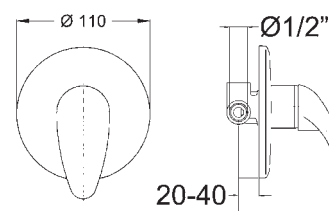

DOCCIA ESTERNO



RICAMBI (PAG. 56-69)
3101064 - Maniglia
3101059 - Cartuccia

codice	UM	min. ord.	conf.	cat.	prezzo (€)
● 3004004	NR	1	12	11	

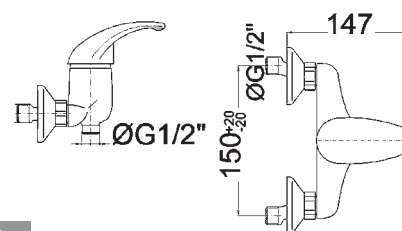

VASCA CON KIT DOCCIA

Flessibile cm. 150



RICAMBI (PAG. 56-69)
3101064 - Maniglia
3101059 - Cartuccia

codice	UM	min. ord.	conf.	cat.	prezzo (€)
● 3004005	NR	1	8	11	

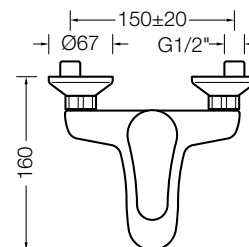

RUBINETTERIA CROMATA

Serie GROHE EUROSTYLE

LAVABO

Scarico 1"1/4



RICAMBI (PAG. 56-69)
46374000 - Cartuccia

codice	UM	min. ord.	conf.	cat.	prezzo (€)
● 23707003	NR	1	16	17	

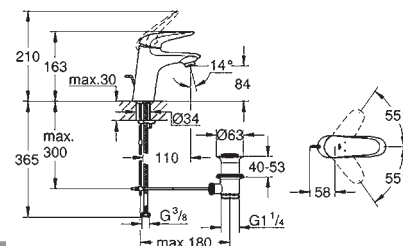

BIDET

Scarico 1"1/4



RICAMBI (PAG. 56-69)
46374000 - Cartuccia

codice	UM	min. ord.	conf.	cat.	prezzo (€)
● 23720003	NR	1	16	17	

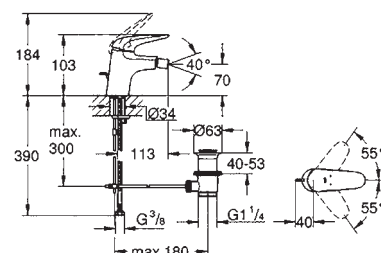

DOCCIA INCASSO CON DEVIATORE

Incluso corpo incasso



RICAMBI (PAG. 56-69)
46048000 - Cartuccia

codice	UM	min. ord.	conf.	cat.	prezzo (€)
● 23730003	NR	1	9	17	

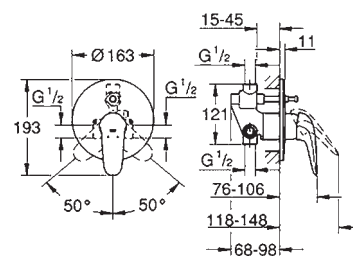

DOCCIA INCASSO

Incluso corpo incasso



RICAMBI (PAG. 56-69)
46048000 - Cartuccia

codice	UM	min. ord.	conf.	cat.	prezzo (€)
● 23725003	NR	1	9	17	

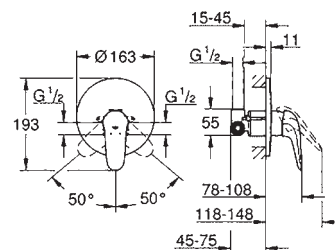

DOCCIA ESTERNO

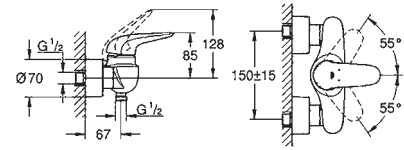

RICAMBI (PAG. 56-69)
46374000 - Cartuccia

codice	UM	min. ord.	conf.	cat.	prezzo (€)
● 23722003	NR	1	12	17	

VASCA CON KIT DOCCIA

Flessibile cm. 150

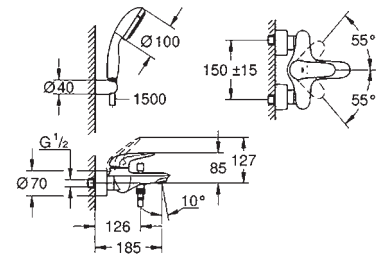

RICAMBI (PAG. 56-69)
46374000 - Cartuccia

codice	UM	min. ord.	conf.	cat.	prezzo (€)
● 2372930A	NR	1	9	17	

RUBINETTERIA CROMATA

Serie GROHE EUROSMART

LAVABO TAGLIA S

NOVITÀ!

5
l/min



Scarico 1"1/4

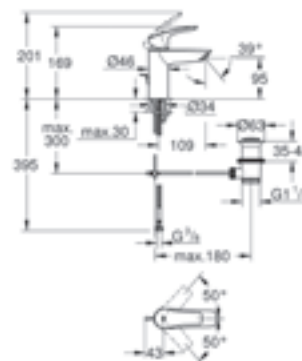

codice	UM	min. ord.	conf.	cat.	prezzo (€)
● 33265003	NR	1	8	17	

LAVABO BOCCA ALTA TAGLIA L

NOVITÀ!

5
l/min



Scarico 1"1/4

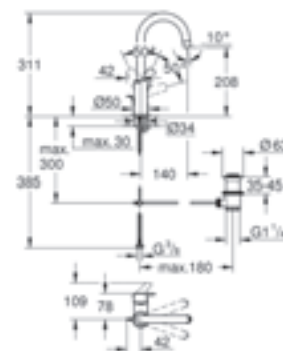

codice	UM	min. ord.	conf.	cat.	prezzo (€)
● 23537003	NR	1	12	17	

LAVABO TAGLIA M

NOVITÀ!

5
l/min



Scarico 1"1/4

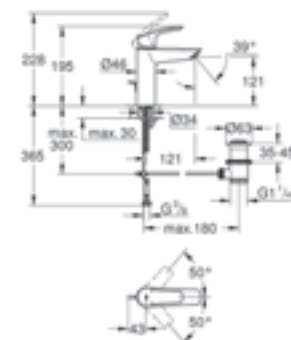

codice	UM	min. ord.	conf.	cat.	prezzo (€)
● 23322003	NR	1	8	17	

BIDET TAGLIA S

NOVITÀ!

5
l/min



Scarico 1"1/4

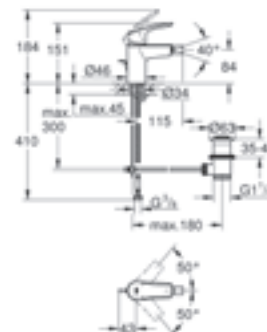

codice	UM	min. ord.	conf.	cat.	prezzo (€)
● 32929003	NR	1	8	17	

DOCCIA INCASSO CON DEVIATORE



NOVITÀ!

Incluso corpo incasso

RICAMBI (PAG. 56-69)
46048000 - Cartuccia

codice	UM	min. ord.	conf.	cat.	prezzo (€)
● 33305003	NR	1	9	17	

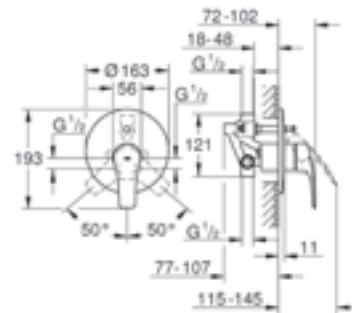

DOCCIA INCASSO



NOVITÀ!

Incluso corpo incasso

RICAMBI (PAG. 56-69)
46048000 - Cartuccia

codice	UM	min. ord.	conf.	cat.	prezzo (€)
● 33556003	NR	1	9	17	

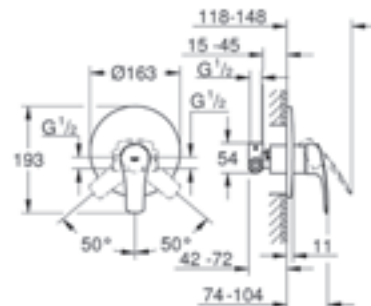

DOCCIA ESTERNO



NOVITÀ!

RICAMBI (PAG. 56-69)
46374000 - Cartuccia

codice	UM	min. ord.	conf.	cat.	prezzo (€)
● 33555003	NR	1	12	17	



VASCA CON KIT DOCCIA



NOVITÀ!

Flessibile cm. 150

RICAMBI (PAG. 56-69)
46374000 - Cartuccia

codice	UM	min. ord.	conf.	cat.	prezzo (€)
● 33302003	NR	1	9	17	

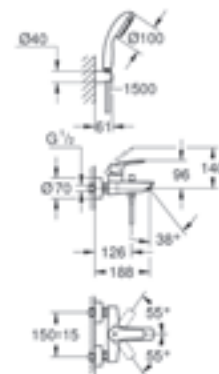

RUBINETTERIA CROMATA

Serie EVA

LAVABO MONOFORO

Scarico 1"1/4



RICAMBI (PAG. 56-69)
3101057 - Maniglia
3101032 - Vitone ceramico

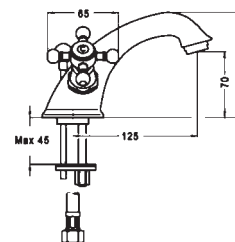

codice	UM	min. ord.	conf.	cat.	prezzo (€)
● 3007001	NR	1	8	05	

LAVABO MONOFORO ALTO cm.11

Scarico 1"1/4



RICAMBI (PAG. 56-69)
3101057 - Maniglia
3101032 - Vitone ceramico

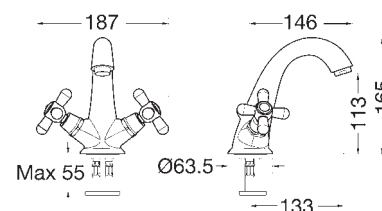

codice	UM	min. ord.	conf.	cat.	prezzo (€)
● 3007024	NR	1	1	05	

LAVABO MONOFORO COLLO CIGNO

Scarico 1"1/4



RICAMBI (PAG. 56-69)
3101057 - Maniglia
3101032 - Vitone ceramico



codice	UM	min. ord.	conf.	cat.	prezzo (€)
● 3007002	NR	1	8	05	

LAVABO 3 FORI

Scarico 1"1/4



RICAMBI (PAG. 56-69)
3101057 - Maniglia
3101032 - Vitone ceramico

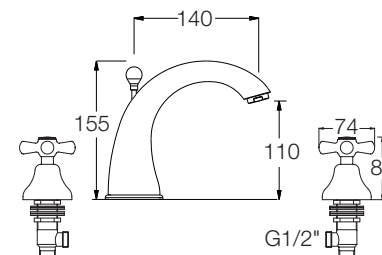

codice	UM	min. ord.	conf.	cat.	prezzo (€)
● 3007003	NR	1	8	05	

LAVABO 3 FORI

Scarico 1"1/4



RICAMBI (PAG. 56-69)
3101057 - Maniglia
3101032 - Vitone ceramico

codice	UM	min. ord.	conf.	cat.	prezzo (€)
● 3007004	NR	1	8	05	

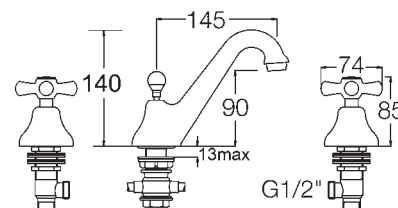

LAVABO 3 FORI COLLO CIGNO

Scarico 1"1/4



RICAMBI (PAG. 56-69)
3101057 - Maniglia
3101032 - Vitone ceramico

codice	UM	min. ord.	conf.	cat.	prezzo (€)
● 3007005	NR	1	8	05	

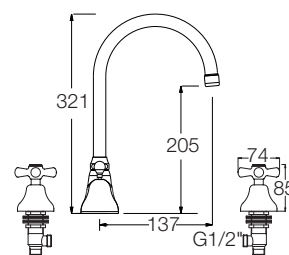

BIDET MONOFORO

Scarico 1"1/4



RICAMBI (PAG. 56-69)
3101057 - Maniglia
3101032 - Vitone ceramico

codice	UM	min. ord.	conf.	cat.	prezzo (€)
● 3007006	NR	1	8	05	

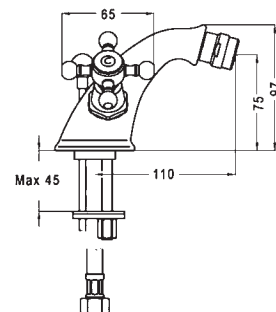

BIDET 3 FORI

Scarico 1"1/4



RICAMBI (PAG. 56-69)
3101057 - Maniglia
3101032 - Vitone ceramico

codice	UM	min. ord.	conf.	cat.	prezzo (€)
● 3007007	NR	1	10	05	

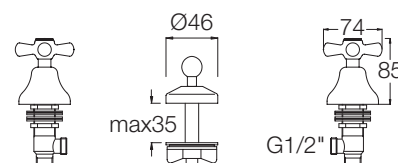

RUBINETTERIA CROMATA

Serie EVA

BIDET 3 FORI CON EROGAZIONE

Scarico 1"1/4



RICAMBI (PAG. 56-69)
3101057 - Maniglia
3101032 - Vitone ceramico

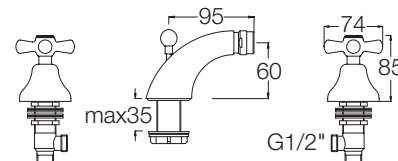

codice	UM	min. ord.	conf.	cat.	prezzo (€)
● 3007008	NR	1	1	05	

VASCA CON KIT DOCCIA

Flessibile cm. 150



RICAMBI (PAG. 56-69)
3101057 - Maniglia
3101032 - Vitone ceramico
1412003 - Doccetta

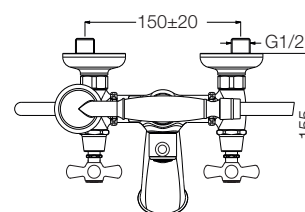

codice	UM	min. ord.	conf.	cat.	prezzo (€)
● 3007009	NR	1	8	05	

RUBINETTO INCASSO D. 1/2", SEDE ESTRAIBILE

Con placchetta caldo/freddo



RICAMBI (PAG. 56-69)
3101057 - Maniglia
3101032 - Vitone ceramico

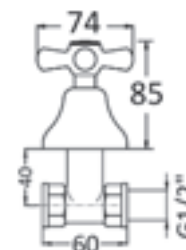

codice	UM	min. ord.	conf.	cat.	prezzo (€)
● 3007023	NR	1	44	05	

LAVABO MONOFORO

Scarico 1"1/4



RICAMBI (PAG. 56-69)
3101054 - Maniglia
3101031 - Vitone

codice	UM	min. ord.	conf.	cat.	prezzo (€)
● 3005001	NR	1	1	05	

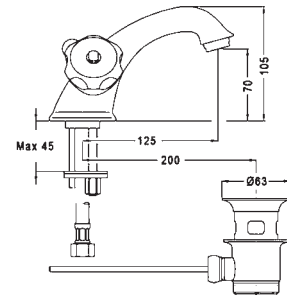

LAVABO 3 FORI

Scarico 1"1/4



RICAMBI (PAG. 56-69)
3101054 - Maniglia
3101031 - Vitone

codice	UM	min. ord.	conf.	cat.	prezzo (€)
● 3005008	NR	1	10	05	

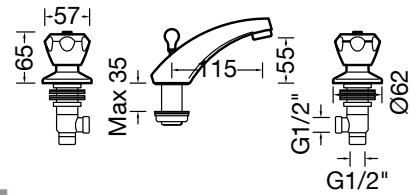

LAVABO 3 FORI SENZA SCARICO



RICAMBI (PAG. 56-69)
3101054 - Maniglia
3101031 - Vitone

codice	UM	min. ord.	conf.	cat.	prezzo (€)
● 3005020	NR	1	12	05	

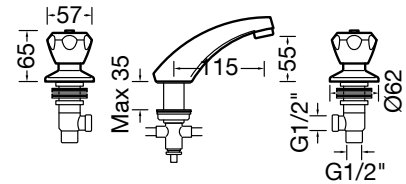

BIDET MONOFORO

Scarico 1"1/4



RICAMBI (PAG. 56-69)
3101054 - Maniglia
3101031 - Vitone

codice	UM	min. ord.	conf.	cat.	prezzo (€)
● 3005002	NR	1	1	05	

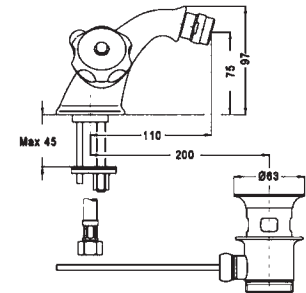

BIDET 3 FORI

Scarico 1"1/4



RICAMBI (PAG. 56-69)
3101054 - Maniglia
3101031 - Vitone

codice	UM	min. ord.	conf.	cat.	prezzo (€)
● 3005009	NR	1	10	05	

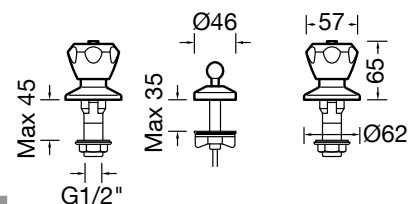

RUBINETTERIA CROMATA

Serie TRADIZIONALE

RUBINETTO BIDET



RICAMBI (PAG. 56-69)
3101054 - Maniglia
3101031 - Vitone

codice	UM	min. ord.	conf.	cat.	prezzo (€)
● 3005004	NR	2	44	05	

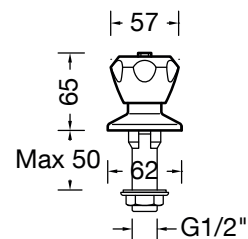

VASCA CON KIT DOCCIA



Flessibile cm. 150

RICAMBI (PAG. 56-69)
3101054 - Maniglia
3101031 - Vitone

codice	UM	min. ord.	conf.	cat.	prezzo (€)
● 3005003	NR	1	14	05	

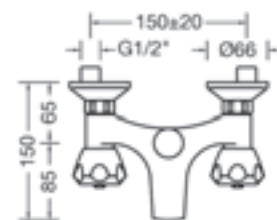

VASCA CON KIT DOCCIA



RICAMBI (PAG. 56-69)
3101054 - Maniglia
3101031 - Vitone

codice	UM	min. ord.	conf.	cat.	prezzo (€)
● 3005029	NR	1	1	05	

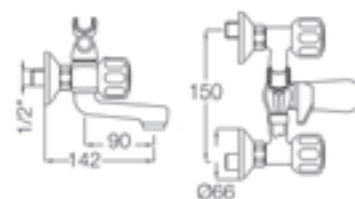

RUBINETTO PARETE



RICAMBI (PAG. 56-69)
3101054 - Maniglia
3101031 - Vitone

codice	UM	min. ord.	conf.	cat.	prezzo (€)
● 3005016	NR	2	44	05	

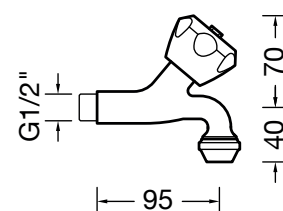

RUBINETTO EROGAZIONE SINGOLA D. 1/2"



RICAMBI (PAG. 56-69)
3101054 - Maniglia
3101031 - Vitone

codice	UM	min. ord.	conf.	cat.	prezzo (€)
● 3005021	NR	2	44	05	

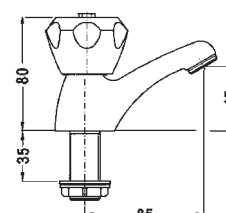

Serie TRADIZIONALE

RUBINETTO SINGOLO



RICAMBI (PAG. 56-69)
3101054 - Maniglia
3101031 - Vitone

codice	UM	min. ord.	conf.	cat.	prezzo (€)
● 3005026	NR	1	10	05	



RUBINETTO INCASSO D. 1/2"



RICAMBI (PAG. 56-69)
3101054 - Maniglia
3101031 - Vitone

codice	UM	min. ord.	conf.	cat.	prezzo (€)
● 3005005	NR	2	44	05	

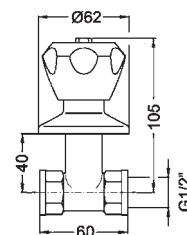

RUBINETTERIA ELETTRONICA

GROHE EUROSMART COSMOPOLITAN E

Miscelatore elettronico con comando ad infrarossi e limitatore di temperatura regolabile. Batteria litio 6V. Corpo in ottone.



codice	UM	min. ord.	conf.	cat.	prezzo (€)
● 36327001	NR	1	12	13	

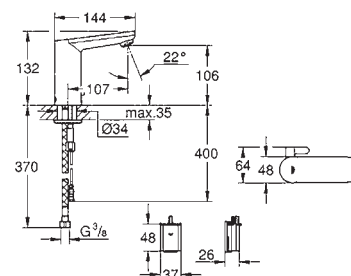

GROHE BAU COSMO E

Miscelatore elettronico con comando ad infrarossi e limitatore di temperatura regolabile, batteria litio 6V. Corpo in polimero composito.



codice	UM	min. ord.	conf.	cat.	prezzo (€)
● 36451000	NR	1	20	10	

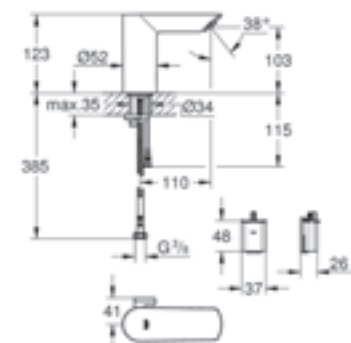

RUBINETTERIA CROMATA

CORPI INCASSO UNIVERSALI

GROHE RAPIDO SMARTBOX CORPO INCASSO UNIVERSALE



Per miscelatori Smartcontrol e per tutte le serie ad incasso Grohe.

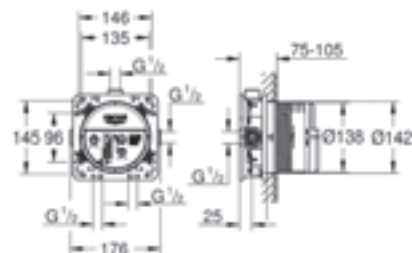

codice	UM	min. ord.	conf.	cat.	prezzo (€)
● 35604000	NR	1	12	13	

DADO/TONDA CORPO INCASSO 2 VIE



Con protezione.
Solo per la finitura cromo.

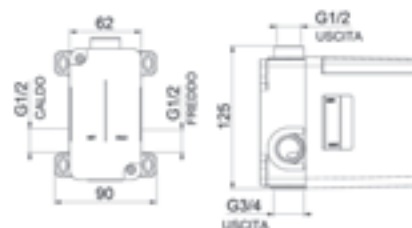

codice	UM	min. ord.	conf.	cat.	prezzo (€)
● 3005102	NR	1	1	11	

DADO/TONDA CORPO INCASSO 1 VIA



Con protezione.
Solo per la finitura cromo.

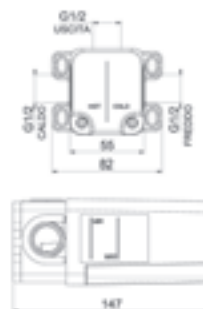

codice	UM	min. ord.	conf.	cat.	prezzo (€)
● 3005101	NR	1	1	11	

GROHE BLUE HOME STARTER KIT

Set composto da: miscelatore monocomando cromato per lavello con sistema filtrante dell'acqua, bocca girevole con angolo di rotazione 150° con n.2 canali di erogazione separati (uno per acqua corrente miscelata, uno per acqua filtrata), pulsante a pressione per 3 tipologie di acqua fresca e filtrata (acqua naturale fresca, leggermente frizzante e frizzante fresca).

Grohe Blue refrigeratore da 180 Watt, 230 V, 50 Hz.

Grohe Blue bombola CO2 da 425 gr.

Grohe Blue filtro BWT a 5 fasi con capacità media di 600 litri (40404001) oppure un anno di utilizzo: elimina le sostanze che alterano l'odore e il sapore dell'acqua (come il cloro e composti organici), riduce il calcare e diminuisce il residuo fisso.

Comunicazione dati wireless con Bluetooth 4.0 e interfaccia WIFI (per sistemi Apple e Android) per monitoraggio filtro e bombola di CO2.

NOVITÀ!

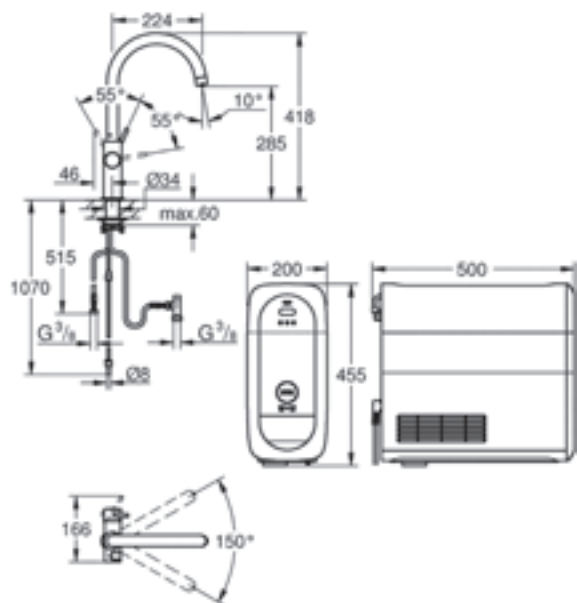

codice	UM	min. ord.	conf.	cat.	prezzo (€)
● 115556	NR	1	1	13	

GROHE BLUE FILTRO BWT



codice	capacità media	altezza (H)	UM	min. ord.	conf.	cat.	prezzo (€)
● 40404001	600 litri	234	NR	1	32	13	
● 40430001	1.500 litri	315	NR	1	24	13	



RUBINETTERIA CROMATA

FILTRAZIONE ACQUA POTABILE

KIT DELO' PUR



Sistema di filtrazione che rende gradevole l'acqua di casa.

La cartuccia permette una microfiltrazione meccanica e chimica di assorbimento tramite il sistema Carbon Block, per trattene impurità superiori a 0,5 µm.

Il sistema Carbon Block impregnato di sali d'argento impedisce a batteri e virus di proliferare all'interno del filtro.

Il kit Delò Pur trattiene:

- cloro e derivati
- sostanze organiche
- composti di metalli
- composti organo-alogenati

Il kit Delò Pur è composto da:

n.1 miscelatore GIULIO 3 acque (3001000), con due canali di erogazione separati e due maniglie (uno per l'acqua corrente, l'altro per l'acqua filtrata)

n.1 kit filtraggio (2006099) che comprende:

testata porta cartuccia con staffa e ghiera, cartuccia da 15.000 litri riferita a 1 ppm di cloro (2006098), contaltri, 2,5 m di tubo da 8x6, presa d'acqua MF 3/8", raccorderia per l'installazione.

Tecnologia conforme al D.M.174/4.

L'apparecchiatura deve essere installata nel rispetto delle norme locali vigenti e dal D.M. Salute 25/2012 e necessita di regolare manutenzione periodica per garantire i requisiti di potabilità (almeno una volta all'anno).

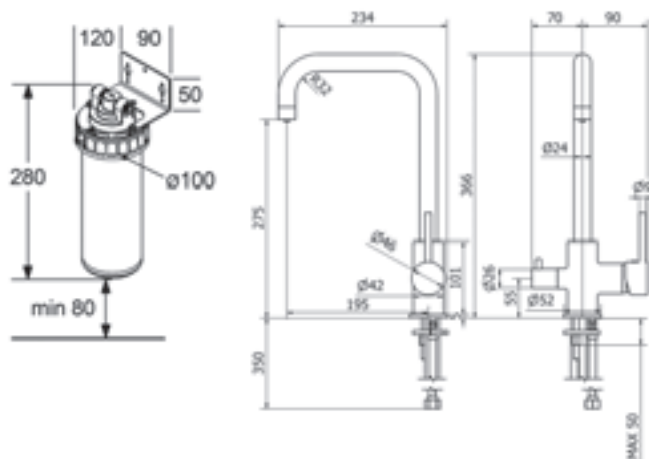

DATI TECNICI

Corpo del filtro	polipropilene
Autonomia cartuccia	15.000 lt/anno
Portata a 0,2 bar	4 lt/min.
Portata max	6 lt/min.
PN	8,6 bar
Filtrazione	0,5 µm
Temperatura max	39°C

COMPOSIZIONE

codice	descrizione	UM	min. ord.	conf.	cat.	prezzo (€)
● 3001000	GIULIO miscelatore	NR	1	11		
● 2006099	Kit filtraggio	NR	1	11		

CARTUCCIA PER KIT DELO' PUR

Capacità 15.000 litri/anno.

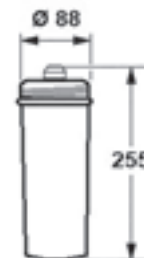
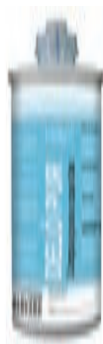

codice	descrizione	UM	min. ord.	conf.	cat.	prezzo (€)
● 2006098	cartuccia di ricambio	NR	1	6	03	

GROHE BLUE PURE EUROSART STARTER KIT

Set composto da: miscelatore monocomando cromato per lavello con sistema filtrante dell'acqua, maniglia separata per l'erogazione dell'acqua filtrata, bocca girevole con angolo di rotazione 150°. N.2 canali di erogazione separati (uno per acqua corrente miscelata, uno per acqua filtrata), Grohe Blue filtro BWT a 5 fasi con capacità media di 600 litri (40404001) oppure un anno di utilizzo. Elimina le sostanze che alterano l'odore e il sapore dell'acqua (come il cloro e composti organici), riduce il calcare e diminuisce il residuo fisso. Contalibri con allarme acustico per cambio filtro.

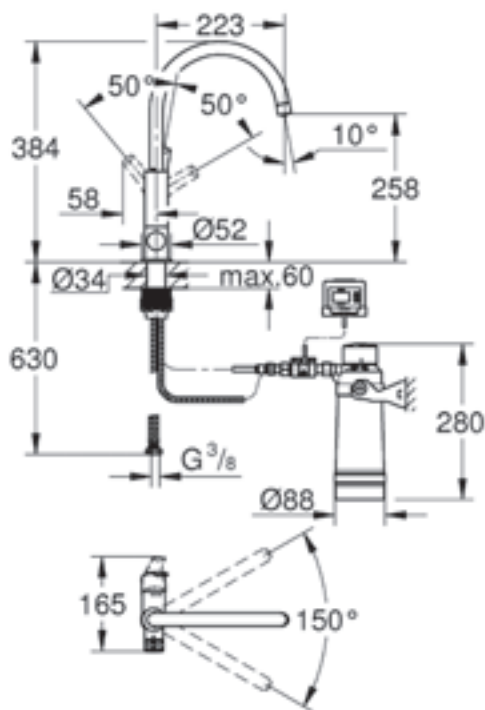

codice	UM	min. ord.	conf.	cat.	prezzo (€)
● 30499000	NR	1	2	13	

GROHE BLUE FILTRO BWT



codice	capacità media	altezza (H)	UM	min. ord.	conf.	cat.	prezzo (€)
● 40404001	600 litri	234	NR	1	32	13	
● 40430001	1.500 litri	315	NR	1	24	13	



RUBINETTERIA CROMATA

RUBINETTERIA DA CUCINA

AMEDEO LAVELLO CON CANNA FLESSIBILE GOMMA NERA



Canna flessibile da 500 mm., D.20,5 mm., composta da: flessibile interno in PVC, maglia in acciaio e rivestimento esterno in silicone.

RICAMBI (PAG. 56-69)

3101110 - Bocca erogazione (versione cromo)

3101100 - Cartuccia

2751060 - Aeratore

codice	finitura	UM	min. ord.	conf.	cat.	prezzo (€)
● 3005050	cromo	NR	1	5	03	
● 3005950	nero opaco	NR	1	1	03	

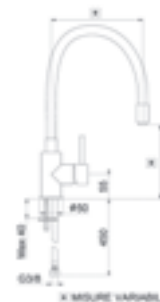

AMEDEO LAVELLO CON CANNA FLESSIBILE GOMMA BIANCA



Canna flessibile da 500 mm., D.20,5 mm., composta da: flessibile interno in PVC, maglia in acciaio e rivestimento esterno in silicone.

RICAMBI (PAG. 56-69)

3101109 - Bocca erogazione (versione cromo)

3101100 - Cartuccia

2751060 - Aeratore

codice	finitura	UM	min. ord.	conf.	cat.	prezzo (€)
● 3005051	cromo	NR	1	5	03	
● 3005751	bianco opaco	NR	1	1	03	



GIULIO LAVELLO 3 ACQUE



Con deviatore per acqua filtrata, uscita separata.

RICAMBI (PAG. 56-69)

3101115 - Maniglia

3101113 - Cartuccia

3101120 - Aeratore cachè

codice	UM	min. ord.	conf.	cat.	prezzo (€)
● 3001000	NR	1	1	11	

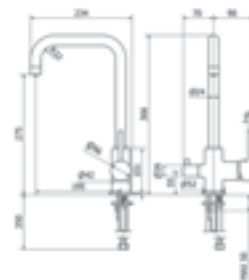

LAVELLO SOTTOFINESTRA



Altezza minima 8 cm.

RICAMBI (PAG. 56-69)

3101116 - Maniglia

3101112 - Cartuccia

codice	UM	min. ord.	conf.	cat.	prezzo (€)
● 1434001	NR	1	1	03	

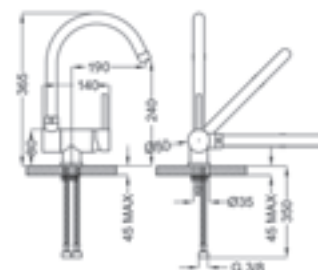

EDO LAVELLO DOCCETTA ESTRAIBILE 2 GETTI



Molla fissa, doccetta estraibile.

RICAMBI (PAG. 56-69)

3101069 - Cartuccia

codice	UM	min. ord.	conf.	cat.	prezzo (€)
● 3009015	NR	1	1	03	

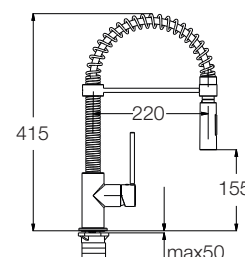

RUBINETTERIA DA CUCINA

MAYA LAVELLO DOCCETTA ORIENTABILE 2 GETTI



Sganciando la doccetta dal supporto si utilizza la flessibilità della molla

RICAMBI (PAG. 56-69)

3008913 - Maniglia

3008905 - Cartuccia

3008911 - Doccetta (2 getti c/ritorno automatico)

codice	UM	min. ord.	conf.	cat.	prezzo (€)
● 3008034	NR	1	6	03	

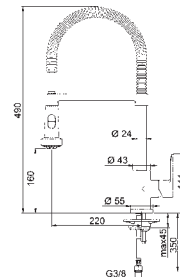

LAVELLO DOCCETTA ESTRAIBILE 2 GETTI



RICAMBI (PAG. 56-69)

3101114 - Maniglia

3101112 - Cartuccia

1413028 - Doccetta

3101111 - Flessibile

codice	UM	min. ord.	conf.	cat.	prezzo (€)
● 1434007	NR	1	1	03	



TONDA LAVELLO COLLO CIGNO



RICAMBI (PAG. 56-69)

3101100 - Cartuccia

3101138 - Bocca erogazione



codice	finitura	UM	min. ord.	conf.	cat.	prezzo (€)
● 3021025	cromo	NR	1	5	03	
● 3021925	nero opaco	NR	1	1	03	
● 3021825	simil acciaio	NR	1	1	03	

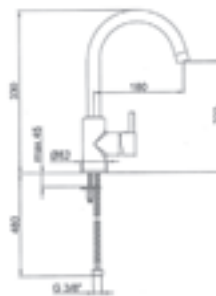

ZERO LAVELLO PIEGA TONDA



RICAMBI (PAG. 56-69)

3008905 - Cartuccia

codice	UM	min. ord.	conf.	cat.	prezzo (€)
● 3008810	NR	1	10	03	



RUBINETTERIA CROMATA

RUBINETTERIA DA CUCINA

MAYA LEVELLO COLLO CIGNO



RICAMBI (PAG. 56-69)
3008913 - Maniglia
3008905 - Cartuccia

codice	UM	min. ord.	conf.	cat.	prezzo (€)
● 3008032	NR	1	6	03	

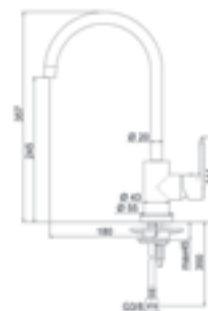

GROHE EUROSMART LEVELLO COLLO CIGNO



RICAMBI (PAG. 56-69)
46374000 - Cartuccia

codice	UM	min. ord.	conf.	cat.	prezzo (€)
● 33202003	NR	1	12	17	

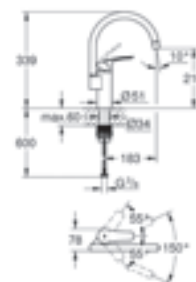

GROHE BAUEDGE LEVELLO BOCCA GIREVOLE



codice	UM	min. ord.	conf.	cat.	prezzo (€)
● 31367001	NR	1	12	11	

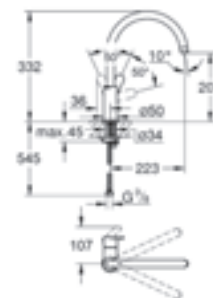

EVA LEVELLO MONOFORO COLLO CIGNO



RICAMBI (PAG. 56-69)
3101057 - Maniglia
3101032 - Cartuccia
3101084 - Bocca erogazione

codice	UM	min. ord.	conf.	cat.	prezzo (€)
● 3007018	NR	1	8	05	

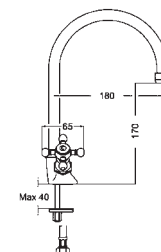

TRADIZIONALE LEVELLO MONOFORO COLLO CIGNO



RICAMBI (PAG. 56-69)
3101054 - Maniglia
3101031 - Vitone

codice	UM	min. ord.	conf.	cat.	prezzo (€)
● 3005012	NR	1	10	05	

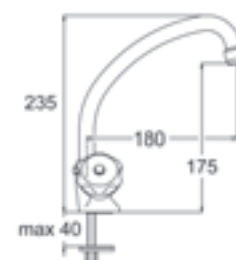

RUBINETTERIA DA CUCINA

PIETRO LAVELLO BOCCA GIREVOLE



RICAMBI (PAG. 56-69)
3101069 - Cartuccia

codice	UM	min. ord.	conf.	cat.	prezzo (€)
● 1434013	NR	1	1	03	

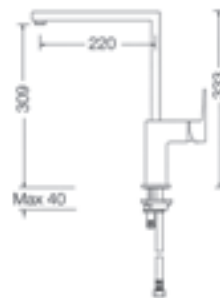

TONDA LAVELLO BOCCA GIREVOLE



RICAMBI (PAG. 56-69)
3101100 - Cartuccia

codice	finitura	UM	min. ord.	conf.	cat.	prezzo (€)
● 3021023	cromo	NR	1	5	03	
● 3021923	nero opaco	NR	1	1	03	
● 3021823	simil acciaio	NR	1	1	03	

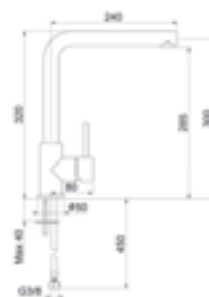

TONDA LAVELLO DOCCETTA ESTRAIBILE 1 GETTO



RICAMBI (PAG. 56-69)
3101100 - Cartuccia

codice	finitura	UM	min. ord.	conf.	cat.	prezzo (€)
● 3021024	cromo	NR	1	5	03	
● 3021924	nero opaco	NR	1	1	03	
● 3021824	simil acciaio	NR	1	1	03	

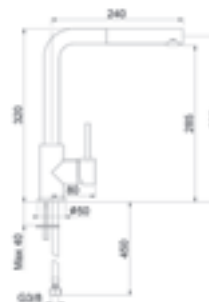

MAYA LAVELLO BOCCA GIREVOLE



RICAMBI (PAG. 56-69)
3008913 - Maniglia
3008905 - Cartuccia

codice	UM	min. ord.	conf.	cat.	prezzo (€)
● 3008033	NR	1	6	03	

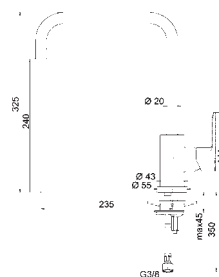

RUBINETTERIA CROMATA

RUBINETTERIA DA CUCINA

ELIO LAVELLO PIEGA TONDA



RICAMBI (PAG. 56-69)
3008922 - Maniglia
3008920 - Cartuccia

codice	UM	min. ord.	conf.	cat.	prezzo (€)
● 3008850	NR	1	10	03	

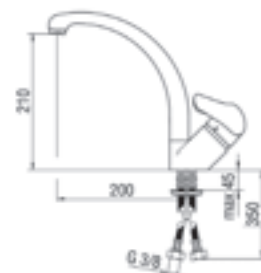

DELFINO DUE LAVELLO PIEGA TONDA



RICAMBI (PAG. 56-69)
3101064 - Maniglia
3101059 - Cartuccia
3101090 - Bocca erogazione

codice	UM	min. ord.	conf.	cat.	prezzo (€)
● 3004010	NR	1	10	03	

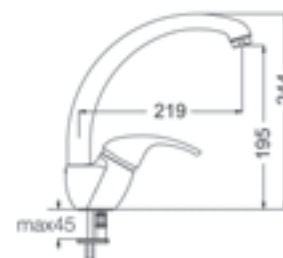

ZERO LAVELLO BOCCA GIREVOLE



RICAMBI (PAG. 56-69)
3008904 - Cartuccia
2751060 - Aeratore

codice	UM	min. ord.	conf.	cat.	prezzo (€)
● 3008808	NR	1	10	03	



DELFINO DUE LAVELLO



RICAMBI (PAG. 56-69)
3101098 - Cartuccia

codice	UM	min. ord.	conf.	cat.	prezzo (€)
● 3004006	NR	1	12	03	

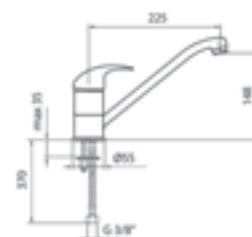

RUBINETTERIA CROMATA

RUBINETTERIA DA CUCINA

TRADIZIONALE LEVELLO PARETE



RICAMBI (PAG. 56-69)
3101054 - Maniglia
3101031 - Vitone

codice	UM	min. ord.	conf.	cat.	prezzo (€)
● 3005010	NR	1	20	05	

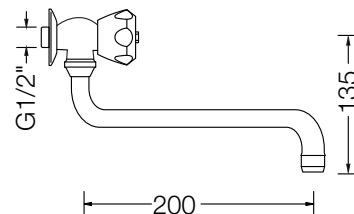

TRADIZIONALE LEVELLO PARETE BOCCA ALTA GIREVOLE



RICAMBI (PAG. 56-69)
3101054 - Maniglia
3101031 - Vitone

codice	UM	min. ord.	conf.	cat.	prezzo (€)
● 3005025	NR	1	20	05	

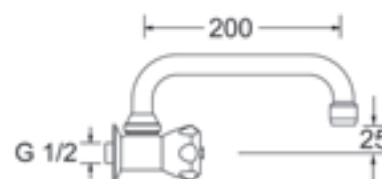

TRADIZIONALE LEVELLO PARETE CON DEVIATORE E ATTACCO LAVATRICE



RICAMBI (PAG. 56-69)
3101054 - Maniglia
3101031 - Vitone

codice	UM	min. ord.	conf.	cat.	prezzo (€)
● 3005027	NR	1	12	05	

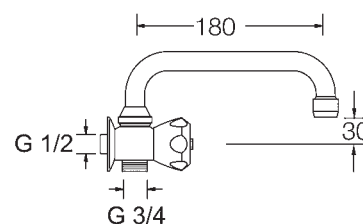

TRADIZIONALE RUBINETTO SINGOLO PARETE



RICAMBI (PAG. 56-69)
3101054 - Maniglia
3101031 - Vitone

codice	UM	min. ord.	conf.	cat.	prezzo (€)
● 3005014	NR	1	16	05	

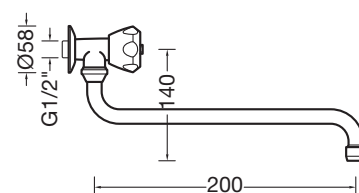

TRADIZIONALE RUBINETTO PER SCALDABAGNO

Incluso tubo di collegamento



codice	UM	min. ord.	conf.	cat.	prezzo (€)
● 3005028	NR	1	20	03	

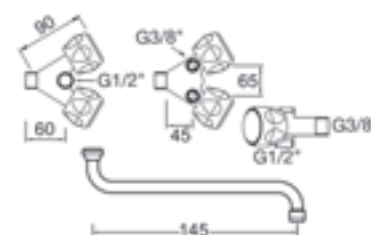

RUBINETTERIA LEVA CLINICA

ZERO LAVABO LEVA CLINICA



Scarico 1"1/4

RICAMBI (PAG. 56-69)
3008901 - Leva clinica
3008915 - Cartuccia
2751060 - Aeratore

codice	UM	min. ord.	conf.	cat.	prezzo (€)
● 3008802	NR	1	10	03	

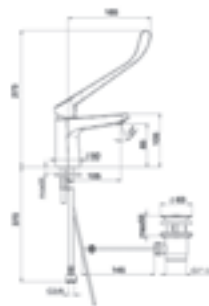

NEMO LAVABO LEVA CLINICA

NOVITÀ!



Scarico 1"1/4

RICAMBI (PAG. 56-69)
3101070 - Leva clinica
3101074 - Cartuccia

codice	UM	min. ord.	conf.	cat.	prezzo (€)
● 3003019	NR	1	10	03	

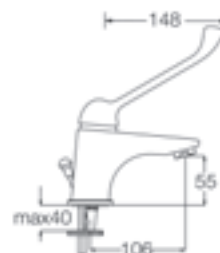

DELFINO DUE LAVABO LEVA CLINICA



Scarico 1"1/4

RICAMBI (PAG. 56-69)
3101004 - Leva clinica
3101060 - Cartuccia

codice	UM	min. ord.	conf.	cat.	prezzo (€)
● 3004009	NR	1	10	03	

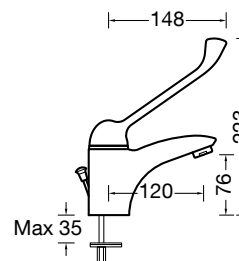

DELFINO UNO LAVELLO LEVA CLINICA



RICAMBI (PAG. 56-69)
3101004 - Leva clinica
3101006 - Cartuccia

codice	UM	min. ord.	conf.	cat.	prezzo (€)
● 3002014	NR	1	10	03	

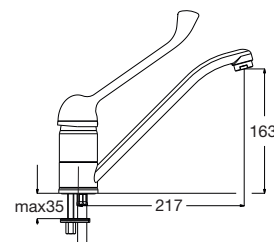

DELFINO UNO LAVELLO PARETE LEVA CLINICA



RICAMBI (PAG. 56-69)
3101004 - Leva clinica
3101006 - Cartuccia

codice	UM	min. ord.	conf.	cat.	prezzo (€)
● 3002013	NR	1	14	03	

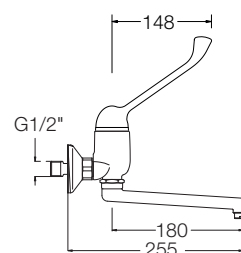

RICAMBI RUBINETTERIA CROMATA

CARTUCCE E VITONI

DADO CARTUCCIA

Fondo piatto

Compatibilità:

3001010 Lavabo
3001011 Lavabo alto
3001012 Bidet
3001018 Doccia esterno
3001017 Vasca con kit doccia



codice	∅	UM	min. ord.	conf.	cat.	prezzo (€)
● 3101097	mm 25 x 47,5 H	NR	1	1	09	

DADO/TONDA CARTUCCIA

Fondo piatto

Compatibilità:

3001013 Lavabo parete
3001014 Doccia incasso
3001015 Doccia incasso con deviatore
3001016 Doccia incasso 3 vie
3021013 Lavabo parete 2 pezzi
3021015 Doccia incasso
3021016 Doccia incasso con deviatore
3021018 Doccia incasso 3 vie
3004006 Lavello



codice	∅	UM	min. ord.	conf.	cat.	prezzo (€)
● 3101098	mm 42 x 63 H	NR	1	1	09	

TONDA CARTUCCIA

Fondo piatto

Compatibilità:

3021020 Doccia esterno



codice	∅	UM	min. ord.	conf.	cat.	prezzo (€)
● 3101099	mm 35 x 57 H	NR	1	1	09	

DADO/TONDA/AMEDEO CARTUCCIA

Fondo piatto

Compatibilità:

3001021 Lavello bocca girevole
3001022 Lavello doccetta estraibile
3021014 Lavabo parete piastra unica
3021017 Doccia incasso c/deviatore 2 vie
3021019 Vasca con kit doccia
3021023 Lavello bocca girevole
3021024 Lavello bocca doccetta estraibile
3021025 Lavello collo cigno
3005050 Lavello canna flessibile nera
3005051 Lavello canna flessibile bianca



codice	∅	UM	min. ord.	conf.	cat.	prezzo (€)
● 3101100	mm 35 x 56,5 H	NR	1	1	09	

TONDA CARTUCCIA

Fondo piatto

Compatibilità:

3021010 Lavabo
3021026 Lavabo
3021011 Lavabo alto
3021012 Bidet
3021027 Bidet
3021031 Vasca a pavimento



codice	∅	UM	min. ord.	conf.	cat.	prezzo (€)
● 3101101	mm 35 x 58 H	NR	1	1	09	

EDO CARTUCCIA

Cartuccia Keramital con fondo piatto e ghiera di regolazione antiscottatura. Apertura 60° + 60°



Compatibilità:

1430007 Doccia esterno per colonne doccia

codice	∅	UM	min. ord.	conf.	cat.	prezzo (€)
● 3101042	mm 35 x 55,2 H	NR	1	1	09	

NEMO CARTUCCIA

Cartuccia Keramital con distribuzione

Compatibilità:

3003010 Lavabo
3003019 Lavabo leva clinica
3003011 Lavabo "big size"
3003012 Bidet
3003020 Bidet "big size"
3003015 Doccia esterno
3003016 Vasca con kit doccia
1431015 Doccia esterno



codice	∅	UM	min. ord.	conf.	cat.	prezzo (€)
● 3101074	mm 35 x 68,4 H	NR	1	20	09	

EDO CARTUCCIA

Cartuccia Keramital con fondo piatto e ghiera di regolazione antiscottatura. Apertura 30° + 60°



Compatibilità:

3009015 Lavello con doccetta
1434013 Lavello bocca girevole

codice	∅	UM	min. ord.	conf.	cat.	prezzo (€)
● 3101069	mm 35 x 55,2 H	NR	1	1	09	

CARTUCCE E VITONI

MAYA CARTUCCIA

Con distribuzione e limitatore di temperatura



Compatibilità:
3008001 Lavabo
3008010 Lavabo "Big size"
3008002 Lavabo corpo alto
3008003 Bidet

codice	∅	UM	min. ord.	conf.	cat.	prezzo (€)
● 3008908	mm 35 x 70,2 H	NR	1	1	02	

MAYA/ZERO CARTUCCIA

Con distribuzione



Compatibilità:
3008802 Lavabo leva clinica

codice	∅	UM	min. ord.	conf.	cat.	prezzo (€)
● 3008915	mm 35 x 70 H	NR	1	1	02	

MAYA/ZERO CARTUCCIA

Fondo piatto



Compatibilità:
3008004 Doccia incasso
3008005 Doccia esterno
3008006 Doccia incasso con deviatore
3008805 Doccia incasso con deviatore
3008804 Doccia incasso
3008806 Doccia esterno
3008808 Lavello bocca girevole
3008809 Lavello parete

codice	∅	UM	min. ord.	conf.	cat.	prezzo (€)
● 3008904	mm 35 x 57,2 H	NR	1	1	02	

MAYA/ZERO CARTUCCIA

Con distribuzione, senza o-ring.

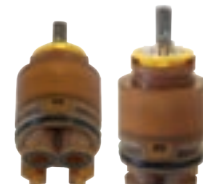

Compatibilità:
3008007 Vasca con kit doccia
3008032 Lavello collo cigno
3008033 Lavello bocca girevole
3008034 Lavello con doccetta
3008810 Lavello piega tonda

codice	∅	UM	min. ord.	conf.	cat.	prezzo (€)
● 3008905	mm 35 x 71,1 H	NR	1	1	02	

MAYA/ZERO CARTUCCIA

Con distribuzione



Compatibilità:
3008009 Lavabo "Maniglia standard"
3008011 Lavabo "Maniglia standard"
3008012 Bidet
3008801 Lavabo
3008803 Bidet
3008807 Vasca con kit doccia

codice	∅	UM	min. ord.	conf.	cat.	prezzo (€)
● 3008906	mm 35 x 70 H	NR	1	1	02	

DELFINO UNO CARTUCCIA

Cartuccia Keramital con distribuzione e ghiera di regolazione antiscottatura



codice	∅	UM	min. ord.	conf.	cat.	prezzo (€)
● 3101005	mm 40 x 74,1 H	NR	1	20	09	

DELFINO UNO CARTUCCIA

Cartuccia Keramital con fondo piatto e ghiera di regolazione antiscottatura



Compatibilità:
3002014 Lavello leva clinica
3002013 Lavello parete leva clinica

codice	∅	UM	min. ord.	conf.	cat.	prezzo (€)
● 3101006	mm 40 x 61,7 H	NR	1	20	09	

RICAMBI RUBINETTERIA CROMATA

CARTUCCE E VITONI

DELFINO DUE CARTUCCIA

Cartuccia Keramital con fondo piatto

Compatibilità:

- 3004002 Bidet
- 3004012 Doccia incasso con deviatore
- 3004003 Doccia incasso
- 3004004 Doccia esterno
- 3004005 Vasca con kit doccia
- 3004010 Lavello piega tonda
- 3004008 Lavello parete



codice	∅	UM	min. ord.	conf.	cat.	prezzo (€)
● 3101059	mm 40 x 61,6 H	NR	1	20	09	

DELFINO DUE CARTUCCIA

Cartuccia Keramital con distribuzione

Compatibilità:

- 3004001 Lavabo
- 3004009 Lavabo leva clinica



codice	∅	UM	min. ord.	conf.	cat.	prezzo (€)
● 3101060	mm 40 x 74,1 H	NR	1	20	09	

GROHE CARTUCCIA CERAMICA



codice	∅	UM	min. ord.	conf.	cat.	prezzo (€)
● 46580000	mm 28	NR	1	20	10	

GROHE CARTUCCIA CERAMICA



codice	∅	UM	min. ord.	conf.	cat.	prezzo (€)
● 46374000	mm 35	NR	1	20	10	

GROHE CARTUCCIA CERAMICA



codice	∅	UM	min. ord.	conf.	cat.	prezzo (€)
● 46048000	mm 46	NR	1	20	10	

CARTUCCIA



Compatibilità:

- 3006001 Lavabo bocca estraibile
- 1434001 Lavello sottofinestra
- 1434007 Lavello doccetta estraibile

codice	∅	UM	min. ord.	conf.	cat.	prezzo (€)
● 3101112	mm 40 x 63 H	NR	1	1	02	

GIULIO CARTUCCIA



Compatibilità:

- 3001000 Lavello 3 acque

codice	∅	UM	min. ord.	conf.	cat.	prezzo (€)
● 3101113	cm 35 x 70 H	NR	1	1	02	

ELIO CARTUCCIA



Compatibilità:

- 3008850 Lavello piega tonda

codice	∅	UM	min. ord.	conf.	cat.	prezzo (€)
● 3008920	mm 45 x 58 H	NR	1	1	02	

CARTUCCE E VITONI

CARTUCCIA DEVIATORE INCASSO 2 E 3 VIE

Cartuccia Keramital con fondo piatto



Compatibilità:

- 1431014 Deviatore incasso 2 vie
- 1431017 Deviatore incasso 3 vie

codice	∅	UM	min. ord.	conf.	cat.	prezzo (€)
● 3101072	mm 35 x 55,2 H	NR	1	1	09	

NEMO CARTUCCIA

Cartuccia Keramital con fondo piatto



Compatibilità:

- 3003013 Doccia incasso con deviatore
- 3003014 Doccia incasso

codice	∅	UM	min. ord.	conf.	cat.	prezzo (€)
● 3101076	mm 35 x 55,2 H	NR	1	1	09	

VITONE CERAMICO 90°

Fondo piatto



Compatibilità:

- Per tutta la Serie EVA
- 3001005 Termostatico Doccia esterno
- 1431024 Termostatico quadrato

codice	∅	UM	min. ord.	conf.	cat.	prezzo (€)
● 3101032	1/2"	NR	1	50	09	

VITONE TRADIZIONALE / EVA



Compatibilità:

- Per tutta la Serie TRADIZIONALE e per serie EVA (non ceramico)

codice	∅	UM	min. ord.	conf.	cat.	prezzo (€)
● 3101031	1/2"	NR	1	10	09	

GROHE VITONE



codice	∅	UM	min. ord.	conf.	cat.	prezzo (€)
● 07146000	1/2"	NR	1	1	10	

GROHE VITONE

Per rubinetto ad incasso



codice	∅	UM	min. ord.	conf.	cat.	prezzo (€)
● 07147000	1/2"	NR	1	1	10	

GROHE TESTINA DISCHI CERAMICI



codice	∅	UM	min. ord.	conf.	cat.	prezzo (€)
● 45346000	1/2"	NR	1	1	10	

GROHE VITONE DISCHI CERAMICI



codice	∅	UM	min. ord.	conf.	cat.	prezzo (€)
● 45869000	1/2"	NR	1	1	10	

RICAMBI RUBINETTERIA CROMATA

CARTUCCE E VITONI

CARTUCCIA PER DEVIATORE



Compatibilità:
1350902 Colonna multifunzione IRIDE

codice	Ø	UM	min. ord.	conf.	cat.	prezzo (€)
● 1413084	mm 32	NR	1	1	09	

CARTUCCIA PER RUBINETTO



Compatibilità:
Per tutte le colonne multifunzione

codice	Ø	UM	min. ord.	conf.	cat.	prezzo (€)
● 1413085	mm 40	NR	1	1	09	

CARTUCCIA PER DEVIATORE



Compatibilità:
1350903 Colonna multifunzione SELENE BIANCA
1350912 Colonna multifunzione SELENE NERA
1350913 Colonna multifunzione AURORA

codice	Ø	UM	min. ord.	conf.	cat.	prezzo (€)
● 1413086	mm 35	NR	1	1	09	

CARTUCCIA PER DEVIATORE



Compatibilità:
1350907 Colonna multifunzione FLORA
1350917 Colonna multifunzione DIANA

codice	Ø	UM	min. ord.	conf.	cat.	prezzo (€)
● 1413091	mm 35	NR	1	1	09	

CARTUCCIA PER DEVIATORE



Compatibilità:
1350908 Colonna multifunzione ATENA

codice	Ø	UM	min. ord.	conf.	cat.	prezzo (€)
● 1413089	mm 33	NR	1	1	09	

CARTUCCIA PER DEVIATORE



Compatibilità:
1414009 Deviatore colonna

codice	Ø	UM	min. ord.	conf.	cat.	prezzo (€)
● 1406030	mm 22	NR	1	1	09	

CARTUCCE E VITONI PER TERMOSTATICO

CARTUCCIA PER TERMOSTATICO INCASSO TONDO

Compatibilità:

3012001 Termostatico 1 via
3012002 Termostatico 2 vie
3012003 Termostatico 3 vie
3012004 Termostatico 4 vie



codice	∅	UM	min. ord.	conf.	cat.	prezzo (€)
● 3101107	mm 34	NR	1	1	06	

CARTUCCIA PER TERMOSTATICO INCASSO QUADRO

Compatibilità:

3013001 Termostatico 1 via
3013002 Termostatico 2 vie
3013003 Termostatico 3 vie



codice	∅	UM	min. ord.	conf.	cat.	prezzo (€)
● 3101108	mm 34	NR	1	1	06	

CARTUCCIA PER TERMOSTATICO

Compatibilità:

3001005 Termostatico doccia esterno



codice	∅	UM	min. ord.	conf.	cat.	prezzo (€)
● 3101061	mm 40	NR	1	1	06	

CARTUCCIA PER TERMOSTATICO

Compatibilità:

1431024 Termostatico quadrato



codice	∅	UM	min. ord.	conf.	cat.	prezzo (€)
● 3101117	mm 40	NR	1	1	06	

CARTUCCIA PER TERMOSTATICO

Compatibilità:

1431021 Termostatico esterno



codice	∅	UM	min. ord.	conf.	cat.	prezzo (€)
● 3101088	mm 40	NR	1	1	06	

CARTUCCIA PER TERMOSTATICO

Compatibilità:

1431021 Termostatico esterno



codice	∅	UM	min. ord.	conf.	cat.	prezzo (€)
● 3101089	mm 35	NR	1	1	06	

CARTUCCIA PER TERMOSTATICO

Compatibilità:

1431016 Termostatico tondo



codice	∅	UM	min. ord.	conf.	cat.	prezzo (€)
● 3101122	mm 31	NR	1	1	09	

CARTUCCIA PER TERMOSTATICO

Compatibilità:

1431016 Termostatico tondo (solo cromo)
1431018 Termostatico tondo (solo cromo)



codice	∅	UM	min. ord.	conf.	cat.	prezzo (€)
● 3101077	mm 34	NR	1	1	06	

GROHE TERMEOLEMENTO



codice	∅	UM	min. ord.	conf.	cat.	prezzo (€)
● 47450000	1/2"	NR	1	20	10	

RICAMBI RUBINETTERIA CROMATA

RICAMBI

DADO MANIGLIA



Compatibilità:

- 3001010 Lavabo
- 3001011 Lavabo alto
- 3001012 Bidet
- 3001018 Doccia esterno
- 3001017 Vasca con kit doccia

codice	descrizione	UM	min. ord.	conf.	cat.	prezzo (€)
3101102	maniglia di ricambio	NR	1	1	06	

DADO MANIGLIA



Compatibilità:

- 3001013 Lavabo parete
- 3001014 Doccia incasso
- 3001019 Doccia incasso
- 3001015 Doccia incasso con deviatore
- 3001020 Doccia incasso con deviatore
- 3001016 Doccia incasso 3 vie

codice	descrizione	UM	min. ord.	conf.	cat.	prezzo (€)
3101103	maniglia di ricambio	NR	1	1	06	

TONDA MANIGLIA



Compatibilità:

- 3021010 Lavabo
- 3021026 Lavabo
- 3021011 Lavabo alto
- 3021012 Bidet
- 3021027 Bidet
- 3021014 Lavabo parete piastra unica
- 3021017 Doccia incasso c/deviatore 2 vie

codice	descrizione	UM	min. ord.	conf.	cat.	prezzo (€)
3101106	maniglia di ricambio	NR	1	1	06	

TONDA MANIGLIA



Compatibilità:

- 3021020 Doccia esterno

codice	descrizione	UM	min. ord.	conf.	cat.	prezzo (€)
3101104	maniglia di ricambio	NR	1	1	06	

MAYA MANIGLIA



Compatibilità:

- 3008001 Lavabo
- 3008010 Lavabo "Big Size"
- 3008002 Lavabo corpo alto
- 3008003 Bidet

codice	descrizione	UM	min. ord.	conf.	cat.	prezzo (€)
3008903	maniglia di ricambio	NR	1	1	02	

MAYA MANIGLIA STANDARD



Compatibilità:

- 3008011 Lavabo
- 3008009 Lavabo "Big Size"
- 3008012 Bidet
- 3008006 Doccia incasso con deviatore
- 3008004 Doccia incasso
- 3008005 Doccia esterno
- 3008007 Vasca con kit doccia
- 3008032 Lavello collo cigno

- 3008033 Lavello bocca girevole
- 3008034 Lavello con doccetta

codice	descrizione	UM	min. ord.	conf.	cat.	prezzo (€)
3008913	maniglia di ricambio	NR	1	1	02	

ZERO/MAYA LEVA CLINICA



Compatibilità:

- 3008802 Lavabo leva clinica

codice	descrizione	UM	min. ord.	conf.	cat.	prezzo (€)
3008901	leva clinica di ricambio	NR	1	1	02	

NEMO LEVA CLINICA



Compatibilità:

- 3003019 Lavabo leva clinica

codice	descrizione	UM	min. ord.	conf.	cat.	prezzo (€)
3101070	per cartuccia 35 mm	NR	1	1	02	

DELFINO UNO MANIGLIA



codice	descrizione	UM	min. ord.	conf.	cat.	prezzo (€)
3101001	maniglia di ricambio	NR	1	10	02	

DELFINO UNO / DELFINO DUE LEVA CLINICA



Compatibilità:

- 3002014 Lavello leva clinica
- 3002013 Lavello parete leva clinica
- 3004009 Lavabo leva clinica

codice	descrizione	UM	min. ord.	conf.	cat.	prezzo (€)
3101004	per cartuccia 40 mm	NR	1	1	02	

NEMO MANIGLIA



Compatibilità:
Per tutta la serie NEMO escluso:
3003019 Lavabo leva clinica

codice	descrizione	UM	min. ord.	conf.	cat.	prezzo (€)
● 3101075	maniglia di ricambio	NR	1	1	02	

DELFINO DUE MANIGLIA



Compatibilità:
Per tutta la serie DELFINO DUE escluso:
3004009 Lavabo leva clinica
3006001 Lavabo bocca estraibile

codice	descrizione	UM	min. ord.	conf.	cat.	prezzo (€)
● 3101064	maniglia di ricambio	NR	1	10	02	

EVA MANIGLIA



Compatibilità:
Per tutta la serie EVA

codice	descrizione	UM	min. ord.	conf.	cat.	prezzo (€)
● 3101057	maniglia di ricambio	NR	2	2	02	

TRADIZIONALE MANIGLIA



Compatibilità:
Per tutta la serie TRADIZIONALE

codice	descrizione	UM	min. ord.	conf.	cat.	prezzo (€)
● 3101054	maniglia di ricambio	NR	2	2	02	

MANIGLIA LAVELLO SOTTOFINESTRA



Compatibilità:
1434001 Lavello sottofinestra

codice	descrizione	UM	min. ord.	conf.	cat.	prezzo (€)
● 3101116	ricambio	NR	1	1	02	

MANIGLIA



Compatibilità:
3006001 Lavabo bocca estraibile
1434007 Lavello bocca estraibile

codice	descrizione	UM	min. ord.	conf.	cat.	prezzo (€)
● 3101114	ricambio	NR	1	1	02	

GIULIO MANIGLIA



Compatibilità:
3001000 Lavabo 3 acque

codice	descrizione	UM	min. ord.	conf.	cat.	prezzo (€)
● 3101115	ricambio	NR	1	1	02	

ELIO MANIGLIA



Compatibilità:
3008850 Lavello piega tonda

codice	descrizione	UM	min. ord.	conf.	cat.	prezzo (€)
● 3008922	ricambio	NR	1	1	02	

GROHE BLUE FILTRO BWT



codice	capacità media	UM	min. ord.	conf.	cat.	prezzo (€)
● 40404001	600 lt	NR	1	32	13	
● 40430001	1.500 lt	NR	1	24	13	

CARTUCCIA PER KIT DELO' PUR



codice	capacità media	UM	min. ord.	conf.	cat.	prezzo (€)
● 2006098	15.000 lt	NR	1	6	03	

RICAMBI RUBINETTERIA CROMATA

RICAMBI

MAYA/ZERO PROLUNGA



Compatibilità:

per incassi doccia con deviatore
3008006 Doccia incasso con deviatore
3008805 Doccia incasso con deviatore

codice	lunghezza	UM	min. ord.	conf.	cat.	prezzo (€)
● 3008918	cm.3,5	NR	1	1	02	

DELFINO DUE PROLUNGA



Compatibilità:

per incassi doccia senza deviatore
3004003 Doccia incasso

codice	lunghezza	UM	min. ord.	conf.	cat.	prezzo (€)
● 3101020	cm. 3	NR	1	1	02	

DADO/TONDA PROLUNGA DOCCIA INCASSO 2 VIE A PULSANTE



Compatibilità:

per incassi doccia con deviatore a pulsante
3001015 Doccia incasso con deviatore
3021016 Doccia incasso con deviatore

codice	lunghezza	UM	min. ord.	conf.	cat.	prezzo (€)
● 3101124	cm. 3,75	NR	1	1	02	

NEMO PLACCA PER DOCCIA INCASSO SENZA DEVIATORE



Compatibilità:

3003014 Doccia

codice	descrizione	UM	min. ord.	conf.	cat.	prezzo (€)
● 3101081	placca per doccia	NR	1	1	02	

MAYA DOCCETTA PER LAVELLO CUCINA



Compatibilità:

3008034 Lavello con doccetta

codice	lunghezza	UM	min. ord.	conf.	cat.	prezzo (€)
● 3008911	cm. 10	NR	1	1	02	

MAYA/ZERO PROLUNGA



Compatibilità:

per incassi doccia senza deviatore
3008004 Doccia incasso
3008804 Doccia incasso

codice	lunghezza	UM	min. ord.	conf.	cat.	prezzo (€)
● 3008919	cm.3,5	NR	1	1	02	

DADO/TONDA PROLUNGA DOCCIA INCASSO 1 VIA A PULSANTE



Compatibilità:

per incassi doccia senza deviatore
3001014 Doccia incasso
3021015 Doccia incasso

codice	lunghezza	UM	min. ord.	conf.	cat.	prezzo (€)
● 3101123	cm. 3,75	NR	1	1	02	

DELFINO DUE PLACCA DOCCIA INCASSO SENZA DEVIATORE



Compatibilità:

3004003 Doccia

codice	descrizione	UM	min. ord.	conf.	cat.	prezzo (€)
● 3101065	placca di ricambio	NR	1	1	02	

MAYA DEVIATORE DOCCIA INCASSO



Compatibilità:

3008006 Doccia incasso con deviatore.

codice	descrizione	UM	min. ord.	conf.	cat.	prezzo (€)
● 3008910	deviatore di ricambio	NR	1	1	02	

DOCCETTA A CAMPANA

In ottone

PORTATA litri/minuto: 25



Compatibilità:

3007009 Vasca

codice	sez. (mm)	lung. (mm)	UM	min. ord.	conf.	cat.	prezzo (€)
● 1412003	Ø 52	184	NR	1	1	06	

DOCCETTA PER LAVELLO CUCINA



Compatibilità:

1434007 Lavello con doccetta

codice	lunghezza	UM	min. ord.	conf.	cat.	prezzo (€)
● 1413028	cm. 17	NR	1	100	02	

CONFEZIONE FISSAGGI LAVELLO CUCINA



codice	descrizione	UM	min. ord.	conf.	cat.	prezzo (€)
● 3101015	fissaggi	NR	1	20	02	

CONFEZIONE FISSAGGI LAVABO/BIDET



codice	UM	min. ord.	conf.	cat.	prezzo (€)
● 3101014	NR	1	20	02	

FLESSIBILE PER DOCCETTA ESTRAIBILE

F 1/2" x M15



Compatibilità:

3006001 Lavabo bocca estraibile

1434007 Lavello doccia estraibile

codice	lunghezza	UM	min. ord.	conf.	cat.	prezzo (€)
● 3101111	cm. 125	NR	1	1	02	

FLESSIBILE PVC PER DOCCETTA ESTRAIBILE

F 1/2" x M15



codice	lunghezza	UM	min. ord.	conf.	cat.	prezzo (€)
● 3101018	cm. 120	NR	1	10	02	

FLESSIBILE PER LAVELLO CUCINA

F 1/2" x M15



codice	lunghezza	UM	min. ord.	conf.	cat.	prezzo (€)
● 1413029	cm. 150	NR	1	50	09	
● 1413069	cm. 200	NR	1	50	09	

GROHE FLESSIBILE DI RACCORDO 420mm 3/8"



codice	UM	min. ord.	conf.	cat.	prezzo (€)
● 48066000	NR	1	1	10	

GROHE FLESSIBILE PER MISCELATORI LAVELLO

F 1/2" x M15



NOVITÀ!

codice	lunghezza	UM	min. ord.	conf.	cat.	prezzo (€)
● 46092000	ricambio	NR	1	1	10	

DELFINO DUE BOCCA ESTRAIBILE PER LAVABO



Compatibilità:

3006001 Lavabo bocca estraibile

codice	descrizione	UM	min. ord.	conf.	cat.	prezzo (€)
● 3101096	ricambio	NR	1	1	02	

BOCCA



Compatibilità:

3004008 Lavello parete

codice	lunghezza (mm)	UM	min. ord.	conf.	cat.	prezzo (€)
● 3101038	200	NR	1	10	02	
● 3101066	300	NR	1	10	02	

TONDA BOCCA EROGAZIONE



NOVITÀ!

Compatibilità:

3021025 Lavello collo cigno

codice	descrizione	UM	min. ord.	conf.	cat.	prezzo (€)
● 3101138	ricambio	NR	1	1	02	

RICAMBI RUBINETTERIA CROMATA

RICAMBI

DELFINO DUE BOCCA EROGAZIONE



Compatibilità:
3004010 Lavello dal 2018

codice	descrizione	UM	min. ord.	conf.	cat.	prezzo (€)
● 3101090	ricambio	NR	1	5	02	

EVA BOCCA EROGAZIONE



Compatibilità:
3007018 Lavello

codice	descrizione	UM	min. ord.	conf.	cat.	prezzo (€)
● 3101084	ricambio	NR	1	1	02	

AMEDEO BOCCA EROGAZIONE



Compatibilità:
3005050 Lavello

codice	descrizione	UM	min. ord.	conf.	cat.	prezzo (€)
● 3101110	nera / cromo	NR	1	1	02	

AMEDEO BOCCA EROGAZIONE



Compatibilità:
3005051 Lavello

codice	descrizione	UM	min. ord.	conf.	cat.	prezzo (€)
● 3101109	bianca / cromo	NR	1	1	02	

BOCCE DI EROGAZIONE

BOCCA "U" UNIVERSALE CON AERATORE

Canna D. 18 mm,
attacco 3/4"



codice	sigla	lunghezza (mm)	UM	min. ord.	conf.	cat.	prezzo (€)
● 2670001	3024.201.3.	200	NR	1	10	06	
● 2670002	3024.251.3.	250	NR	1	10	06	
● 2670003	3024.301.3.	300	NR	1	5	06	

BOCCA "J" UNIVERSALE CON AERATORE

Canna D. 18 mm,
attacco 3/4"



codice	sigla	lung. (mm)	H (cm)	UM	min. ord.	conf.	cat.	prezzo (€)
● 2670011	3026.201.3.	200	15	NR	1	10	06	
● 2670012	3026.251.3.	250	20	NR	1	10	06	

BOCCA "S" UNIVERSALE CON AERATORE

Canna D. 18 mm,
attacco 3/4"



codice	sigla	lunghezza (mm)	UM	min. ord.	conf.	cat.	prezzo (€)
● 2670020	3022.151.3.	150	NR	1	10	06	
● 2670021	3022.201.3.	200	NR	1	10	06	
● 2670022	3022.251.3.	250	NR	1	10	06	
● 2670023	3022.301.3.	300	NR	1	5	06	

BOCCA "CIGNO" UNIVERSALE CON AERATORE

Canna D. 18 mm,
attacco 3/4"



codice	lunghezza (mm)	H (cm)	UM	min. ord. conf.	cat.	prezzo (€)
● 2670031	200	14	NR	1	06	

AERATORI

AERATORE HONEYCOMB MASCHIO

Filtro in plastica



codice	sigla	Ø	portata (lt/min)	UM	min. ord. conf.	cat.	prezzo (€)
● 2751001	01403195	M 24x1	7,5 - 9	NR	10	09	

AERATORE HONEYCOMB FEMMINA

Filtro in plastica



codice	sigla	Ø	portata (lt/min)	UM	min. ord. conf.	cat.	prezzo (€)
● 2751002	01403095	M 22x1	7,5 - 9	NR	10	09	

AERATORE HONEYCOMB MASCHIO

Filtro in plastica



codice	sigla	Ø	portata (lt/min)	UM	min. ord. conf.	cat.	prezzo (€)
● 2751017	01401795	M 28x1	27 - 30	NR	5	09	

AERATORE CASCADE MASCHIO

Protezione anticalcare superiore, rumorosità estremamente ridotta, antisciacchiamento



codice	sigla	Ø	portata (lt/min)	UM	min. ord. conf.	cat.	prezzo (€)
● 2751020	01030094	M 24x1	13,5 - 15	NR	10	09	

AERATORE CASCADE FEMMINA

Protezione anticalcare superiore, rumorosità estremamente ridotta, antisciacchiamento



codice	sigla	Ø	portata (lt/min)	UM	min. ord. conf.	cat.	prezzo (€)
● 2751021	01010094	M 22x1	13,5 - 15	NR	10	09	

AERATORE CASCADE MASCHIO

Protezione anticalcare superiore, rumorosità estremamente ridotta, antisciacchiamento



codice	sigla	Ø	portata (lt/min)	UM	min. ord. conf.	cat.	prezzo (€)
● 2751022	01040094	M 28x1	27 - 30	NR	5	09	

AERATORE DE LUX MASCHIO

Filtro in plastica. Getto morbido e ventilato.



codice	sigla	Ø	portata (lt/min)	UM	min. ord. conf.	cat.	prezzo (€)
● 2751030	40460495	M 24x1	13,5 - 15	NR	10	09	

AERATORE DE LUX FEMMINA

Filtro in plastica. Getto morbido e ventilato.



codice	sigla	Ø	portata (lt/min)	UM	min. ord. conf.	cat.	prezzo (€)
● 2751031	40460395	M 22x1	13,5 - 15	NR	10	09	

AERATORE DE LUX MASCHIO

Filtro in plastica. Getto morbido e ventilato.



codice	sigla	Ø	portata (lt/min)	UM	min. ord. conf.	cat.	prezzo (€)
● 2751032	40460695	M 28x1	27 - 30	NR	5	09	

CACHE' HONEYCOMB MASCHIO



codice	sigla	Ø	portata (lt/min)	UM	min. ord. conf.	cat.	prezzo (€)
● 2751200	01515190	M 16,5x1	totale	NR	1	09	

RICAMBI RUBINETTERIA CROMATA

AERATORI

CACHE' HONEYCOMB MASCHIO

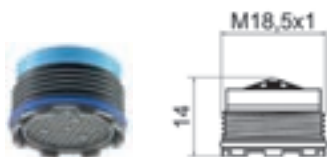

codice	sigla	Ø	portata (lt/min)	UM	min. ord. conf.	cat.	prezzo (€)
● 2751201	01515590	M 18,5x1	13,5-15	NR	1	09	

CACHE' HONEYCOMB MASCHIO



codice	sigla	Ø	portata (lt/min)	UM	min. ord. conf.	cat.	prezzo (€)
● 2751202	01510190	M 21,5x1	13,5-15	NR	1	09	

MAYA/ZERO CACHE' COIN SLOT



Compatibilità:
3008003 Bidet
3008012 Bidet
3008803 Bidet

codice	Ø	UM	min. ord. conf.	cat.	prezzo (€)
● 2751204	M 16,5x1	NR	10	09	

GIULIO CACHE'

Senza parte cromata



Compatibilità:
3001000 Lavello 3 acque

codice	descrizione	UM	min. ord. conf.	cat.	prezzo (€)
● 3101120	ricambio	NR	1	09	

CACHE' SLIM MASCHIO



codice	Ø	Portata (lt/min)	UM	min. ord. conf.	cat.	prezzo (€)
● 2751061	M 24x1	13,5-15	NR	1	09	

CACHE COIN SLOT MASCHIO

Fessura che permette di avvitare e svitare con una moneta. Utilizzabile senza guscio in ottone. Compatibile con aeratori M24x1 esistenti



codice	sigla	Ø	Portata (lt/min)	UM	min. ord. conf.	cat.	prezzo (€)
● 2751060	45302894	M 24x1	13,5-15	NR	10	09	

AERATORE A SNODO MASCHIO



codice	sigla	Ø	UM	min. ord. conf.	cat.	prezzo (€)
● 2750450	01040001CR	M 24x1	NR	10	09	

AERATORE A SNODO FEMMINA

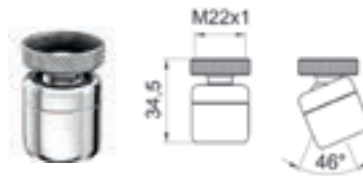

codice	sigla	Ø	UM	min. ord. conf.	cat.	prezzo (€)
● 2750451	01030001CR	M 22x1	NR	10	09	

AERATORE A SNODO PER INCASSO MASCHIO



codice	sigla	Ø	UM	min. ord. conf.	cat.	prezzo (€)
● 2750452	01050001CR	M 24x1	NR	10	09	

RIDUZIONE PER AERATORI



codice	sigla	Ø foto	UM	min. ord. conf.	cat.	prezzo (€)
● 2750400	06820000CR	M 22x1 - M 24x1	NR	10	09	

AERATORI

RIDUZIONE PER AERATORI

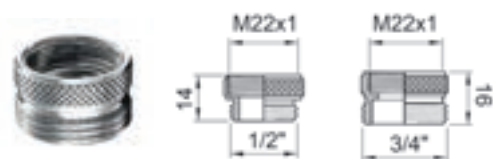

codice	sigla	Ø foto	UM	min. ord. conf.	cat.	prezzo (€)
● 2750410	06810400CR	M 1/2" - F 22x1	NR	10	09	
● 2750411	06810500CR	M 3/4" - F 22x1	NR	10	09	

RIDUZIONE PER AERATORI



codice	sigla	Ø	UM	min. ord. conf.	cat.	prezzo (€)
● 2750401	0681M400CR	M 1/2" - M 24x1	NR	10	09	

CHIAVE UNIVERSALE NICHELATA



codice	sigla	Ø	UM	min. ord. conf.	cat.	prezzo (€)
● 2751305	01458097	M22-M24-M28-M18 cachè 16,5-18,5-21,5	NR	1	09	

CHIAVE UNIVERSALE PLASTICA



codice	sigla	Ø	UM	min. ord. conf.	cat.	prezzo (€)
● 2751307	01455094	M22-M24-M28 cachè 16,5-18,5-21,5	NR	1	09	

CHIAVE DI MONTAGGIO CACHE'



codice	sigla	Ø	colore	UM	min. ord. conf.	cat.	prezzo (€)
● 2751302	09915046	M 16,5x1	GIALLA	NR	1	09	
● 2751303	09915346	M 18,5x1	VERDE	NR	1	09	
● 2751308	09915146	M 21,5x1	ROSSA	NR	1	09	
● 2741304	09915246	M 24x1	GRIGIO	NR	1	09	

KIT WATERSAVING

Composto da:
n. 1 chiave in plastica blu per aeratori M22 - M24 - M28,
n. 3 aeratori maschio M24x1
n. 1 aeratore femmina M22x1
Risparmio idrico 50%



codice	sigla	descrizione	UM	min. ord. conf.	cat.	prezzo (€)
● 2751090	35626200001	kit casa	NR	1	15	09

PILETTE

PILETTA TAPPO SALTERELLO, SENZA COMANDO

Piletta in ottone, tappo in ottone.



RICAMBI (PAG. 173)
2661095 - Tappo

codice	Ø	tappo (mm)	UM	min. ord. conf.	cat.	prezzo (€)
● 2106003	1"1/4x63	40	NR	1	30	01
● 2106002	1"x63 (fuori norma)	40	NR	1	30	01

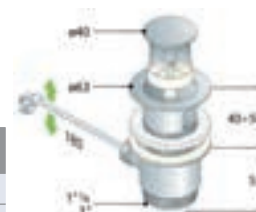

CATALOGO
LISTINO N° 6

LINEA DOCCIA

TERMOSTATICI	72
COLONNE DOCCIA	78
SALISCENDI	90
SOFFIONI DOCCIA	95
BRACCI DOCCIA	100
DOCCETTE	102
SET DOCCIA	105
PRESE ACQUA	106
IDROSCOPINI E KIT DOCCETTA	109
FLESSIBILI DOCCIA	112
RICAMBI	113

LINEA DOCCIA

TERMOSTATICI

TERMOSTATICO INCASSO TONDO 1 VIA

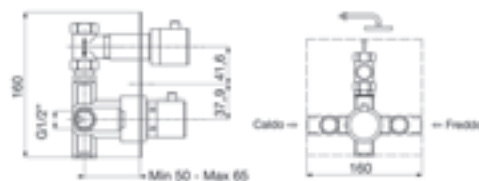

RICAMBI (PAG. 56-69)
3101107 - Maniglia + Cartuccia (solo cromo)

codice	finitura	UM	min. ord.	conf.	cat.	prezzo (€)
● 3012001	cromo	NR	1	10	11	
3012901	nero opaco	NR	1	1	11	

TERMOSTATICO INCASSO TONDO 2 VIE

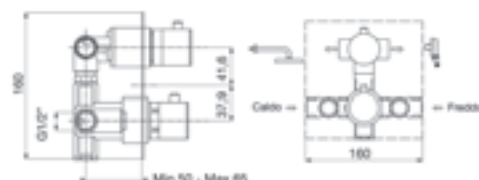

RICAMBI (PAG. 56-69)
3101107 - Maniglia + Cartuccia (solo cromo)

codice	finitura	UM	min. ord.	conf.	cat.	prezzo (€)
● 3012002	cromo	NR	1	10	11	
3012902	nero opaco	NR	1	1	11	

TERMOSTATICO INCASSO TONDO 3 VIE

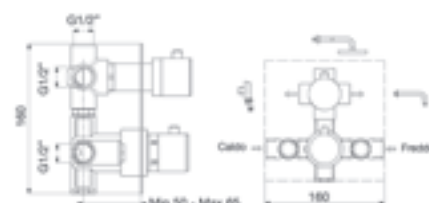

RICAMBI (PAG. 56-69)
3101107 - Maniglia + Cartuccia (solo cromo)

codice	finitura	UM	min. ord.	conf.	cat.	prezzo (€)
● 3012003	cromo	NR	1	10	11	
3012903	nero opaco	NR	1	1	11	

TERMOSTATICO INCASSO QUADRO 1 VIA



RICAMBI (PAG. 56-69)

3101108 - Maniglia + Cartuccia (solo cromo)

	codice	finitura	UM	min. ord.	conf.	cat.	prezzo (€)
●	3013001	cromo	NR	1	10	11	
	3013901	nero opaco	NR	1	1	11	



TERMOSTATICO INCASSO QUADRO 2 VIA



RICAMBI (PAG. 56-69)

3101108 - Maniglia + Cartuccia (solo cromo)

	codice	finitura	UM	min. ord.	conf.	cat.	prezzo (€)
●	3013002	cromo	NR	1	10	11	
	3013902	nero opaco	NR	1	1	11	

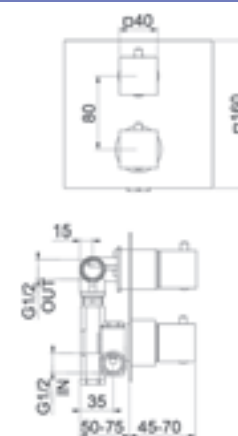

TERMOSTATICO INCASSO QUADRO 3 VIE



RICAMBI (PAG. 56-69)

3101108 - Maniglia + Cartuccia (solo cromo)

	codice	finitura	UM	min. ord.	conf.	cat.	prezzo (€)
●	3013003	cromo	NR	1	10	11	
	3013903	nero opaco	NR	1	1	11	

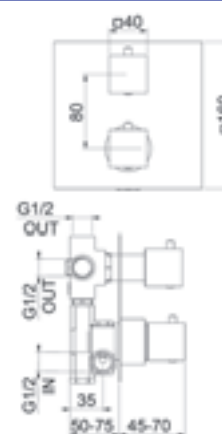

LINEA DOCCIA

GROHE SMARTCONTROL

MISCELATORE TERMOSTATICO A 2 VIE QUADRATO



Solo parti esterne cromate, da completare con il corpo incasso universale Rapido Smartbox (35604000)

codice	UM	min. ord.	conf.	cat.	prezzo (€)
● 29124000	NR	1	3	10	

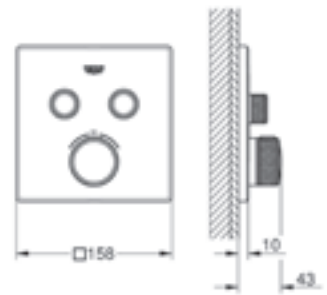

MISCELATORE TERMOSTATICO A 3 VIE QUADRATO



Solo parti esterne cromate, da completare con il corpo incasso universale Rapido Smartbox (35604000)

codice	UM	min. ord.	conf.	cat.	prezzo (€)
● 29126000	NR	1	3	10	

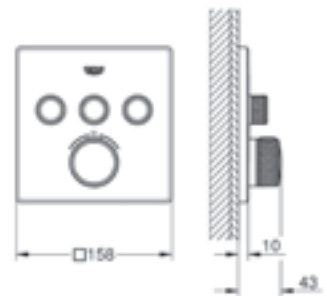

MISCELATORE TERMOSTATICO A 2 VIE TONDO



Solo parti esterne cromate, da completare con il corpo incasso universale Rapido Smartbox (35604000)

codice	UM	min. ord.	conf.	cat.	prezzo (€)
● 29119000	NR	1	3	10	

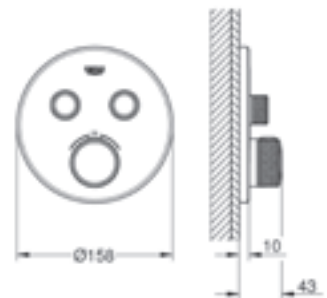

MISCELATORE TERMOSTATICO A 3 VIE TONDO



Solo parti esterne cromate, da completare con il corpo incasso universale Rapido Smartbox (35604000)

codice	UM	min. ord.	conf.	cat.	prezzo (€)
● 29121000	NR	1	3	10	

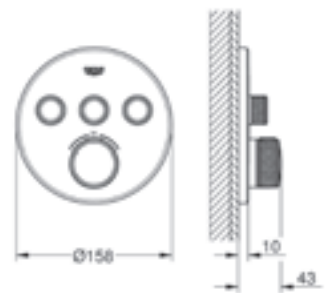

RAPIDO SMARTBOX CORPO INCASSO UNIVERSALE



Per miscelatori Smartcontrol e per tutte le serie ad incasso Grohe.

codice	UM	min. ord.	conf.	cat.	prezzo (€)
● 35604000	NR	1	12	13	

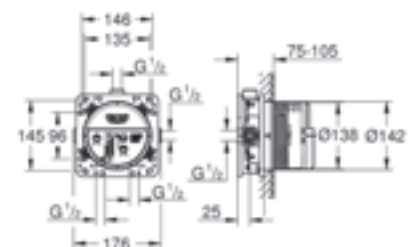

TERMOSTATICO BLISS TONDO "COOL BODY"

Il termostatico "COOL BODY" è in grado di isolare la propria superficie esterna lasciandola fredda, permettendo una maggiore sicurezza contro le scottature.



RICAMBI (PAG. 56-69)

3101077 - Cartuccia termostatica (solo cromo)



codice	finitura	UM	min. ord.	conf.	cat.	prezzo (€)
● 1431018	cromo	NR	1	1	03	
● 1431918	nero opaco	NR	1	1	03	
● 1431818	simil acciaio	NR	1	1	03	

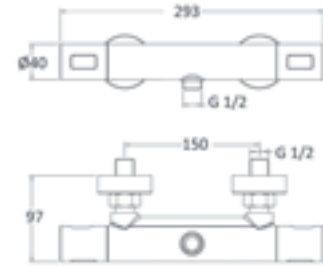

TERMOSTATICO DOCCIA ESTERNO

Attacco da 1/2", maniglie in ABS.



RICAMBI (PAG. 56-69)

3101061 - Cartuccia termostatica

3101032 - Vitone

codice	UM	min. ord.	conf.	cat.	prezzo (€)
● 3001005	NR	1	8	03	

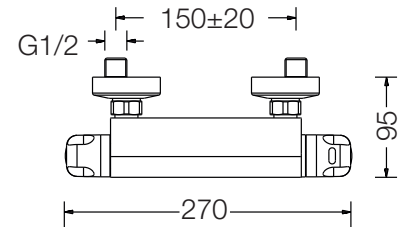

GROHTHERM 800

Attacco da 1/2", maniglie in ABS.



RICAMBI (PAG. 56-69)

45346000 - Testina ceramica

codice	UM	min. ord.	conf.	cat.	prezzo (€)
● 34558000	NR	1	8	17	

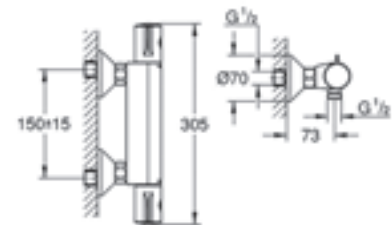

GROHTHERM 1000

Attacco da 1/2", maniglie metalliche.



RICAMBI (PAG. 56-69)

45346000 - Testina ceramica

codice	UM	min. ord.	conf.	cat.	prezzo (€)
● 34827000	NR	1	8	17	

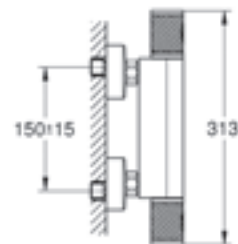
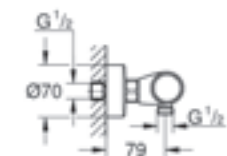

LINEA DOCCIA

TERMOSTATICI PER COLONNA DOCCIA

TERMOSTATICO PER COLONNA DOCCIA 2 USCITE

Attacchi da 1/2" con deviatore incorporato per colonne VIOLA, MAGNOLIA e NARCISO. Maniglie in ABS.



RICAMBI (PAG. 56-69)

- 3101088 - Cartuccia termostatica
- 3101089 - Cartuccia deviatrice

codice	UM	min. ord.	conf.	cat.	prezzo (€)
● 1431021	NR	1	9	03	

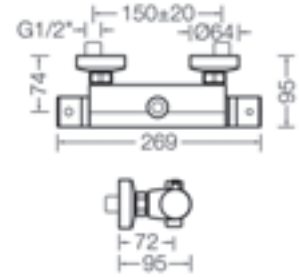

TERMOSTATICO BLISS TONDO PER COLONNA DOCCIA 2 USCITE, "COOL BODY"

Il termostatico "COOL BODY" ha il corpo freddo in grado di isolare la superficie esterna del termostatico lasciandola fredda, permettendo una maggiore sicurezza contro le scottature. Attacchi da 1/2" con deviatore incorporato per colonne VIOLA, MAGNOLIA e NARCISO. Maniglie metalliche.



RICAMBI (PAG. 56-69)

- 3101077 - Cartuccia termostatica (solo cromo)
- 3101122 - Cartuccia deviatrice



codice	finitura	UM	min. ord.	conf.	cat.	prezzo (€)
● 1431016	cromo	NR	1	9	03	
● 1431916	nero opaco	NR	1	1	03	
● 1431816	simil acciaio	NR	1	1	03	

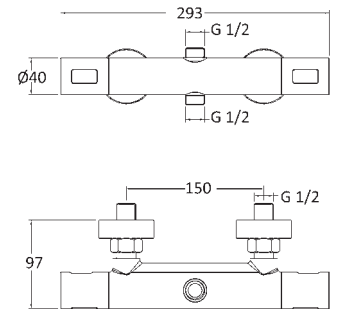

TERMOSTATICO QUADRATO PER COLONNA DOCCIA 2 USCITE

Attacchi da 1/2" con deviatore incorporato per colonne VIOLA, MAGNOLIA e NARCISO. Maniglie in ABS.



RICAMBI (PAG. 56-69)

- 3101117 - Cartuccia termostatica
- 3101032 - Vitone

codice	UM	min. ord.	conf.	cat.	prezzo (€)
● 1431024	NR	1	10	03	

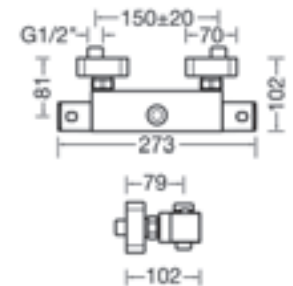

DOCCIA ESTERNO PER COLONNA DOCCIA 2 USCITE, "COOL BODY"

Il miscelatore "COOL BODY" è in grado di isolare la propria superficie esterna lasciandola fredda, permettendo una maggiore sicurezza contro le scottature.

Attacchi da 1/2" con deviatore incorporato per colonne VIOLA, MAGNOLIA e NARCISO. Maniglie metalliche.



RICAMBI (PAG. 56-69)
3101074 - Cartuccia



codice	finitura	UM	min. ord.	conf.	cat.	prezzo (€)
● 1431015	cromo	NR	1	9	03	
● 1431915	nero opaco	NR	1	1	03	
1431815	simil acciaio	NR	1	1	03	

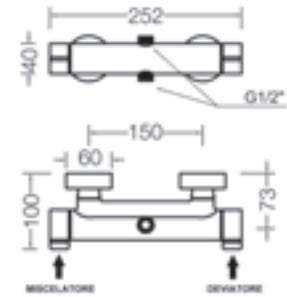

DOCCIA ESTERNO PER COLONNA DOCCIA 1 USCITA

Reversibile: l'attacco da 1/2" può essere posizionato sia nella parte superiore sia nella parte inferiore, girando il miscelatore. Maniglia metallica.



RICAMBI (PAG. 56-69)
3101042 - Cartuccia

codice	UM	min. ord.	conf.	cat.	prezzo (€)
● 1430007	NR	1	1	03	

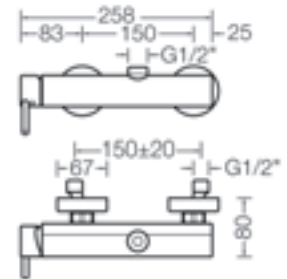

DEVIATORI

DEVIATORE INCASSO 2 VIE

Incluso corpo incasso



RICAMBI (PAG. 56-69)
3101072 - Cartuccia

codice	UM	min. ord.	conf.	cat.	prezzo (€)
● 1431014	NR	1	1	03	

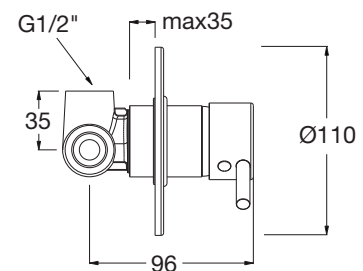

DEVIATORE INCASSO 3 VIE

Incluso corpo incasso



RICAMBI (PAG. 56-69)
3101072 - Cartuccia

codice	UM	min. ord.	conf.	cat.	prezzo (€)
● 1431017	NR	1	1	03	

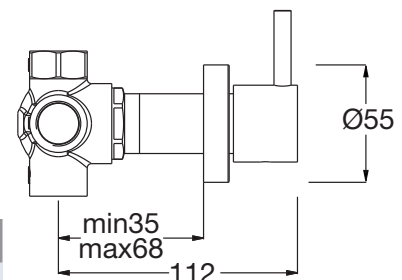

LINEA DOCCIA

COLONNE DOCCIA MULTIFUNZIONE

SELENE COLONNA DOCCIA MULTIFUNZIONE ALLUMINIO NERO OPACO

Colonna in alluminio (colore nero opaco) multifunzione anticalcare con miscelatore e **getto a cascata**. Senza copertura superiore. Portata 10 litri/min a 2 bar.

LINEA
DOCCIA

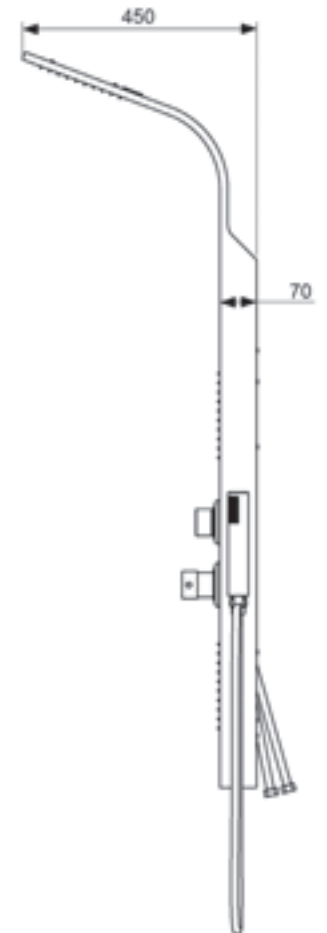
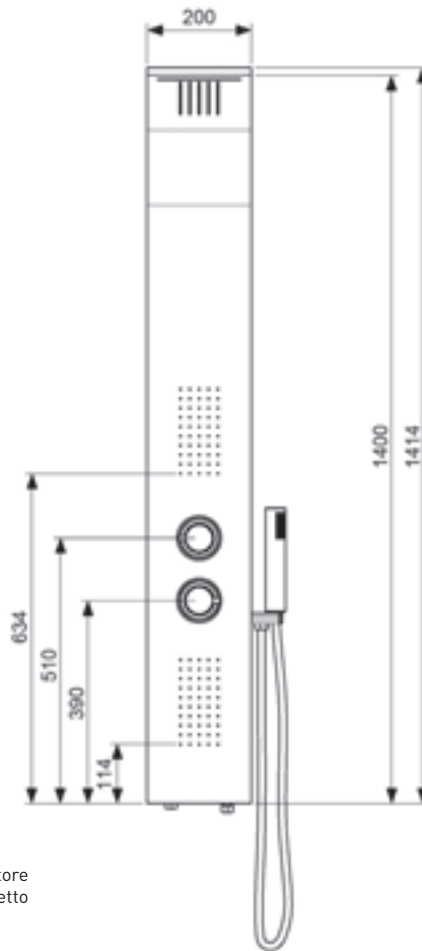

RICAMBI (PAG. 56-69)
1413086 - Cartuccia deviatore
1413085 - Cartuccia rubinetto

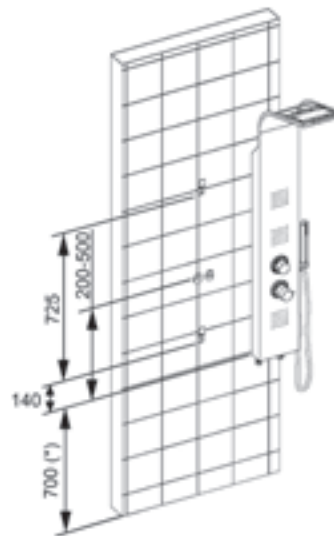
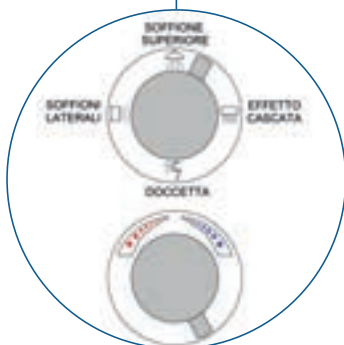

(*) Altezza consigliata da terra

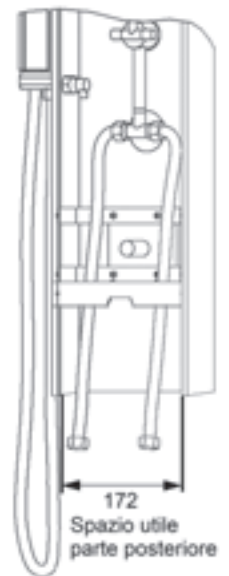

codice	UM	min. ord. conf.	cat.	prezzo (€)
● 1350912	NR	1	05	

SELENE COLONNA DOCCIA MULTIFUNZIONE ALLUMINIO BIANCO OPACO

Colonna in alluminio (colore bianco opaco) multifunzione anticalcare con miscelatore e **getto a cascata**. Senza copertura superiore. Portata 10 litri/min a 2 bar.

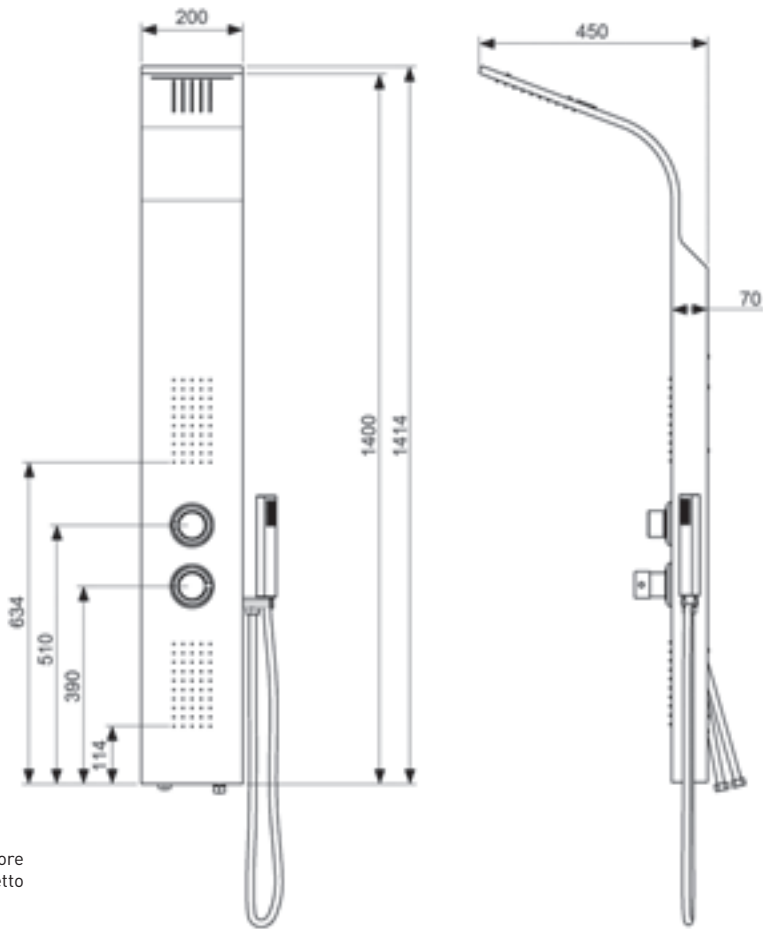

RICAMBI (PAG. 56-69)
1413086 - Cartuccia deviatore
1413085 - Cartuccia rubinetto

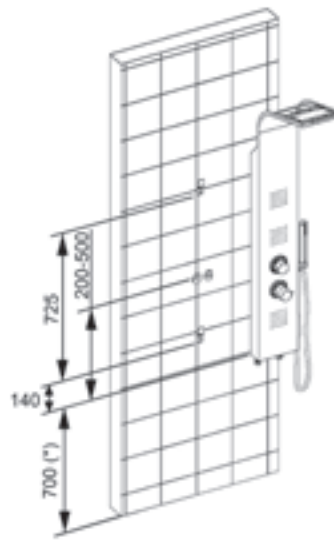
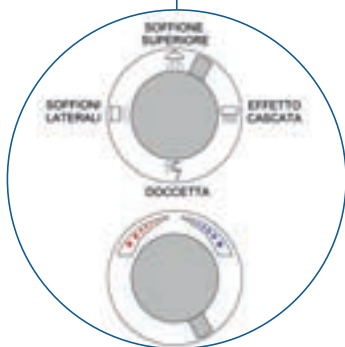

(*) Altezza consigliata da terra

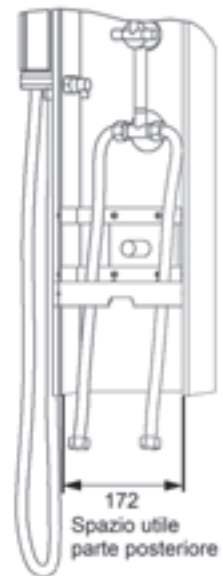

codice	UM	min. ord. conf.	cat.	prezzo (€)
● 1350903	NR	1	05	

LINEA DOCCIA

COLONNE DOCCIA MULTIFUNZIONE

AURORA COLONNA DOCCIA MULTIFUNZIONE ACCIAIO LUCIDO

Colonna in acciaio lucido multifunzione anticalcare con miscelatore e **getto a cascata**. Senza copertura superiore. Portata 10 litri/min a 2 bar.

LINEA
DOCCIA

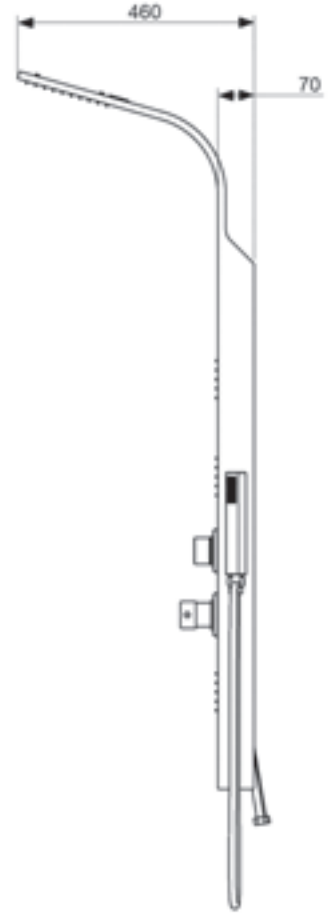
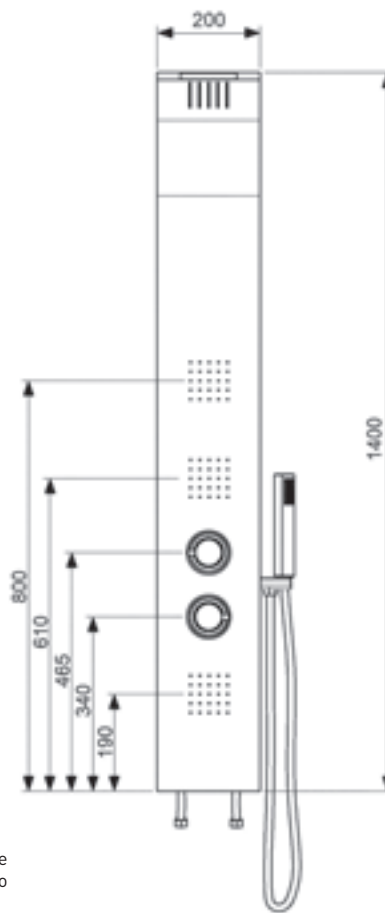

RICAMBI (PAG. 56-69)
1413086 - Cartuccia deviatore
1413085 - Cartuccia rubinetto

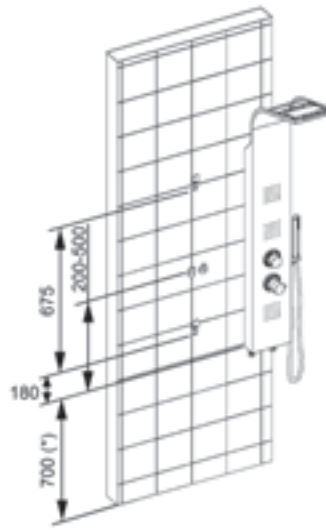
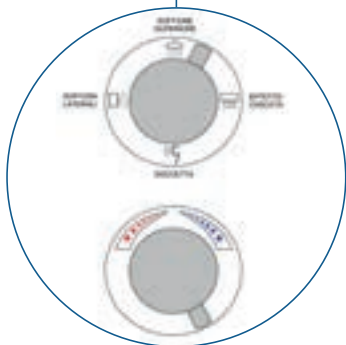

(*) Altezza consigliata da terra

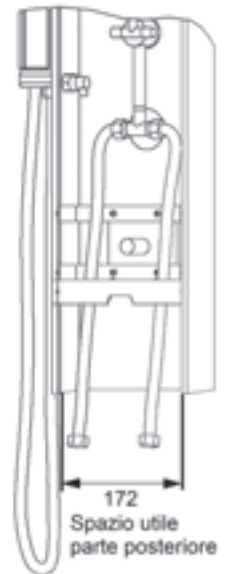

codice	UM	min. ord. conf.	cat.	prezzo (€)
● 1350913	NR	1	05	

IRIDE COLONNA DOCCIA MULTIFUNZIONE ACCIAIO LUCIDO

Colonna in acciaio lucido multifunzione anticalcare con miscelatore. Senza copertura superiore. Portata 10 litri/min a 2 bar.

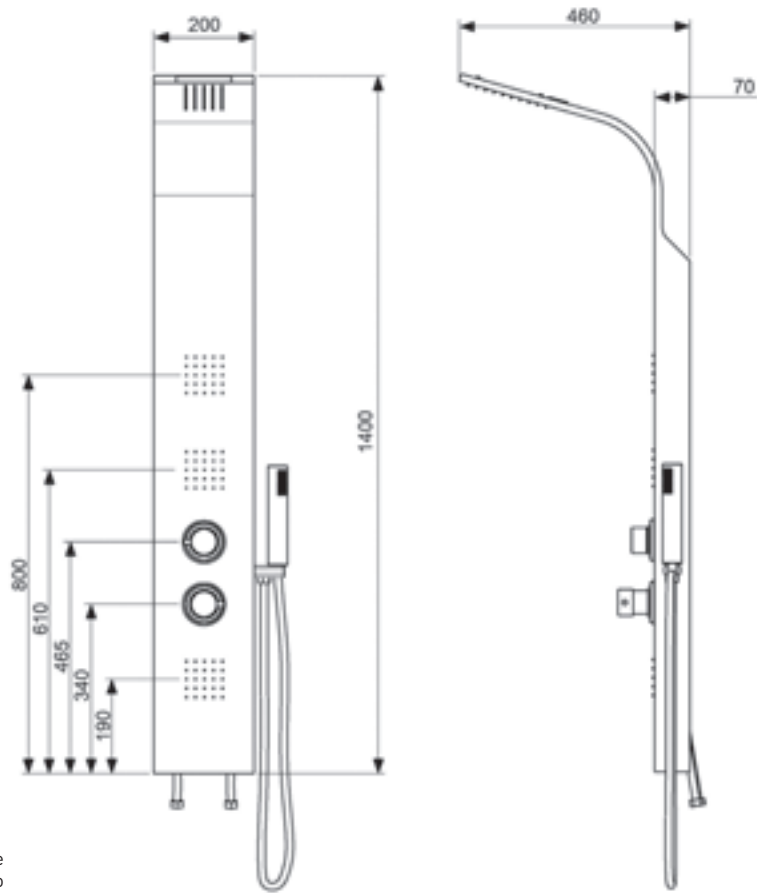

RICAMBI (PAG. 56-69)
1413084 - Cartuccia deviatore
1413085 - Cartuccia rubinetto

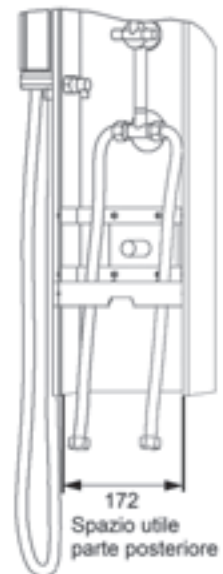
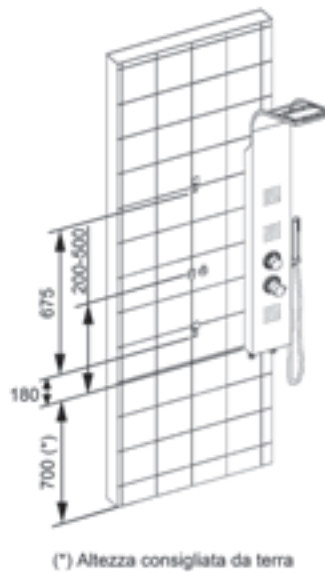
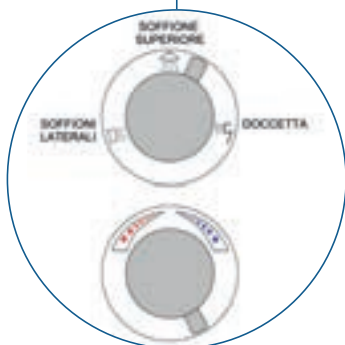

codice	UM	min. ord. conf.	cat.	prezzo (€)
● 1350902	NR	1	05	

LINEA DOCCIA

COLONNE DOCCIA MULTIFUNZIONE

MINERVA COLONNA DOCCIA MULTIFUNZIONE ACCIAIO LUCIDO

Colonna in acciaio lucido multifunzione anticalcare con miscelatore, senza soffioni laterali. Senza copertura superiore
 Portata 10 litri/min. a 2 bar.

LINEA
DOCCIA

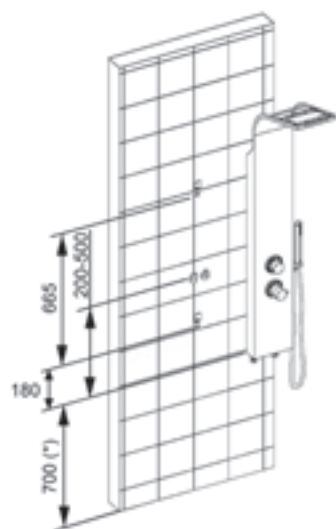
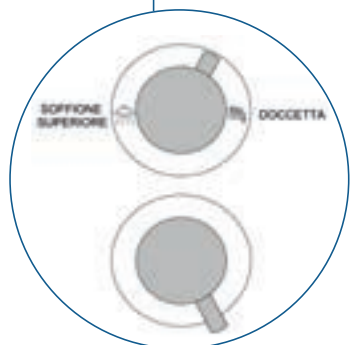
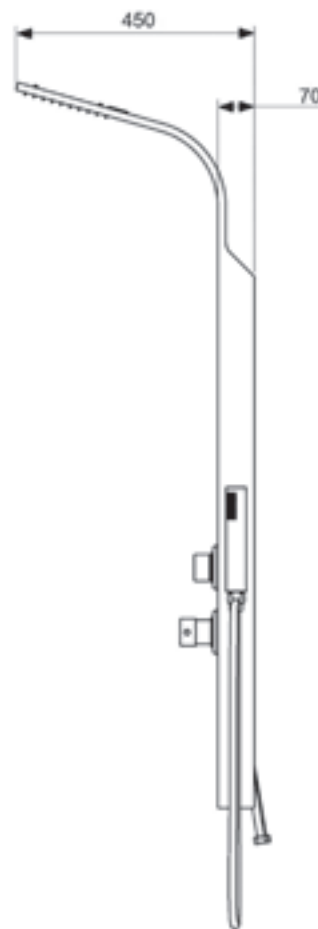
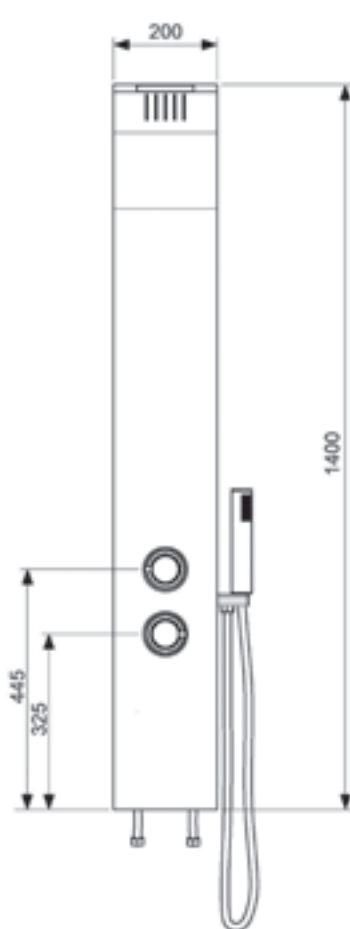

(*) Altezza consigliata da terra

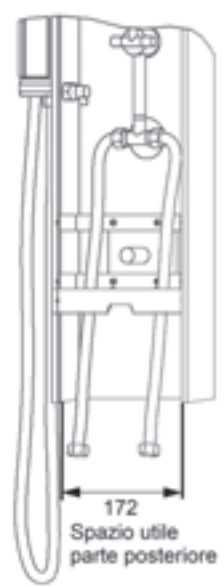

codice	UM	min. ord. conf.	cat.	prezzo (€)
● 1350918	NR	1	05	

DIANA COLONNA DOCCIA MULTIFUNZIONE ALLUMINIO NERO OPACO

Colonna in alluminio (colore nero opaco) multifunzione anticalcare con miscelatore e **getto a cascata**. Senza copertura superiore. Portata 10 litri/min a 2 bar.

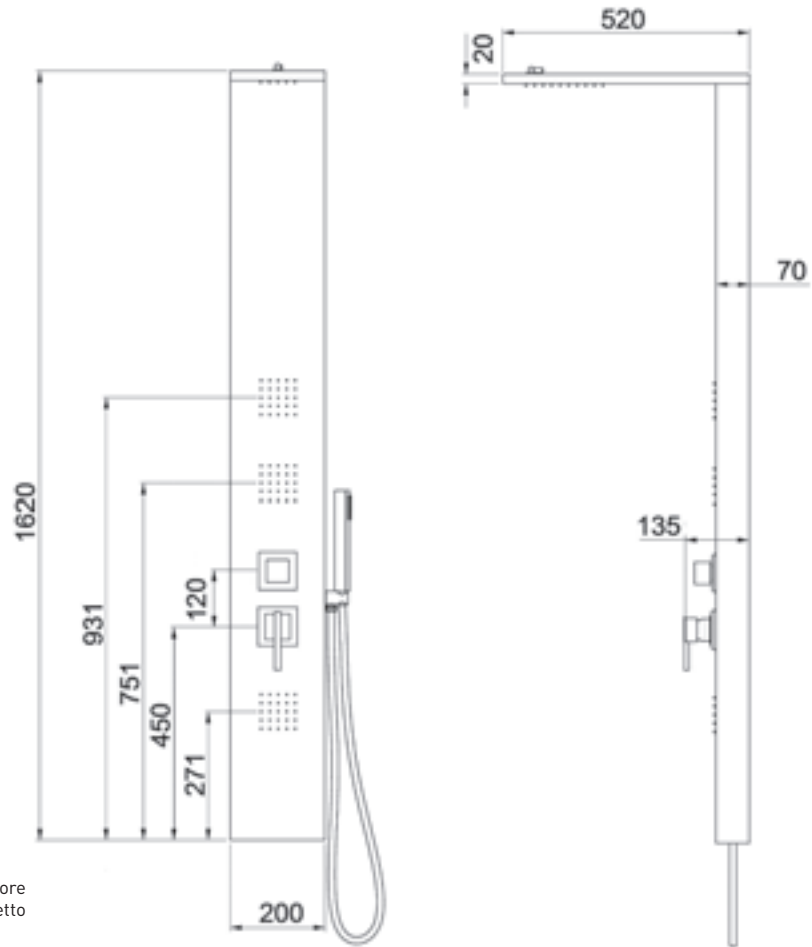

RICAMBI (PAG. 56-69)
 1413091 - Cartuccia deviatore
 1413085 - Cartuccia rubinetto

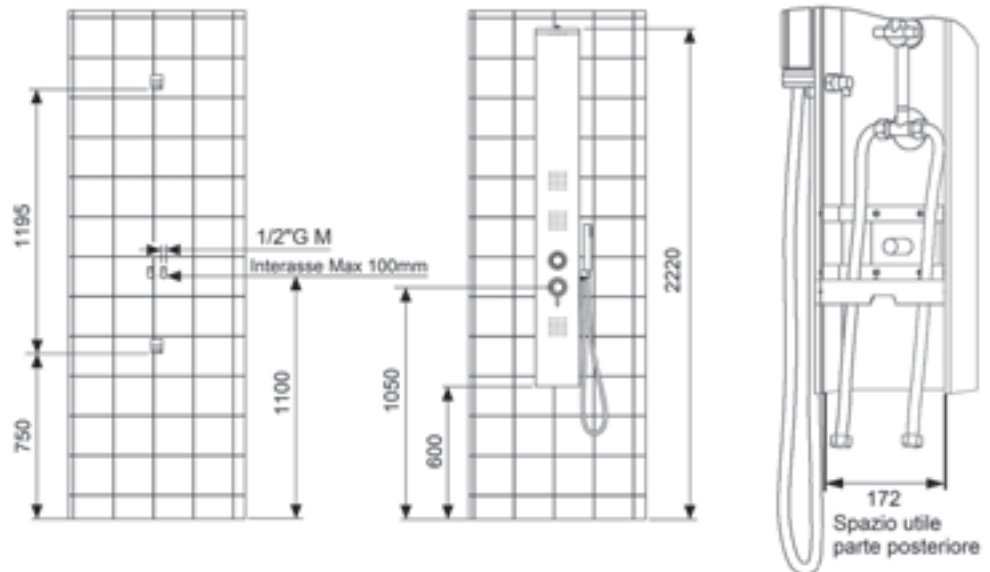
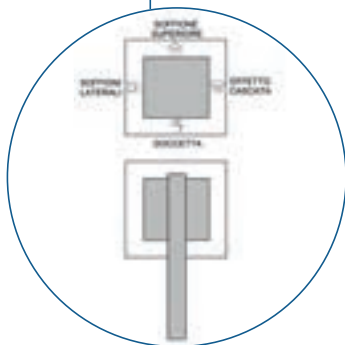

codice	UM	min. ord. conf.	cat.	prezzo (€)
● 1350917	NR	1	05	

LINEA DOCCIA

COLONNE DOCCIA MULTIFUNZIONE

FLORA COLONNA DOCCIA MULTIFUNZIONE ACCIAIO LUCIDO

Colonna in acciaio lucido multifunzione anticalcare con miscelatore e **getto a cascata**. Senza copertura superiore. Portata 10 litri/min a 2 bar.

LINEA
DOCCIA

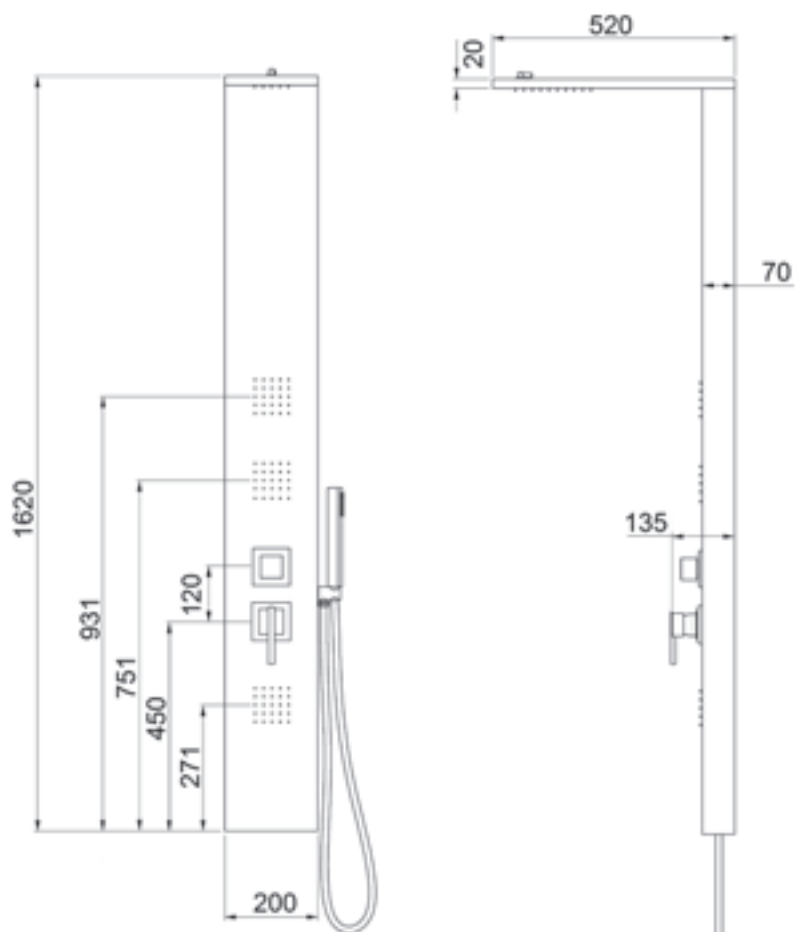

RICAMBI (PAG. 56-69)
1413091 - Cartuccia deviatore
1413085 - Cartuccia rubinetto

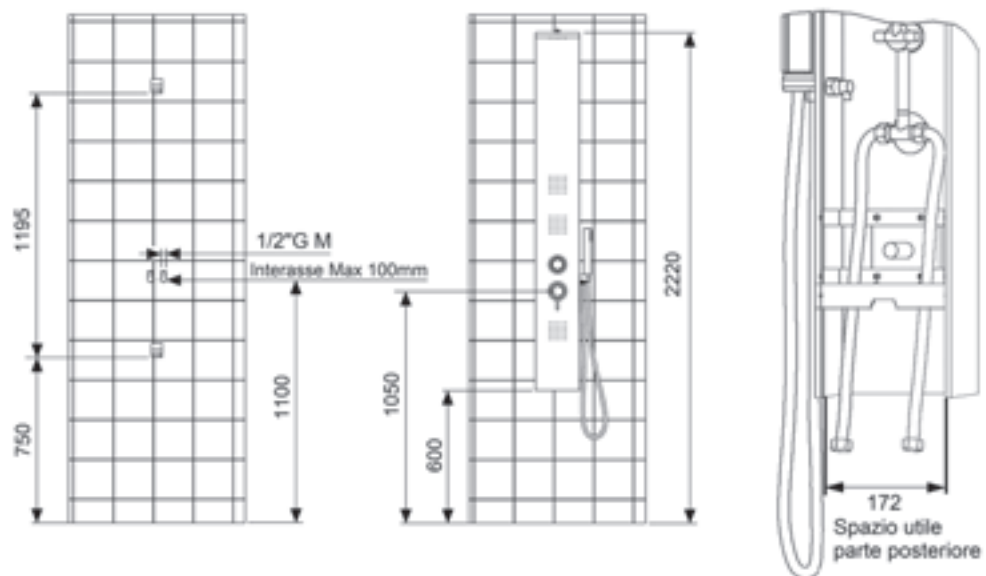
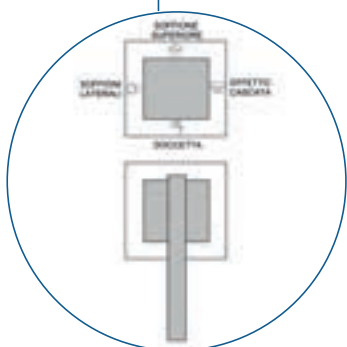

codice	UM	min. ord. conf.	cat.	prezzo (€)
● 1350907	NR	1	05	

ATENA COLONNA DOCCIA MULTIFUNZIONE ACCIAIO LUCIDO

Colonna in acciaio lucido multifunzione anticalcare con miscelatore. Senza copertura superiore. Portata 10 litri/min a 2 bar.

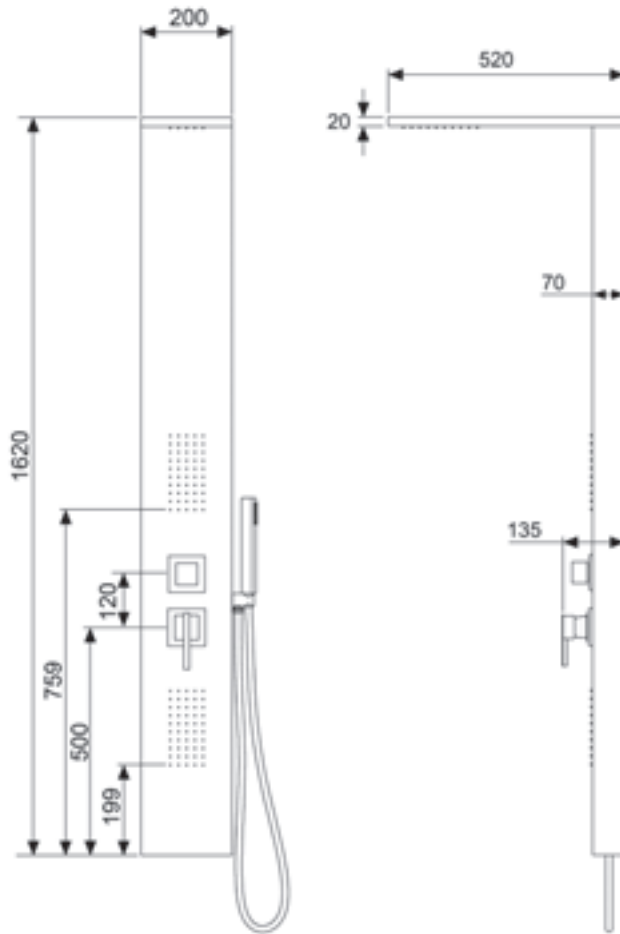

RICAMBI (PAG. 56-69)
1413089 - Cartuccia deviatore
1413085 - Cartuccia rubinetto

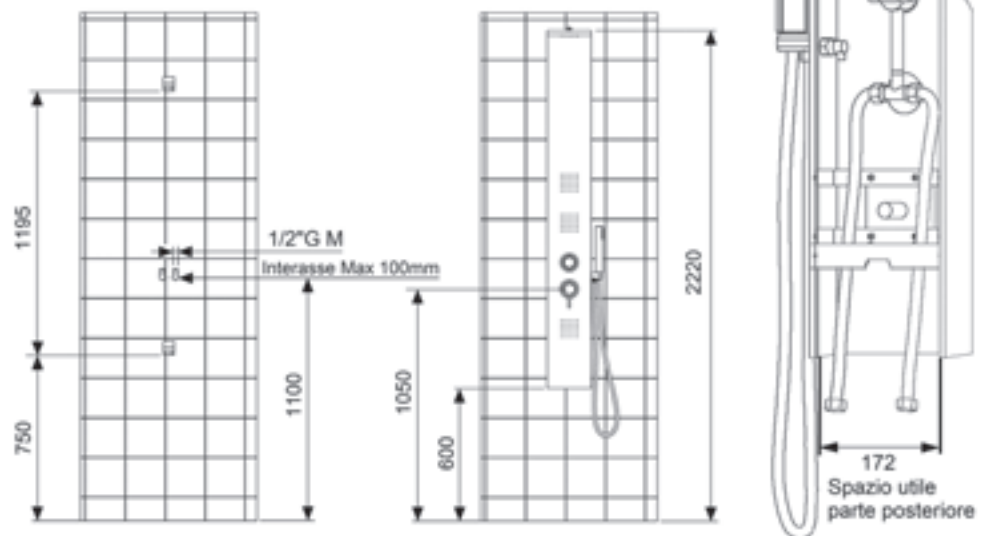
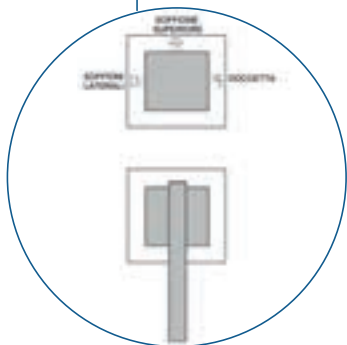

codice	UM	min. ord. conf.	cat.	prezzo (€)
● 1350908	NR	1	05	

LINEA DOCCIA

NARCISO COLONNA DOCCIA CROMATA

Colonna doccia telescopica con doccetta rettangolare in ABS (1410036) e flessibile estensibile 150cm, attacco inferiore femmina 1/2", attacco soffione maschio 1/2".

LINEA DOCCIA



CON TERMOSTATICO QUADRATO

codice	descrizione	UM	pezzi	cat.	prezzo (€)
● 1350639	colonna	NR	1	04	
● 1431024	mix con deviatore incorporato	NR	1	03	



CON TERMOSTATICO BLISS TONDO COOL BODY

codice	descrizione	UM	pezzi	cat.	prezzo (€)
● 1350639	colonna	NR	1	04	
● 1431016	mix con deviatore incorporato	NR	1	03	



CON TERMOSTATICO

codice	descrizione	UM	pezzi	cat.	prezzo (€)
● 1350639	colonna	NR	1	04	
● 1431021	mix con deviatore incorporato	NR	1	03	



CON DOCCIA ESTERNO COOL BODY

codice	descrizione	UM	pezzi	cat.	prezzo (€)
● 1350639	colonna	NR	1	04	
● 1431015	mix con deviatore incorporato	NR	1	03	

CON FLESSIBILE

codice	descrizione	UM	pezzi	cat.	prezzo (€)
● 1350639	colonna	NR	1	04	
● 1414009	deviatore MF 1/2"	NR	1	02	
● 1414012	supporto inferiore	NR	1	02	
● 1406015	flessibile 60 cm. 1/2"	NR	1	15	

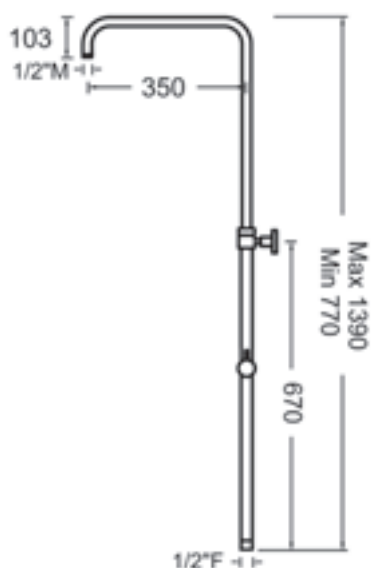

1414009



1414012

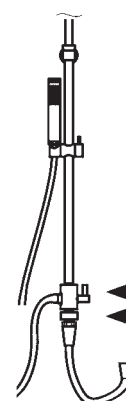

ATTENZIONE:
In fase di installazione rispettare l'ordine dei componenti:

← Deviatore
← Supporto a muro

SOFFIONE NON COMPRESO. Possibile abbinamento con i soffioni a pag.95-97-98

NARCISO COLONNA DOCCIA NERO OPACO

Colonna doccia telescopica con doccetta rettangolare in ABS e flessibile 150 cm, attacco inferiore femmina 1/2", attacco soffione maschio 1/2".



1359639

nero
opaco



1431916

CON TERMOSTATICO BLISS TONDO COOL BODY

codice	descrizione	UM	pezzi	cat.	prezzo (€)
● 1359639	colonna nero opaco	NR	1	04	
● 1431916	mix con deviatore incorporato nero opaco	NR	1	03	



1431915

CON DOCCIA ESTERNO COOL BODY

codice	descrizione	UM	pezzi	cat.	prezzo (€)
● 1359639	colonna nero opaco	NR	1	04	
● 1431915	mix con deviatore incorporato nero opaco	NR	1	03	

NARCISO COLONNA DOCCIA SIMIL ACCIAIO

Colonna doccia telescopica con doccetta rettangolare in ABS e flessibile 150 cm, attacco inferiore femmina 1/2", attacco soffione maschio 1/2".



1358639

simil
acciaio



1431816

CON TERMOSTATICO BLISS TONDO COOL BODY

codice	descrizione	UM	pezzi	cat.	prezzo (€)
● 1358639	colonna simil acciaio	NR	1	04	
● 1431816	mix con deviatore incorporato simil acciaio	NR	1	03	



1431815

CON DOCCIA ESTERNO COOL BODY

codice	descrizione	UM	pezzi	cat.	prezzo (€)
● 1358639	colonna simil acciaio	NR	1	04	
● 1431815	mix con deviatore incorporato simil acciaio	NR	1	03	

SOFFIONE NON COMPRESO. Possibile abbinamento con i soffioni a pag.95-97-98

LINEA DOCCIA

MAGNOLIA COLONNA DOCCIA

Colonna doccia telescopica con doccetta rettangolare in ABS (1410036) e flessibile estensibile 150cm, attacco inferiore femmina 1/2", attacco soffione maschio 1/2".

LINEA
DOCCIA



1431024

CON TERMOSTATICO QUADRATO

codice	descrizione	UM	pezzi	cat.	prezzo (€)
● 1350659	colonna	NR	1	04	
● 1431024	mix con deviatore incorporato	NR	1	03	



1431016

CON TERMOSTATICO BLISS TONDO COOL BODY

codice	descrizione	UM	pezzi	cat.	prezzo (€)
● 1350659	colonna	NR	1	04	
● 1431016	mix con deviatore incorporato	NR	1	03	



1431021

CON TERMOSTATICO

codice	descrizione	UM	pezzi	cat.	prezzo (€)
● 1350659	colonna	NR	1	04	
● 1431021	mix con deviatore incorporato	NR	1	03	



1431015

CON DOCCIA ESTERNO COOL BODY

codice	descrizione	UM	pezzi	cat.	prezzo (€)
● 1350659	colonna	NR	1	04	
● 1431015	mix con deviatore incorporato	NR	1	03	

CON FLESSIBILE

codice	descrizione	UM	pezzi	cat.	prezzo (€)
● 1350659	colonna	NR	1	04	
● 1414009	deviatore MF 1/2"	NR	1	02	
● 1414012	supporto inferiore	NR	1	02	
● 1406015	flessibile 60 cm. 1/2"	NR	1	15	

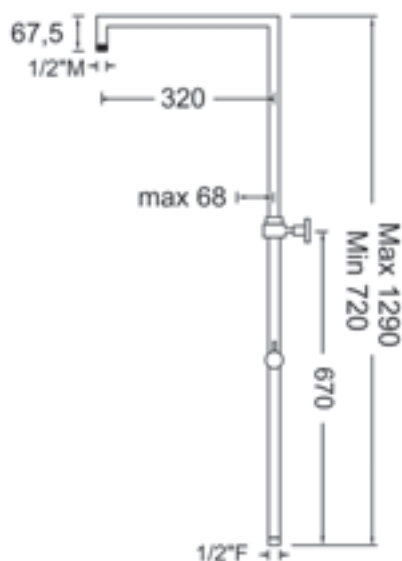

1414009



1414012

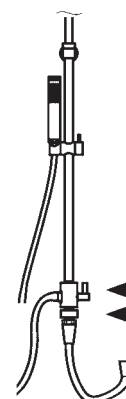

ATTENZIONE:
In fase di installazione rispettare l'ordine dei componenti:

← Deviatore
← Supporto a muro

SOFFIONE NON COMPRESO. Possibile abbinamento con i soffioni a pag.95-97-98

Colonna doccia telescopica con doccetta cilindrica monogetto in ABS (1412008) e flessibile estensibile 150cm, attacco inferiore femmina 1/2", attacco soffione maschio 1/2".



1350649



1431016

CON TERMOSTATICO BLISS TONDO COOL BODY

codice	descrizione	UM	pezzi	cat.	prezzo (€)
● 1350649	colonna	NR	1	04	
● 1431016	mix con deviatore incorporato	NR	1	03	



1431021

CON TERMOSTATICO

codice	descrizione	UM	pezzi	cat.	prezzo (€)
● 1350649	colonna	NR	1	04	
● 1431021	mix con deviatore incorporato	NR	1	03	



1431015

CON DOCCIA ESTERNO COOL BODY

codice	descrizione	UM	pezzi	cat.	prezzo (€)
● 1350649	colonna	NR	1	04	
● 1431015	mix con deviatore incorporato	NR	1	03	

CON FLESSIBILE

codice	descrizione	UM	pezzi	cat.	prezzo (€)
● 1350649	colonna	NR	1	04	
● 1414009	deviatore MF 1/2"	NR	1	02	
● 1414012	supporto inferiore	NR	1	02	
● 1406015	flessibile 60 cm. 1/2"	NR	1	15	

1414009



1414012

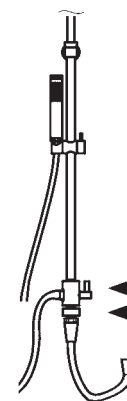
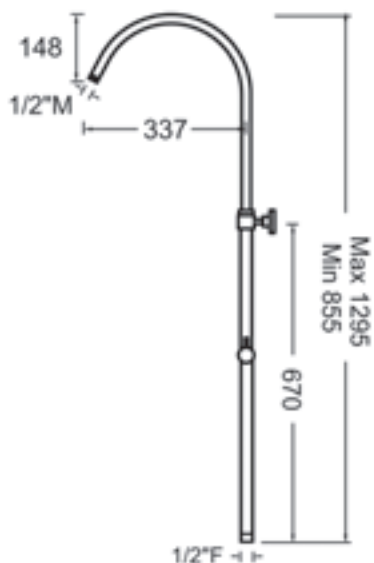

ATTENZIONE:
In fase di installazione rispettare l'ordine dei componenti:

← Deviatore
← Supporto a muro

SOFFIONE NON COMPRESO. Possibile abbinamento con i soffioni a pag.95-97-98

LINEA DOCCIA

SALISCENDI

CRYSTAL

Set composto da: asta doccia in ottone 30x10 mm., doccetta CRYSTAL monogetto in ABS (1410036), flessibile doppia aggiratura da 150 cm. (1406003), kit fissaggio.

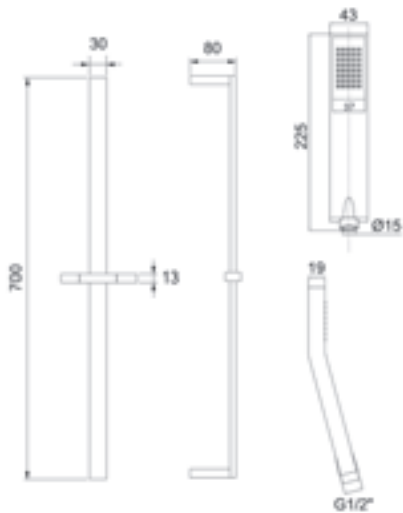

LINDA 3 GETTI

Set composto da: asta doccia completamente in ottone D.20 mm. da 90 cm. con un supporto regolabile, doccetta LINDA a 3 getti D.112 mm. (1410028), flessibile plastico silver da 150 cm. (1407003), kit di fissaggio.

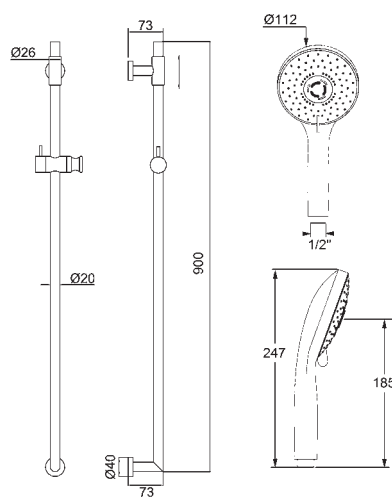

CINDY 2 GETTI

Set composto da: asta doccia completamente in ottone D.20 da 76 cm., doccetta CINDY a 2 getti D.125 mm. (1410021), flessibile doppia aggiratura da 150 cm. (1406003), kit di fissaggio.

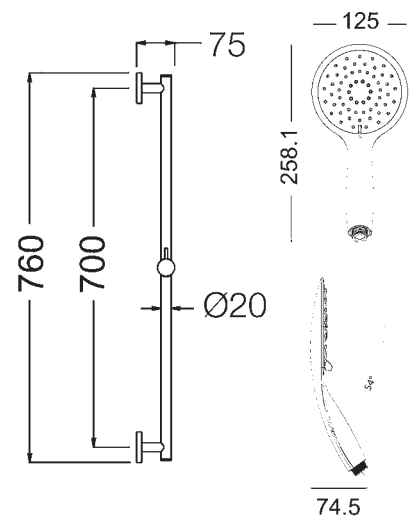

codice	UM	min. ord.	conf.	cat.	prezzo (€)
● 1323001	NR	1	10	01	

codice	finitura	UM	min. ord.	conf.	cat.	prezzo (€)
● 1319001	cromo	NR	1	10	01	
● 1319901	nero opaco	NR	1	1	01	
1319801	simil acciaio	NR	1	1	01	

codice	UM	min. ord.	conf.	cat.	prezzo (€)
● 1316001	NR	1	1	01	

KELLY 5 GETTI

Set composto da: asta doccia in inox D.25 mm. da 71 cm. con un supporto regolabile, portasapone trasparente, doccetta KELLY a 5 getti D.100 mm., flessibile doppia aggiratura da 150 cm. (1406003), kit di fissaggio.

RICAMBI (PAG. 113)
1411004 - Corsore



ELISA 3 GETTI

Set composto da: asta doccia in inox D.25 mm. da 70 cm. con entrambi i supporti regolabili, portasapone cromato, doccetta ELISA a 3 getti D.100 mm. (1410030), flessibile doppia aggiratura da 150 cm. (1406003), kit di fissaggio.



DIANA 5 GETTI

Set composto da: asta doccia in inox D.25 mm. da 58 cm., portasapone cromato, doccetta DIANA a 5 getti D.112 mm. (1410034), flessibile doppia aggiratura da 150 cm. (1406003), kit di fissaggio.

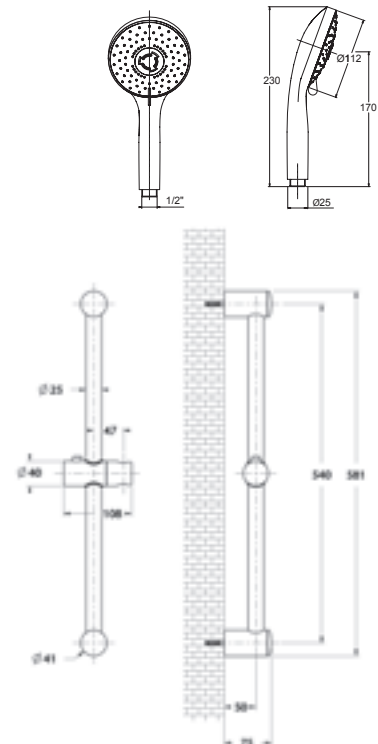
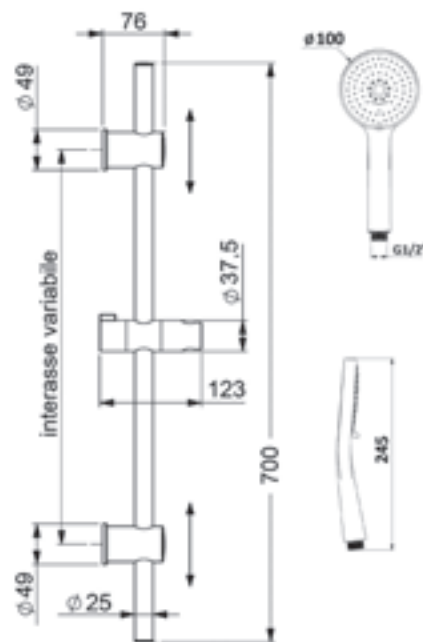
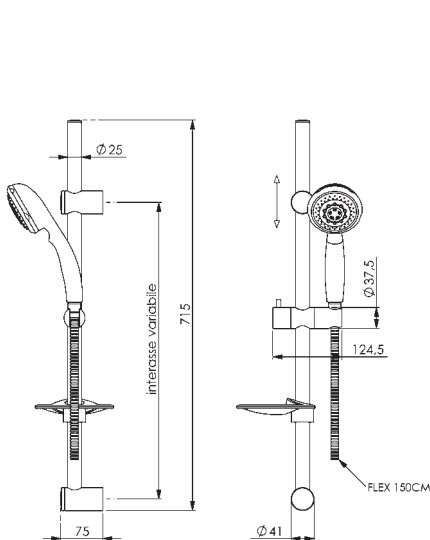

codice	UM	min. ord.	conf.	cat.	prezzo (€)
● 1311001	NR	1	10	01	

codice	UM	min. ord.	conf.	cat.	prezzo (€)
● 1320001	NR	1	10	01	

codice	UM	min. ord.	conf.	cat.	prezzo (€)
● 1321001	NR	1	10	01	

LINEA DOCCIA

SALISCENDI

MARINE 5 GETTI

Set composto da: asta doccia in inox D.25 mm. da 65 cm., portasapone cromato, doccetta MARINE a 5 getti D.90 mm. (1410003), flessibile da 150 cm., kit di fissaggio.

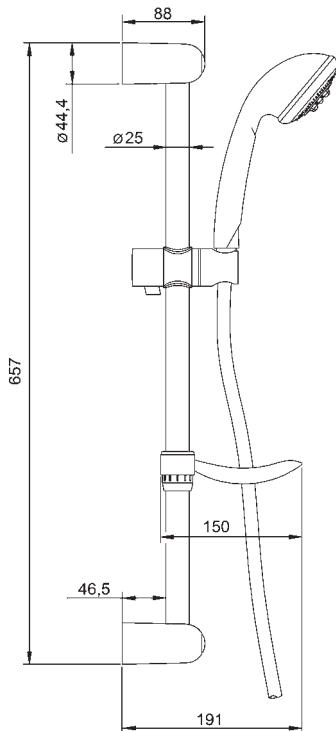

codice	UM	min. ord.	conf.	cat.	prezzo (€)
● 1322001	NR	1	10	01	

GROHE TEMPESTA 100, 2 GETTI

Set composto da: asta doccia metallica D.22 mm. da 60 cm. doccetta TEMPESTA a 2 getti D. 100 mm. (27597001), flessibile silver da 175 cm., kit fissaggio.

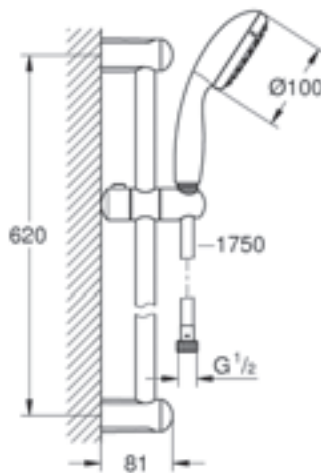

codice	UM	min. ord.	conf.	cat.	prezzo (€)
● 27598001	NR	1	24	11	

GROHE TEMPESTA 100, 3 GETTI

Set composto da: asta doccia metallica D.22 mm. da 60 cm., doccetta TEMPESTA a 3 getti D. 100 mm. (28261002), flessibile silver da 175 cm., kit fissaggio.

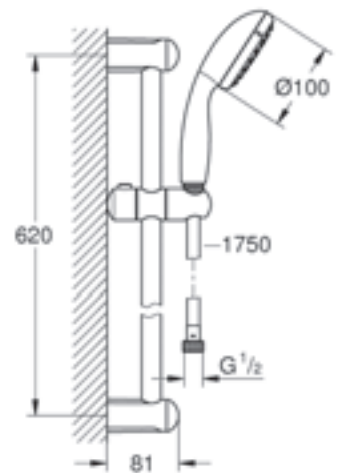

codice	UM	min. ord.	conf.	cat.	prezzo (€)
● 27794001	NR	1	20	11	

GROHE TEMPESTA 100, 3 GETTI, C/PORTASAPONE

Set composto da: asta doccia metallica D.22 mm. da 60 cm., doccetta TEMPESTA a 3 getti D. 100 mm. (28261002), flessibile silver da 175 cm., kit fissaggio.

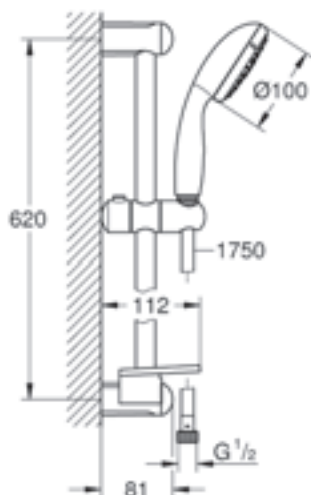

GROHE TEMPESTA 100, 4 GETTI

Set composto da: asta doccia metallica D.22 mm. da 60 cm., doccetta TEMPESTA a 4 getti D. 100 mm., mensola porta oggetti 222x91 mm., flessibile silver da 175 cm., kit fissaggio.

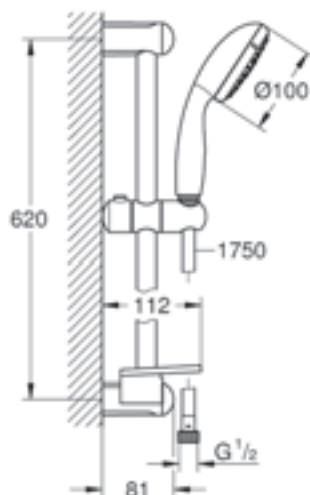

GROHE RAINSHOWER SMARTACTIVE 150, 3 GETTI

Set composto da: asta doccia completamente metallica D.25 mm. da 90 cm., doccetta RAINSHOWER SMARTACTIVE a 3 getti D 150 mm. con portata limitata a 9,5 lt/min., mensola porta oggetti 210x100 mm.

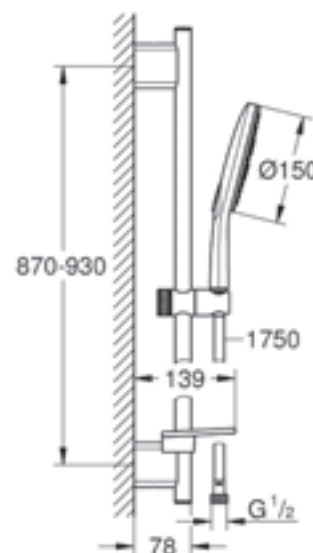

codice	UM	min. ord.	conf.	cat.	prezzo (€)
● 27600001	NR	1	20	11	

codice	UM	min. ord.	conf.	cat.	prezzo (€)
● 28593002	NR	1	20	11	

codice	UM	min. ord.	conf.	cat.	prezzo (€)
● 26594000	NR	1	12	11	

LINEA DOCCIA

LINEA DOCCIA

SALISCENDI

GROHE EUPHORIA 110 CHAMPAGNE, 3 GETTI

Set composto da: asta doccia metallica D.22 mm. da 60 cm. con supporti in abs regolabili, doccetta EUPHORIA CHAMPAGNE a 3 getti D. 110 mm., mensola porta oggetti 222x91 mm., flessibile silver da 175 cm., kit fissaggio.

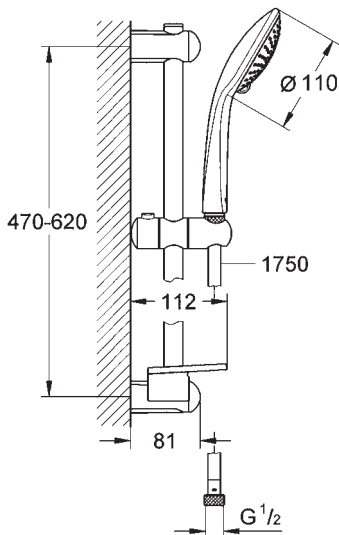

GROHE EUPHORIA 110 MASSAGE, 3 GETTI

Set composto da: asta doccia metallica D.22 da 90 cm. con supporti in abs regolabili, doccetta MASSAGE a 3 getti D. 110 mm., mensola porta oggetti 222x91 mm., flessibile silver da 175 cm., kit fissaggio.

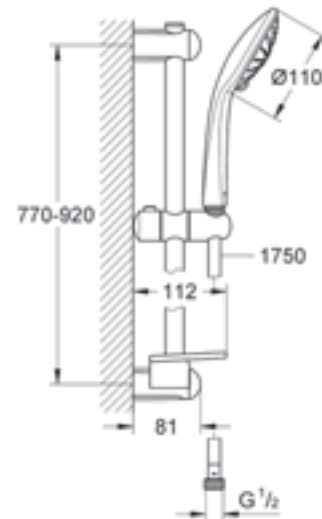

codice	UM	min. ord.	conf.	cat.	prezzo (€)
● 27232001	NR	1	20	11	

codice	UM	min. ord.	conf.	cat.	prezzo (€)
● 27226001	NR	1	12	11	

SOFFIONE DOPPIO A MURO CON CASCATA

Anticalcare, con soffione a cascata separata.



codice	dimensioni (mm)	UM	min. ord. conf.	cat.	prezzo (€)
● 1403080	490x180	NR	1	05	

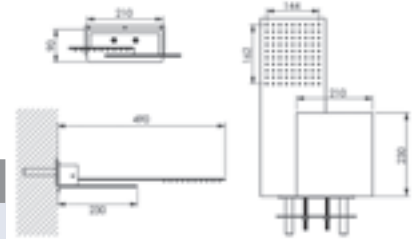

SQUARE

Anticalcare ed ispezionabile.
Portata litri/min: 14



codice	dimensioni (mm)	finitura	UM	min. ord. conf.	cat.	prezzo (€)
● 1403018	200	cromo	NR	1	10	01
● 1403918	200	nero opaco	NR	1	1	01
● 1403057	250	cromo	NR	1	6	01
● 1403957	250	nero opaco	NR	1	1	01
● 1403042	300	cromo	NR	1	5	01

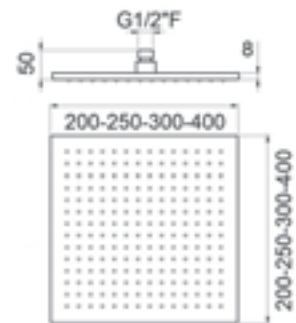

PITCH RETTANGOLARE

Anticalcare ed ispezionabile
Portata litri/minuto: 12



codice	dimensioni (mm)	UM	min. ord. conf.	cat.	prezzo (€)
● 1403020	245x140	NR	1	10	01
● 1403060	340x220	NR	1	1	01

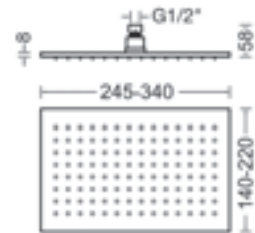

ROUND

Anticalcare ed ispezionabile
Portata litri/minuto: 14

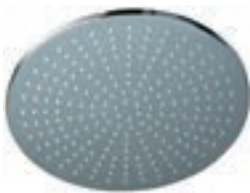

codice	dimensioni (mm)	finitura	UM	min. ord. conf.	cat.	prezzo (€)
● 1403021	200	cromo	NR	1	10	01
● 1403921	200	nero opaco	NR	1	1	01
● 1403052	250	cromo	NR	1	6	01
● 1403952	250	nero opaco	NR	1	1	01
● 1403037	300	cromo	NR	1	5	01

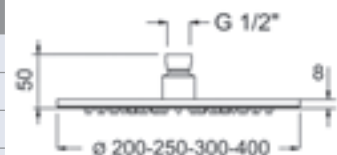

SHOWER BELL

Non ispezionabile
Portata litri/minuto: 15,9



codice	dimensioni (mm)	UM	min. ord. conf.	cat.	prezzo (€)
● 1403024	208	NR	1	8	01

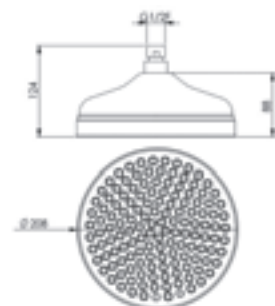

LINEA DOCCIA

SOFFIONI DOCCIA INOX

LINEA DOCCIA

SQUARE SOFFIONE A MURO C/CASCATA

Anticalcare ed ispezionabile, parte superiore chiusa.
Portata litri/minuto: **6,6** pioggia
7,7 cascata

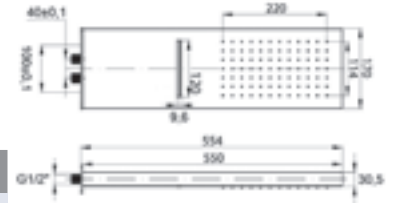

codice	dimensioni (mm)	UM	min. ord.	conf.	cat.	prezzo (€)
● 1403085	550x170x30	NR	1	1	15	

SQUARE SOFFIONE A MURO SENZA CASCATA

Anticalcare ed ispezionabile, parte superiore chiusa.
Portata litri/minuto: **6,6** pioggia

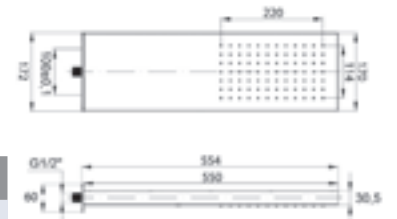

codice	dimensioni (mm)	UM	min. ord.	conf.	cat.	prezzo (€)
● 1403086	550x170x30	NR	1	1	15	

SOFFIONE A MURO CON CASCATA E NEBULIZZATORE

Anticalcare, parte superiore chiusa.
Il soffione ha 3 getti miscelabili a bottoni:

- getto tradizionale
- getto a cascata
- getto nebulizzato "effetto nebbia"
- ideale per ristrutturazioni

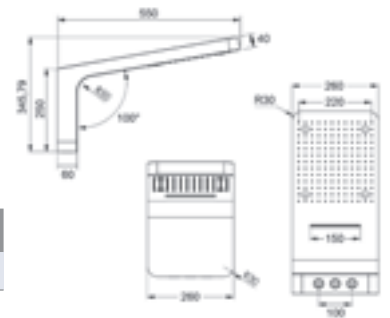

codice	dimensioni (mm)	UM	min. ord.	conf.	cat.	prezzo (€)
● 1403081	555x300	NR	1	1	05	

QUADRO A MURO CON CASCATA

Anticalcare, senza copertura superiore.
Portata litri/minuto: **6**

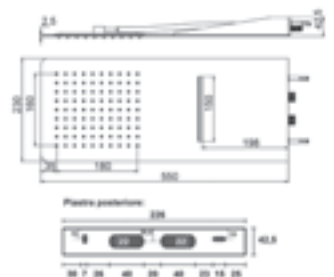

codice	dimensioni (mm)	UM	min. ord.	conf.	cat.	prezzo (€)
● 1403050	550x230x2,5	NR	1	3	02	

QUADRO A MURO SENZA CASCATA

Anticalcare, senza copertura superiore.
Portata litri/minuto: **6**

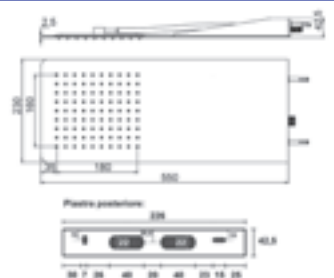

codice	dimensioni (mm)	UM	min. ord.	conf.	cat.	prezzo (€)
● 1403051	550x230x2,5	NR	1	3	02	

TONDO A MURO CON CASCATA



Anticalcare, senza copertura superiore.
Portata litri/minuto: **6**

codice	dimensioni (mm)	UM	min. ord.	conf.	cat.	prezzo (€)
● 1403061	550x230x2,5	NR	1	3	02	

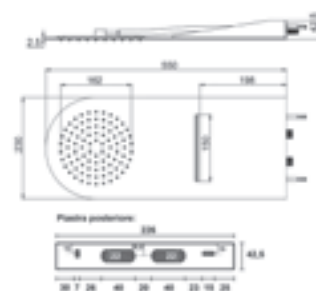

TONDO A MURO SENZA CASCATA



Anticalcare, senza copertura superiore.
Portata litri/minuto: **6**

codice	dimensioni (mm)	UM	min. ord.	conf.	cat.	prezzo (€)
● 1403062	550x230x2,5	NR	1	3	02	

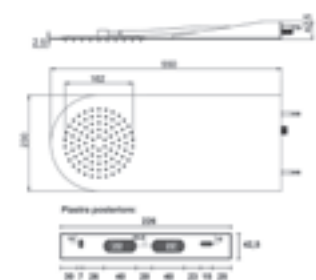

SQUARE



Anticalcare
Portata litri/minuto: **9,3**

codice	dimensioni (mm)	UM	min. ord.	conf.	cat.	prezzo (€)
● 1403064	150	NR	1	06		
● 1403035	200	NR	1	06		
● 1403059	250	NR	1	06		
● 1403041	300	NR	1	06		
● 1403084	400	NR	1	06		

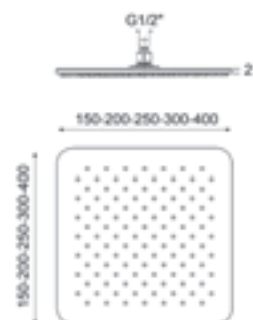

PLENTY SQUARE



Angoli smussati. Anticalcare
Portata litri/minuto: **8,1**

codice	dimensioni (mm)	UM	min. ord.	conf.	cat.	prezzo (€)
● 1403054	200	NR	1	12	06	
● 1403068	250	NR	1	7	06	
● 1403056	300	NR	1	5	06	

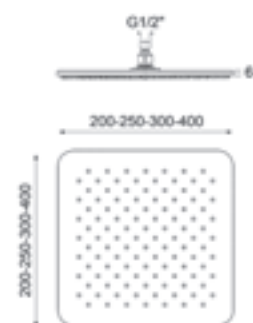

PITCH RETTANGOLARE



Ultrasottile. Anticalcare.
Portata litri/minuto: **7,3**

codice	dimensioni (mm)	UM	min. ord.	conf.	cat.	prezzo (€)
● 1403065	300x200	NR	1	8	06	

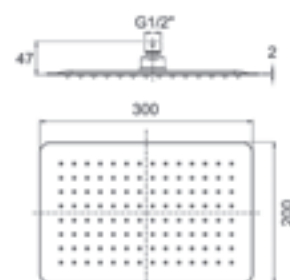

LINEA DOCCIA

SOFFIONI DOCCIA INOX

ROUND

Anticalcare
Portata litri/minuto: **9,6**



	codice	dimensioni (mm)	UM	min. ord. conf.	cat.	prezzo (€)
●	1403063	150	NR	1	06	
●	1403033	200	NR	1	06	
●	1403058	250	NR	1	06	
●	1403034	300	NR	1	06	
●	1403083	400	NR	1	06	



PLENTY ROUND

Anticalcare
Portata litri/minuto: **7,6**



	codice	dimensioni (mm)	UM	min. ord. conf.	cat.	prezzo (€)
●	1403053	200	NR	1	12	06
●	1403066	250	NR	1	7	06
●	1403055	300	NR	1	5	06



SOFFIONI DOCCIA ABS

ECO SQUARE

Anticalcare ed ispezionabile
Portata litri/minuto: **16**

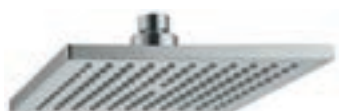

	codice	dimensioni (mm)	UM	min. ord. conf.	cat.	prezzo (€)
●	1403046	200	NR	1	02	

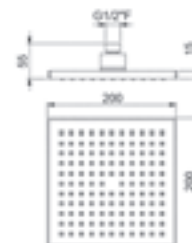

ECO ROUND

Anticalcare ed ispezionabile
Portata litri/minuto: **14,5**



	codice	dimensioni (mm)	UM	min. ord. conf.	cat.	prezzo (€)
●	1403047	200	NR	1	02	

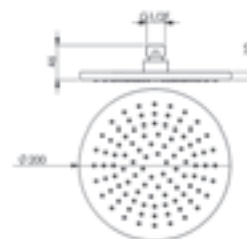

TORINO 1 FUNZIONE



In ottone a 1 funzione

codice	dimensioni (mm)	UM	min. ord. conf.	cat.	prezzo (€)
● 1403040	70	NR	1	02	

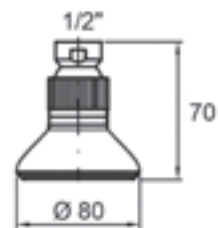

COMO 1 FUNZIONE



In ottone a 1 funzione
Portata litri/minuto: 17

codice	dimensioni (mm)	UM	min. ord. conf.	cat.	prezzo (€)
● 1403009	82	NR	1	06	

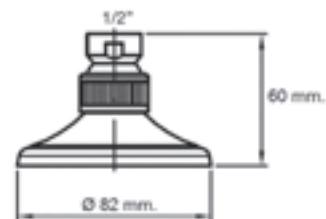

LISBONA 1 FUNZIONE



In ABS cromato
Portata litri/minuto: 34

codice	dimensioni (mm)	UM	min. ord. conf.	cat.	prezzo (€)
● 1403048	62	NR	1	06	

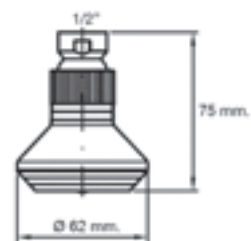

RIMINI 1 FUNZIONE



In ABS cromato

codice	dimensioni (mm)	UM	min. ord. conf.	cat.	prezzo (€)
● 1403017	90	NR	1	02	



GRETA 3 FUNZIONI



In ABS cromato
Portata litri/minuto: 10

codice	dimensioni (mm)	UM	min. ord. conf.	cat.	prezzo (€)
● 1403006	80	NR	1	02	

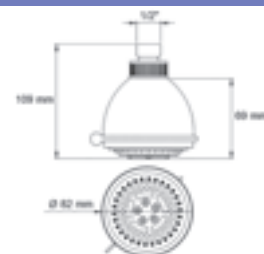

PARIGI 5 FUNZIONI



Anticalcare
In ABS cromato
Portata litri/minuto: 15

codice	dimensioni (mm)	UM	min. ord. conf.	cat.	prezzo (€)
● 1403049	108	NR	1	02	

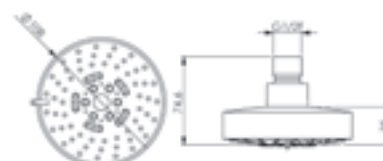

LINEA DOCCIA

BRACCI DOCCIA

MODENA

In ottone



codice	dimensioni (cm)	UM	min. ord. conf.	cat.	prezzo (€)
● 1405001	18	NR	1	02	

VIGEVANO

In ottone
Ø 18 mm



codice	dimensioni (cm)	UM	min. ord. conf.	cat.	prezzo (€)
● 1405004	20	NR	1	10	06
● 1405021	25	NR	1	10	06
● 1405005	30	NR	1	10	06



RAVENNA

In ottone
Ø 22 mm



codice	dimensioni (cm)	finitura	UM	min. ord. conf.	cat.	prezzo (€)
● 1405006	30	cromo	NR	1	02	
● 1405906	30	nero opaco	NR	1	02	
● 1405806	30	simil acciaio	NR	1	02	
● 1405035	35	cromo	NR	1	02	
● 1405935	35	nero opaco	NR	1	02	
● 1405835	35	simil acciaio	NR	1	02	
● 1405019	40	cromo	NR	1	02	

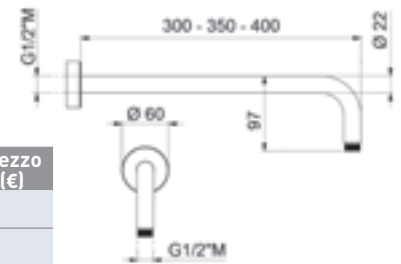

RAVENNA 50

In ottone
Ø 23 mm



codice	dimensioni (cm)	UM	min. ord. conf.	cat.	prezzo (€)
● 1405007	50	NR	1	02	

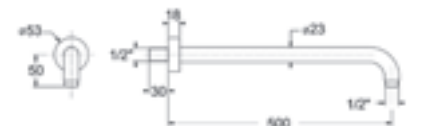

BOLOGNA

In ottone con doppio rosone (tondo e quadrato)
Ø 20 mm



codice	dimensioni (cm)	UM	min. ord. conf.	cat.	prezzo (€)
● 1405024	33	NR	1	25	02

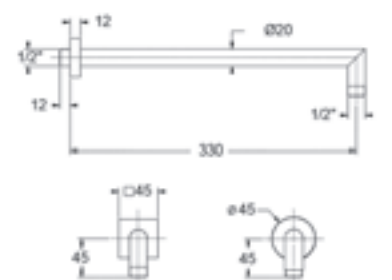

POSTUMIA QUADRATO



In ottone
L. 25x25 mm

codice	dimensioni (cm)	UM	min. ord. conf.	cat.	prezzo (€)
● 1405014	30	NR	1	02	

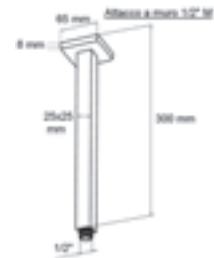

POSTUMIA TONDO



In ottone
Ø 22 mm

codice	dimensioni (cm)	UM	min. ord. conf.	cat.	prezzo (€)
● 1405013	30	NR	1	02	

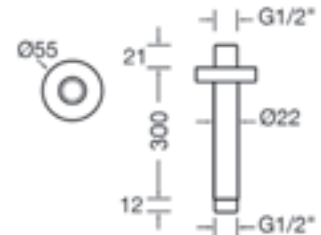

MANTOVA



In ottone
L. 25x25 mm



codice	dimensioni (cm)	finitura	UM	min. ord. conf.	cat.	prezzo (€)
● 1405017	30	cromo	NR	1	30	02
● 1405917	30	nero opaco	NR	1	1	02
● 1405817	30	simil acciaio	NR	1	1	02
● 1405011	35	cromo	NR	1	30	02
● 1405911	35	nero opaco	NR	1	1	02
● 1405811	35	simil acciaio	NR	1	1	02
● 1405018	40	cromo	NR	1	30	02

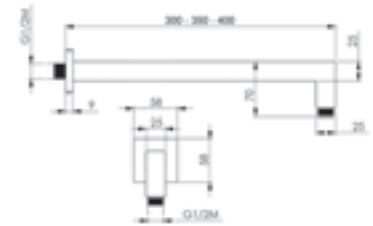

VIENNA



In ottone
L. 35x15 mm

codice	dimensioni (cm)	UM	min. ord. conf.	cat.	prezzo (€)
● 1405038	40	NR	1	02	



PRAGA



In ottone
Ø 25 mm

codice	dimensioni (cm)	UM	min. ord. conf.	cat.	prezzo (€)
● 1405037	40	NR	1	02	

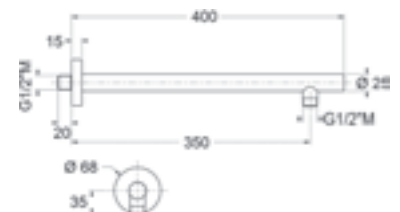

BRACCIO DOCCIA CON DEVIATORE



In ottone Ø 20 mm
Il deviatore si attiva tirando con cura verso il basso il flessibile. Chiudendo l'acqua, in assenza di pressione, il deviatore torna automatico sul soffione.

codice	dimensioni (cm)	UM	min. ord. conf.	cat.	prezzo (€)
● 1405036	30 + 6 (dev.)	NR	1	02	

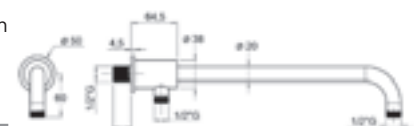

DEVIATORE

LINEA DOCCIA

DOCCETTE

ENERGY



In ABS cromato 5 getti anticalcare con regolatore di flusso
Portata litri/minuto: **13,6**

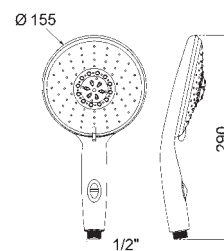

codice	Ø (mm)	UM	min. ord. conf.	cat.	prezzo (€)
● 1410002	155	NR	1	06	

VITTORIA



In ABS cromato 5 getti anticalcare
Portata litri/minuto: **9**



codice	Ø (mm)	UM	min. ord. conf.	cat.	prezzo (€)
● 1410023	120	NR	1	06	

MARINE



In ABS cromato 5 getti anticalcare
Portata litri/minuto: **10,4**

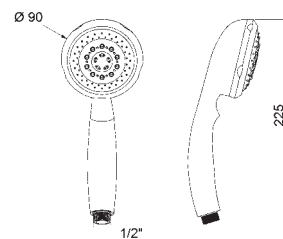

codice	Ø (mm)	UM	min. ord. conf.	cat.	prezzo (€)
● 1410003	90	NR	1	06	

DIANA



In ABS cromo/grigio 5 getti anticalcare
Portata litri/minuto: **15,9**

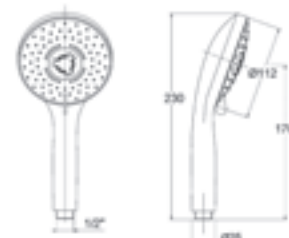

codice	Ø (mm)	UM	min. ord. conf.	cat.	prezzo (€)
● 1410034	112	NR	1	06	

LINDA



In ABS cromato 3 getti anticalcare
Portata litri/minuto: **12,3**

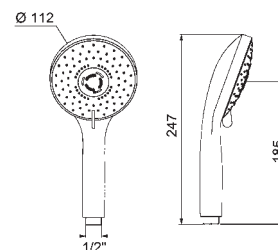

codice	Ø (mm)	UM	min. ord. conf.	cat.	prezzo (€)
● 1410028	112	NR	1	06	

ELISA



In ABS cromato 3 getti anticalcare, con sistema risparmio acqua
Portata litri/minuto: **7,7**

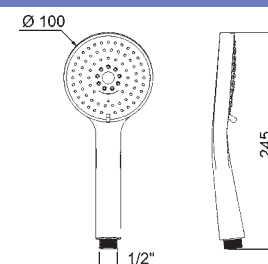

codice	Ø (mm)	UM	min. ord. conf.	cat.	prezzo (€)
● 1410030	100	NR	1	06	

SANDY 3



In ABS cromato 3 getti anticalcare
Portata litri/minuto: **5,3**

codice	Ø (mm)	UM	min. ord. conf.	cat.	prezzo (€)
● 1410025	77	NR	1	06	

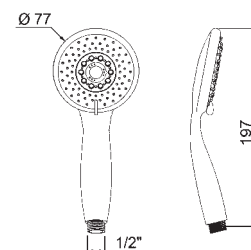

CINDY



In ABS cromato 2 getti anticalcare
Portata litri/minuto: **9,2**

codice	Ø (mm)	UM	min. ord. conf.	cat.	prezzo (€)
● 1410021	125	NR	1	06	



METEOR



In ABS cromato 1 getto anticalcare
Portata litri/minuto: **15,6**

codice	Ø (mm)	UM	min. ord. conf.	cat.	prezzo (€)
● 1410019	80	NR	1	06	



SANDY 1



In ABS cromato 1 getto anticalcare
Portata litri/minuto: **15**

codice	Ø (mm)	UM	min. ord. conf.	cat.	prezzo (€)
● 1410024	80	NR	1	06	



GROHE TEMPESTA 100 DOCCETTA, 3 GETTI



In ABS cromato 3 getti anticalcare

codice	Ø (mm)	UM	min. ord. conf.	cat.	prezzo (€)
● 28261002	100	NR	1	50	11

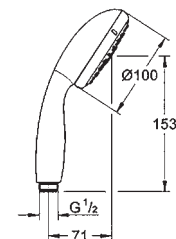

GROHE TEMPESTA 100 DOCCETTA, 2 GETTI



In ABS cromato 2 getti anticalcare

codice	Ø (mm)	UM	min. ord. conf.	cat.	prezzo (€)
● 27597001	100	NR	1	50	11

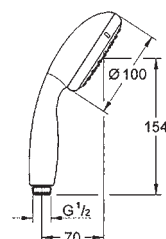

LINEA DOCCIA

DOCCETTE

DOCCETTA RETTANGOLARE OTTONE



In ottone, anticalcare
PORTATA litri/minuto: **23,2**



codice	sez. (mm)	lung. (mm)	UM	min. ord. conf.	cat.	prezzo (€)
● 1412002	35x15	229	NR	1	06	

DOCCETTA TONDA OTTONE



In ottone, anticalcare
PORTATA litri/minuto: **23,2**



codice	sez. (mm)	lung. (mm)	UM	min. ord. conf.	cat.	prezzo (€)
● 1412001	Ø 24	200	NR	1	06	

DOCCETTA A CAMPANA OTTONE



In ottone, anticalcare
PORTATA litri/minuto: **25**

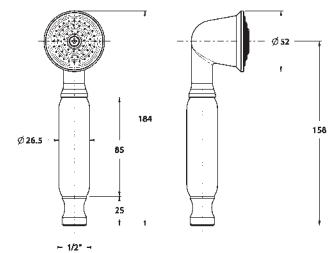

codice	sez. (mm)	lung. (mm)	UM	min. ord. conf.	cat.	prezzo (€)
● 1412003	Ø 52	184	NR	1	06	

DOCCETTA QUADRATA ABS



In ABS, anticalcare
PORTATA litri/minuto: **25,8**



codice	sez. (mm)	lung. (mm)	UM	min. ord. conf.	cat.	prezzo (€)
● 1412009	28x28	230	NR	1	06	

DOCCETTA TONDA ABS



In ABS, anticalcare
PORTATA litri/minuto: **17**



codice	finitura	sez. (mm)	lung. (mm)	UM	min. ord. conf.	cat.	prezzo (€)
● 1412008	cromo	Ø 32	210	NR	1	06	
1412908	nero opaco	Ø 32	210	NR	1	06	
1412808	simil acciaio	Ø 32	210	NR	1	06	

CRYSTAL



In ABS cromato, anticalcare
PORTATA litri/minuto: **14,2**



codice	sez. (mm)	lung. (mm)	UM	min. ord. conf.	cat.	prezzo (€)
● 1410036	43x19	225	NR	1	06	

QUADRA OTTONE CON PRESA ACQUA

Set composto da: doccetta rettangolare in ottone (1412002*), presa d'acqua centrale quadrata (1409007*), **flessibile silver 150 cm.** (1407003*)

*solo versione cromo

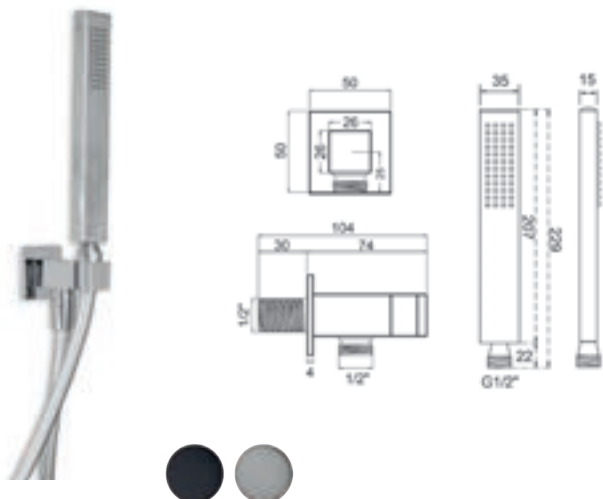

codice	finitura	UM	min. ord.	conf.	cat.	prezzo (€)
● 1409010	cromo	NR	1	20	02	
● 1409910	nero opaco	NR	1	1	02	
1409810	simil acciaio	NR	1	1	02	

QUADRA OTTONE CON PRESA ACQUA

Set composto da: doccetta rettangolare in ottone (1412002), presa d'acqua centrale quadrata (1409007), **flessibile doppia aggraffatura 150 cm.** (1406003)

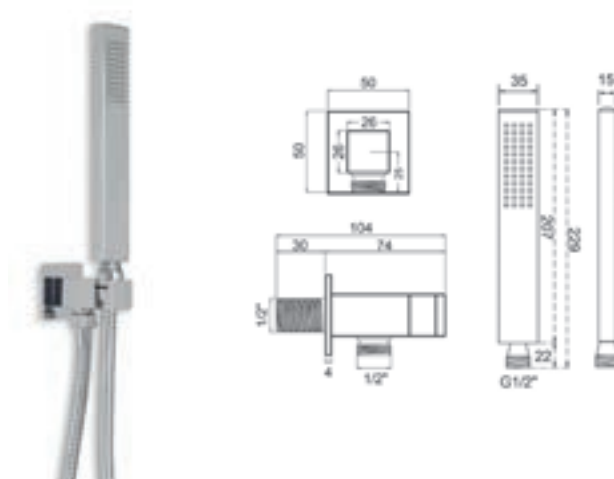

codice	UM	min. ord.	conf.	cat.	prezzo (€)
● 1409021	NR	1	20	02	

TONDA OTTONE CON PRESA ACQUA

Set composto da: doccetta tonda in ottone (1412001*), presa d'acqua centrale tonda (1409008*), **flessibile silver 150 cm.** (1407003*)

*solo versione cromo

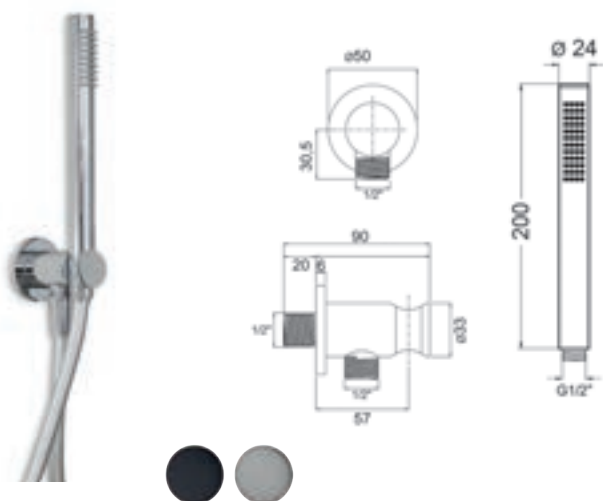

codice	finitura	UM	min. ord.	conf.	cat.	prezzo (€)
● 1409012	cromo	NR	1	20	02	
● 1409912	nero opaco	NR	1	1	02	
1409812	simil acciaio	NR	1	1	02	

TONDA OTTONE CON PRESA ACQUA

Set composto da: doccetta tonda in ottone (1412001), presa d'acqua centrale tonda (1409008), **flessibile doppia aggraffatura 150 cm.** (1406003)

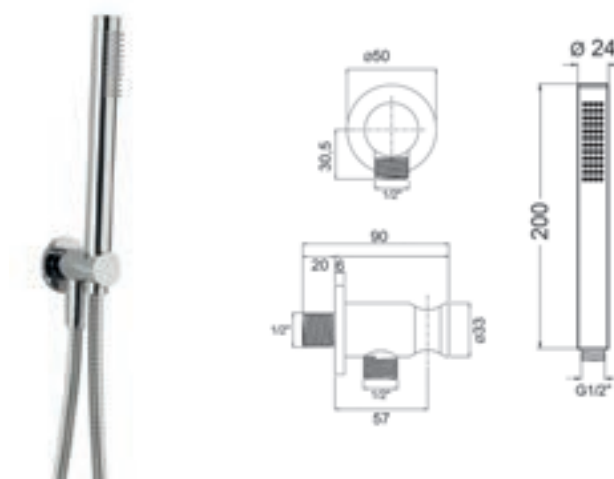

codice	UM	min. ord.	conf.	cat.	prezzo (€)
● 1409022	NR	1	20	02	

LINEA DOCCIA

SET DOCCIA

LINEA DOCCIA

TONDA ABS CON PRESA ACQUA

Set composto da: doccetta tonda in ABS (1412008), presa d'acqua centrale tonda (1409008), **flessibile silver 150 cm.** (1407003)

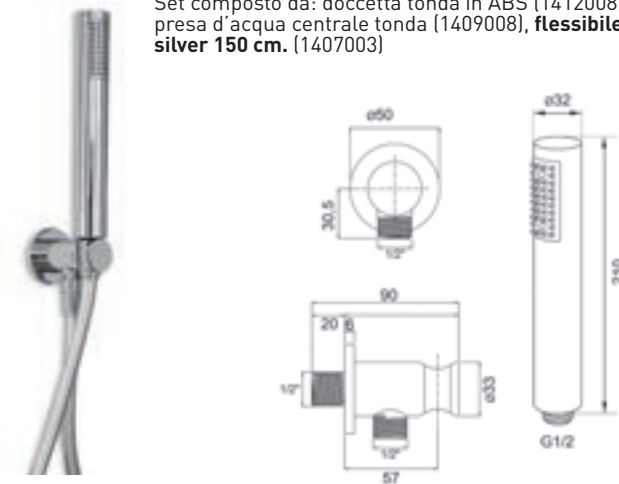

codice	UM	min. ord.	conf.	cat.	prezzo (€)
● 1409013	NR	1	20	02	

QUADRA ABS CON PRESA ACQUA

Set composto da: doccetta quadrata in ABS (1412009), presa d'acqua centrale quadrata (1409007), **flessibile silver 150 cm.** (1407003)

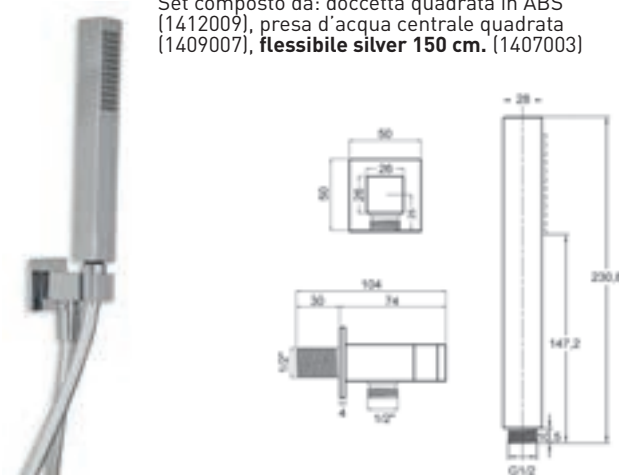

codice	UM	min. ord.	conf.	cat.	prezzo (€)
● 1409011	NR	1	20	02	

PRESE ACQUA

TONDA CON DUPLEX

In ottone, orientabile.



codice	attacchi	UM	min. ord.	conf.	cat.	prezzo (€)
● 1409005	1/2" M x 1/2" M	NR	1	50	02	

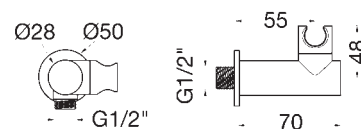

QUADRA DUPLEX

In ottone, orientabile.



codice	attacchi	UM	min. ord.	conf.	cat.	prezzo (€)
● 1409004	1/2" M x 1/2" M	NR	1	20	02	

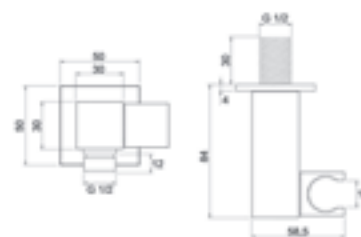

TONDA CENTRALE

In ottone, attacchi 1/2" maschio.



codice	finitura	UM	min. ord.	conf.	cat.	prezzo (€)
● 1409008	cromo	NR	1	44	02	
1409908	nero opaco	NR	1	1	02	
1409808	simill acciaio	NR	1	1	02	

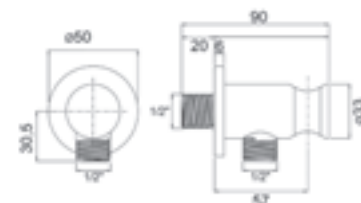

QUADRATA CENTRALE



In ottone

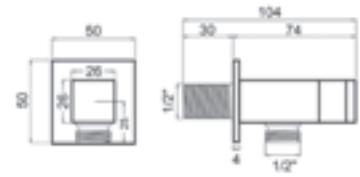

codice	attacchi	UM	min. ord.	conf.	cat.	prezzo (€)
● 1409007	1/2" M x 1/2" M	NR	1	44	02	

TONDA STICK CON RUBINETTO CHIUSURA



In ottone

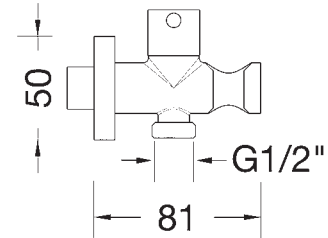

codice	attacchi	UM	min. ord.	conf.	cat.	prezzo (€)
● 1409024	1/2" M x 1/2" M	NR	1	02		

TONDA CON RUBINETTO CHIUSURA



In ottone

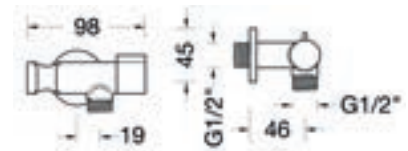

codice	attacchi	UM	min. ord.	conf.	cat.	prezzo (€)
● 1409025	1/2" M x 1/2" M	NR	1	02		

POSTUMIA TONDA



In ottone

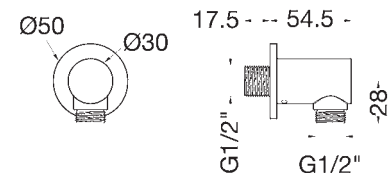

codice	attacchi	UM	min. ord.	conf.	cat.	prezzo (€)
● 1409014	1/2" M x 1/2" M	NR	1	50	02	

POSTUMIA QUADRATA



In ottone

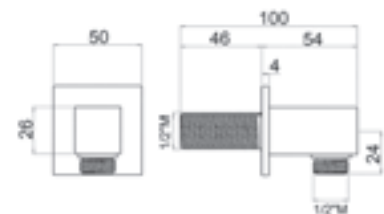

codice	attacchi	UM	min. ord.	conf.	cat.	prezzo (€)
● 1409002	1/2" M x 1/2" M	NR	1	50	02	

CLASSIC



In ottone

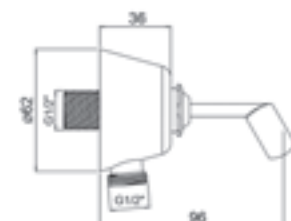

codice	attacchi	UM	min. ord.	conf.	cat.	prezzo (€)
● 1412016	1/2" M x 1/2" M	NR	1	1	02	

LINEA DOCCIA

PRESE ACQUA

PRESA ACQUA TONDA

In ottone.



codice	∅	H (mm)	finitura	UM	min. ord.	conf.	cat.	prezzo (€)
● 1409009	50	26	cromo	NR	1	100	02	
● 1409909	50	26	nero opaco	NR	1	1	02	
● 1409809	50	26	simil acciaio	NR	1	1	02	

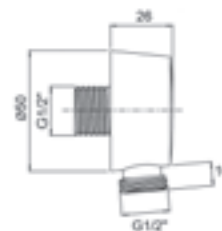

PRESA ACQUA ROSONE

In ottone



codice	∅	UM	min. ord.	conf.	cat.	prezzo (€)
● 2731121	70	NR	1	100	06	
● 2731104	56	NR	1	100	06	

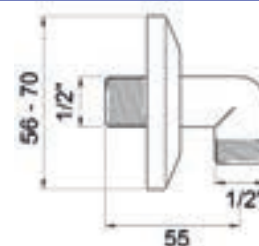

SUPPORTI DOCCIA

SUPPORTO DUPLEX QUADRATO

In ottone, orientabile.



codice	UM	min. ord.	conf.	cat.	prezzo (€)
● 1412004	NR	1	50	02	

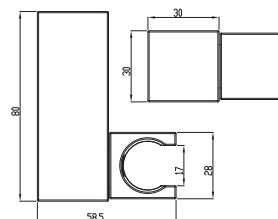

SUPPORTO DUPLEX OVALE

In ottone, fisso.



codice	UM	min. ord.	conf.	cat.	prezzo (€)
● 1412014	NR	1	1	02	

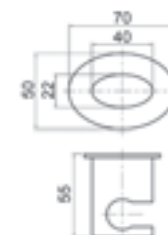

SUPPORTO DUPLEX CLASSIC

In ottone, orientabile.



codice	UM	min. ord.	conf.	cat.	prezzo (€)
● 1412015	NR	1	1	02	

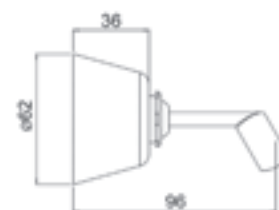

SUPPORTO DUPLEX TONDO



In ABS, orientabile.

codice	UM	min. ord. conf.	cat.	prezzo (€)
● 1412012	NR	1	02	



SUPPORTO DUPLEX QUADRATO



In ABS, orientabile.

codice	UM	min. ord. conf.	cat.	prezzo (€)
● 1412013	NR	1	02	

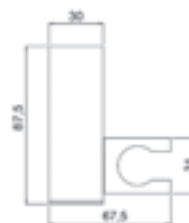

SUPPORTO PIXIE



In ABS, orientabile.

codice	UM	min. ord. conf.	cat.	prezzo (€)
● 1401005	NR	1	02	

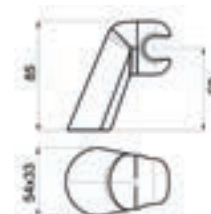

SUPPORTO FIX PER DOCCIA A MURO



In ABS

codice	UM	min. ord. conf.	cat.	prezzo (€)
● 1401004	NR	1	02	

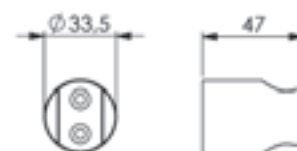

IDROSCOPINI E KIT DOCCETTA

SPRAYJET 2



Idroscopino in ottone con doccetta laser (1401022), flessibile doppia aggraffatura 120 cm. e rubinetto (1401029).

codice	UM	min. ord. conf.	cat.	prezzo (€)
● 1401020	NR	1	02	

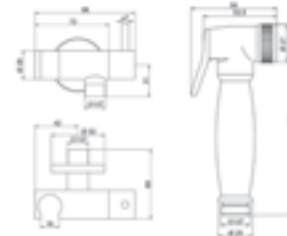

SPRAYJET 1



Idroscopino in ottone con doccetta, flessibile antitorsione da 120 cm., rubinetto (1401012) e supporto.

codice	UM	min. ord. conf.	cat.	prezzo (€)
● 1401009	NR	1	02	

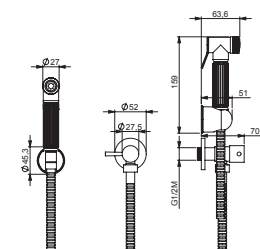

LINEA DOCCIA

IDROSCOPINI E KIT DOCCETTA

SPRAYJET 5



Idroscopino in ABS composto da doccetta (1401019), flessibile antitorzione da 120 cm., con rubinetto d'arresto (1401012) e supporto.

codice	UM	min. ord. conf.	cat.	prezzo (€)
● 1401011	NR	1	02	

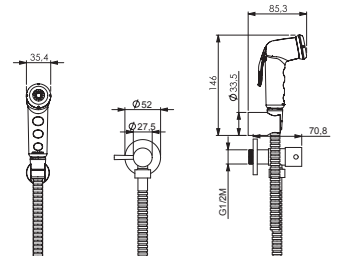

SPRAY 1



Kit doccetta in ABS composto da doccetta (1401019), flessibile antitorzione da 120 cm., supporto cromato.

codice	UM	min. ord. conf.	cat.	prezzo (€)
● 1401010	NR	1	02	

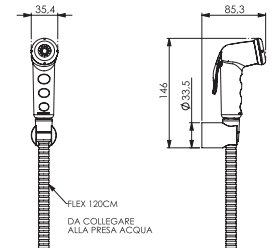

SPRAY 4



Kit doccetta in ABS composto da doccetta bianca (1401024), flessibile bianco da 120 cm., supporto bianco.

codice	UM	min. ord. conf.	cat.	prezzo (€)
● 1401027	NR	1	02	

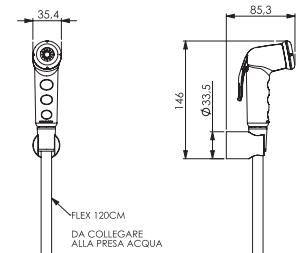

SPRAY 5

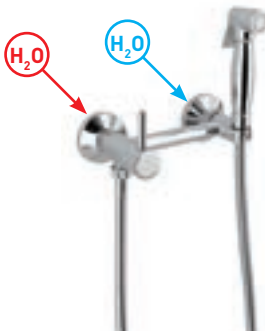

Kit doccetta in ottone composta da doccetta in ottone spray (1401014), flessibile doppia aggraffatura da 120 cm. (1406011) e con miscelatore. Per prevenire il rischio di rottura del flessibile, si raccomanda di chiudere sempre il rubinetto dopo l'uso.

codice	UM	min. ord. conf.	cat.	prezzo (€)
● 1401033	NR	1	02	

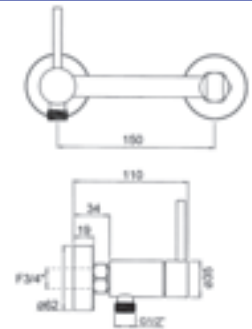

SPRAY 6

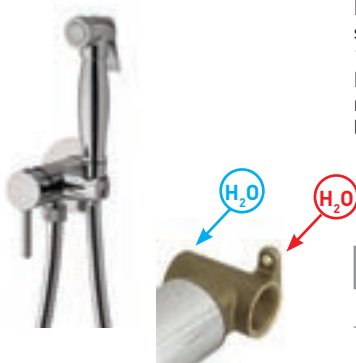

Kit doccetta in ottone composta da doccetta in ottone spray (1401014), flessibile doppia aggraffatura da 120 cm. (1406011) e con miscelatore a incasso. Per prevenire il rischio di rottura del flessibile, si raccomanda di chiudere sempre il rubinetto dopo l'uso.

codice	UM	min. ord. conf.	cat.	prezzo (€)
● 1401034	NR	1	02	

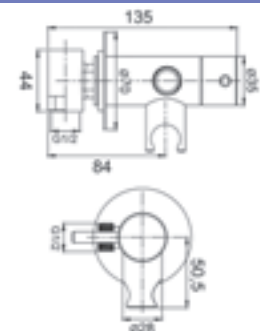

ACCESSORI IDROSCOPINI E KIT DOCCETTA

DOCCETTA LASER OTTONE SPRAYJET 2



codice	UM	min. ord. conf.	cat.	prezzo (€)
● 1401022	NR	1	02	

DOCCETTA OTTONE SPRAY



codice	UM	min. ord. conf.	cat.	prezzo (€)
● 1401014	NR	1	02	

DOCCETTA ABS SPRAY 1 E SPRAYJET 5



codice	UM	min. ord. conf.	cat.	prezzo (€)
● 1401019	NR	1	02	

DOCCETTA ABS SPRAY C/FERMO LEVA



codice	UM	min. ord. conf.	cat.	prezzo (€)
● 1401013	NR	1	02	

DOCCETTA ABS SPRAY 4



codice	UM	min. ord. conf.	cat.	prezzo (€)
● 1401024	NR	1	02	

RUBINETTO STICK C/CHIUSURA PER IDROSCOPINO

Rubinetto per:
Sprayjet 1 (1401009)
Sprayjet 5 (1401011)



codice	UM	min. ord. conf.	cat.	prezzo (€)
● 1401012	NR	1	06	

LINEA DOCCIA

FLESSIBILI DOCCIA

SILVER LUX CONICO F/F

In PVC metallizzato, antitorsione.



codice	lunghezza (cm)	misura	UM	min. ord. conf.	cat.	prezzo (€)
● 1407012	150	1/2"x1/2"	NR	1	15	
● 1407013	200	1/2"x1/2"	NR	1	15	

SILVER CONICO F/F

In PVC, antitorsione.



codice	lunghezza (cm)	misura	UM	min. ord. conf.	cat.	prezzo (€)
● 1407003	150	1/2"x1/2"	NR	1	15	
● 1407006	200	1/2"x1/2"	NR	1	15	

DOPPIA AGGRAFFATURA F/F

In acciaio inox.

Attacchi femmina 1/2"x1/2"



codice	lunghezza (cm)	finitura	UM	min. ord.	conf.	cat.	prezzo (€)
● 1406015	60	cromo	NR	1	1	15	
● 1406011	120	cromo	NR	1	36	15	
● 1406003	150	cromo	NR	1	36	15	
● 1406903	150	nero opaco	NR	1	1	15	
● 1406803	150	simil acciaio	NR	1	1	15	
● 1406004	200	cromo	NR	1	36	15	

DOPPIA AGGRAFFATURA PESANTE F/F

In acciaio antitorsione.



codice	lunghezza (cm)	misura	UM	min. ord. conf.	cat.	prezzo (€)
● 1406023	150	1/2"x1/2"	NR	1	15	
● 1406024	200	1/2"x1/2"	NR	1	15	

GROHE RELEXAFLEX

In PVC cromo, antitorsione.



codice	lunghezza (cm)	misura	UM	min. ord. conf.	cat.	prezzo (€)
● 28151001	150	1/2"x1/2"	NR	1	11	

ACCIAIO RIVESTITO PVC TRASPARENTE

Per alte pressioni, DN8
temperatura Max 70°C
Pressione d'esercizio 10 bar



codice	lunghezza (cm)	misura	UM	min. ord. conf.	cat.	prezzo (€)
● 1407014	120	1/2"x1/2"	NR	1	06	

KIT RIDUTTORE PORTATA 5-7-11 LITRI

Confezione 4 pz.



5 lt/min 7 lt/min 11 lt/min Guarn. 1/2"

codice	UM	min. ord. conf.	cat.	prezzo (€)
● 1401021	NR	1	23	

CURSORE UNIVERSALE

In ABS. Per asta D.18/25 mm.
Si installa senza dover smontare l'asta.



codice	UM	min. ord. conf.	cat.	prezzo (€)
● 1411007	NR	1	02	

CURSORE PER SALISCENDI

In ABS. Per asta D.25,4 mm.



codice	UM	min. ord. conf.	cat.	prezzo (€)
● 1411003	NR	1	02	

PORTASAPONE UNIVERSALE TRASPARENTE

Per asta D.18/21/22/25 mm.



codice	UM	min. ord. conf.	cat.	prezzo (€)
● 1404011	NR	1	02	

CURSORE PER SALISCENDI KELLY

In ABS. Per asta D.25 mm.



codice	UM	min. ord. conf.	cat.	prezzo (€)
● 1411004	NR	1	02	

ATTACCO MISCELATORE CON DEVIATORE

Attacco miscelatore 1/2F"



RICAMBI (PAG. 60)
1406030 - Cartuccia

codice	attacco colonna	UM	min. ord. conf.	cat.	prezzo (€)
● 1414009	1/2"M	NR	1	02	

SUPPORTO INFERIORE COLONNA DOCCIA



codice	attacco colonna	UM	min. ord. conf.	cat.	prezzo (€)
● 1414012	1/2"M	NR	1	02	

ATTACCO SUPERIORE COLONNA DOCCIA



codice	UM	min. ord. conf.	cat.	prezzo (€)
● 1414016	NR	1	02	

CATALOGO
LISTINO N° 6

SANITARI

SANITARI

VETROCHINA E FIRE CLAY	116
AUSILI BAGNO DISABILI	125
SEDILI	137
CASSETTE DI SCARICO	140
LAVATOI	148

VETROCHINA E FIRE CLAY

SERIE GRACE

LAVABO

Installazione sospesa, completo di fissaggi.

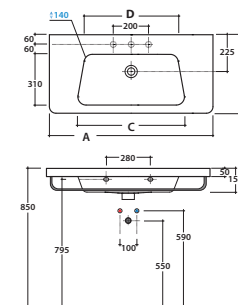

codice	sigla	AxBxCxD [cm]	UM	min. ord.	pz. pallet	cat.	prezzo (€)
3702329	GR100BI	100x48x65x57	NR	1	10	04	
3702330	GR075BI	75x48x49x40	NR	1	12	04	

LAVABO MONOFORO

Installazione sospesa, su colonna o semicolonna.

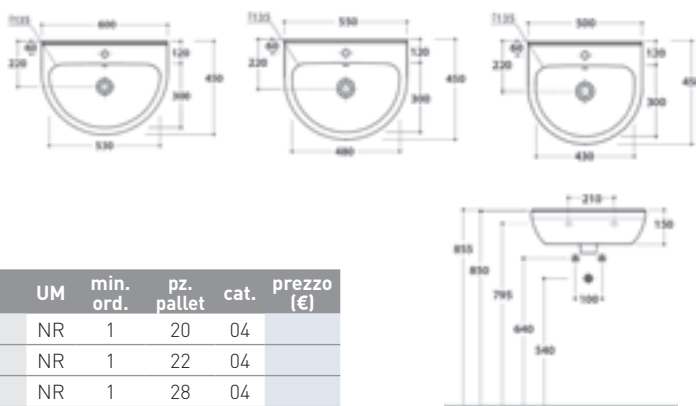

codice	sigla	dimensioni [cm]	UM	min. ord.	pz. pallet	cat.	prezzo (€)
3702332	GRN60BI	60x45	NR	1	20	04	
3702341	GRN55BI	55x45	NR	1	22	04	
3702342	GRN50BI	50x45	NR	1	28	04	

COLONNA

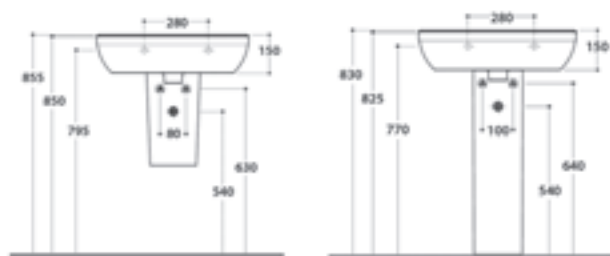

codice	sigla	descrizione	UM	min. ord.	pz. pallet	cat.	prezzo (€)
3702344	GRN05BI	Colonna	NR	1	35	04	
3702343	GRSN5BI	Semicolonna	NR	1	40	04	

LAVABO SOSPESO

Installazione sospesa.

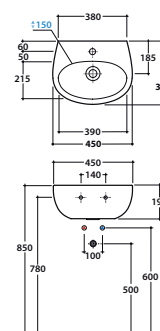

codice	sigla	dimensioni [cm]	UM	min. ord.	pz. pallet	cat.	prezzo (€)
3702305	GR045BI	45x36	NR	1	36	04	

WC SOSPESO SENZA BRIDA



Sedile:
3702321 - 3702334

codice	sigla	descrizione	UM	min. ord.	pz. pallet	cat.	prezzo (€)
3702336	GRS03BI	sospeso	NR	1	18	04	

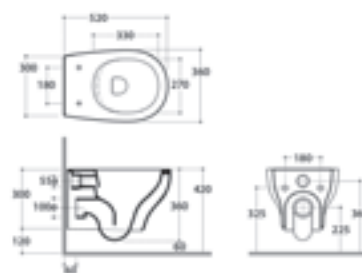

BIDET SOSPESO



codice	sigla	descrizione	UM	min. ord.	pz. pallet	cat.	prezzo (€)
3702337	GRS10BI	sospeso	NR	1	18	04	

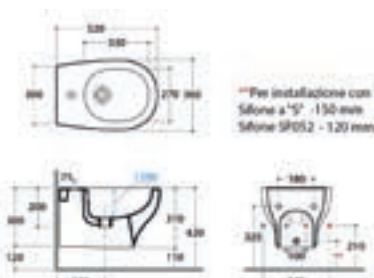

WC MULTI SENZA BRIDA



Sedile:
3702321 - 3702334

codice	sigla	descrizione	UM	min. ord.	pz. pallet	cat.	prezzo (€)
3702338	GR003BI	multi	NR	1	18	04	

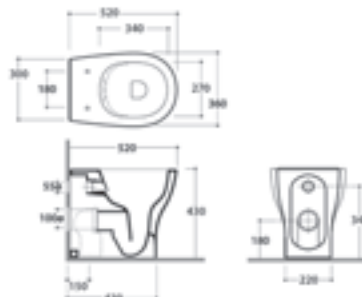

BIDET MULTI



codice	sigla	descrizione	UM	min. ord.	pz. pallet	cat.	prezzo (€)
3702339	GR012BI	bidet	NR	1	18	04	

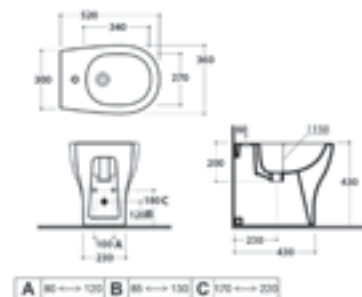

SEDILE TERMOINDURENTE

Removibile con sgancio rapido



codice	sigla	chiusura	UM	min. ord.	pz. pallet	cat.	prezzo (€)
3702321	GR021BI	tradizionale	NR	1	90	04	
3702334	GR022BI	rallentata	NR	1	90	04	

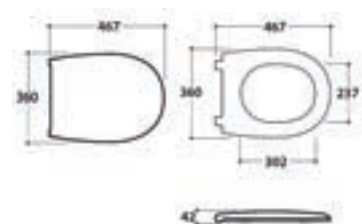

VETROCHINA E FIRE CLAY

CURVE TECNICHE WC E ACCESSORI

CURVA TECNICA REGOLABILE

NOVITÀ!



Con kit di fissaggio

codice	sigla	regolazione (cm)	UM	min. ord.	cat.	prezzo (€)
3702345	VA092	6 - 12	NR	1	09	

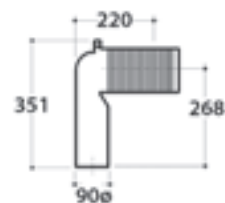

CURVA TECNICA REGOLABILE

NOVITÀ!



Con kit di fissaggio

codice	sigla	regolazione (cm)	UM	min. ord.	cat.	prezzo (€)
3702346	VA093	13 - 16	NR	1	09	

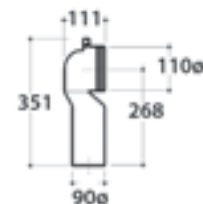

CURVA TECNICA REGOLABILE

NOVITÀ!



Con kit di fissaggio

codice	sigla	regolazione (cm)	UM	min. ord.	cat.	prezzo (€)
3702347	VA094	17 - 21	NR	1	09	

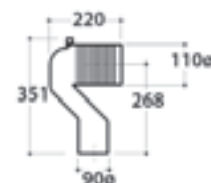

RACCORDO ECCENTRICO

NOVITÀ!



Per entrata acqua h.33 cm o h.36 cm, spostamento 1 cm

codice	sigla	dimensioni	UM	min. ord.	cat.	prezzo (€)
3702348	VA086	Ø 40 x 100	NR	1	09	



RACCORDO A PARETE



codice	sigla	dimensioni	UM	min. ord.	cat.	prezzo (€)
3702325	VA076	Ø 110 x 350	NR	1	09	



RIDUTTORE FLUSSO DI SCARICO



codice	sigla	UM	min. ord.	cat.	prezzo (€)
3702333	VA132	NR	1	09	

LAVABO AD INCASSO



codice	sigla	dimensioni (cm)	UM	min. ord.	pz. pallet	cat.	prezzo (€)
3602040	VA017BI	56,5x48,5x20	NR	1	18	04	

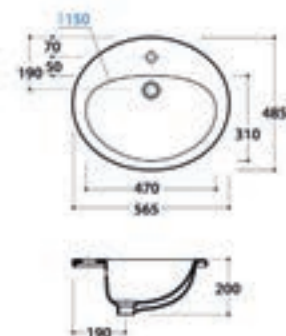

LAVABO SOTTOPIANO



codice	sigla	dimensioni (cm)	UM	min. ord.	pz. pallet	cat.	prezzo (€)
3602060	VA018BI	57x43x20	NR	1	27	04	

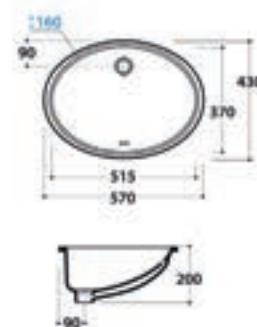

LAVABO SOTTOPIANO



codice	sigla	dimensioni (cm)	UM	min. ord.	pz. pallet	cat.	prezzo (€)
3602062	VA083BI	60x40x20	NR	1	24	04	

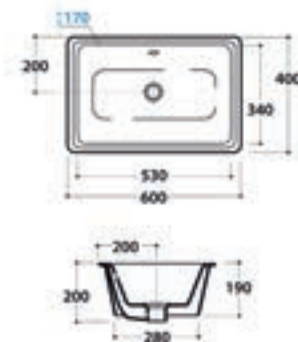

ARTICOLI COMPLEMENTARI

LAVABO AD ANGOLO



codice	sigla	dimensioni (cm)	UM	min. ord.	pz. pallet	cat.	prezzo (€)
3602070	VA020BI	46,5	NR	1	63	03	

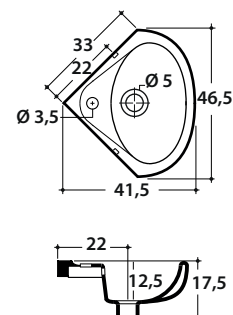

VETROCHINA E FIRE CLAY

ARTICOLI COMPLEMENTARI

PILOZZO

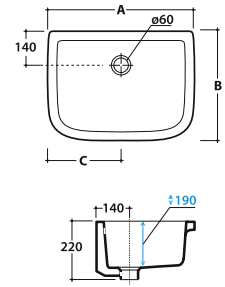

codice	sigla	AxBxC (cm)	UM	min. ord.	pz. pallet	cat.	prezzo (€)
3701601	VA044BI	60x46x30	NR	1	24	03	
3701602	VA043BI	50x40x25	NR	1	30	03	
3701603	VA042BI	44x35x22	NR	1	30	03	

SANITARI

TURCA FILO PAVIMENTO

Morsetto non a corredo

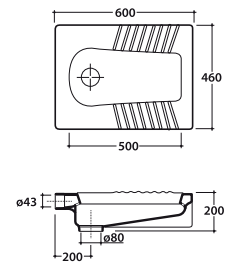

codice	sigla	descrizione	UM	min. ord.	pz. pallet	cat.	prezzo (€)
3701702	VA069BI	Turca	NR	1	28	03	
3702335	VA091	Morsetto	NR	1	1	09	

CASSETTA ALTA

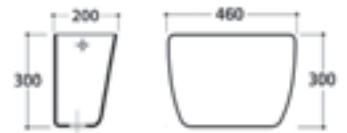

codice	sigla	dimensioni (cm)	UM	min. ord.	pz. pallet	cat.	prezzo (€)
3701703	VA009BI	42x30	NR	1	48	03	

ORINATOIO SOSPESO

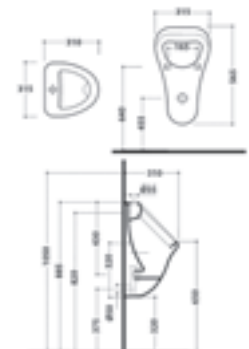

codice	sigla	dimensioni (cm)	UM	min. ord.	pz. pallet	cat.	prezzo (€)
3701704	VA089BI	31,5x31	NR	1	24	03	

CUBE PIATTO DOCCIA H. 4 cm

In ceramica bianca con antiscivolo. Sifone non a corredo.

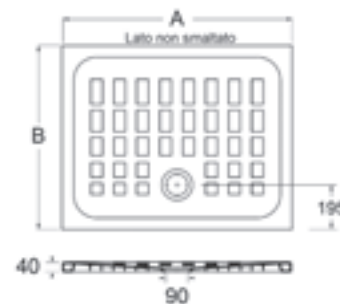

codice	sigla	AxB (cm)	UM	min. ord.	pz. pallet	cat.	prezzo (€)
3519001	CBPD08008040BI	80x80	NR	1	18	03	
3519002	CBPD09009040BI	90x90	NR	1	18	03	
3519003	CBPD09007040BI	90x70	NR	1	18	03	
3519004	CBPD10007040BI	100x70	NR	1	18	03	
3519006	CBPD10008040BI	100x80	NR	1	18	03	
3519005	CBPD12007040BI	120x70	NR	1	18	03	
3519007	CBPD12008040BI	120x80	NR	1	18	03	
3519008	CBPD14007040BI	140x70	NR	1	18	03	
3519009	CBPD14008040BI	140x80	NR	1	18	03	

SIFONE PER CUBE D. 90

Tappo in ABS, completo di curva terminale.

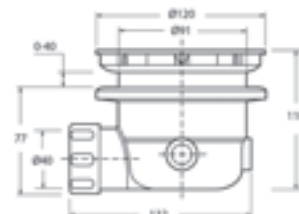

codice	sigla	descrizione	UM	min. ord.	cat.	prezzo (€)
3518050	SIF/FR	CROMATO	NR	1	04	
3518051	SIF/FRC-CT	BIANCO	NR	1	04	

VETROCHINA E FIRE CLAY

PIATTI DOCCIA

FERDY PIATTO DOCCIA QUADRATO H. 6,5 cm.

Sifone non a corredo

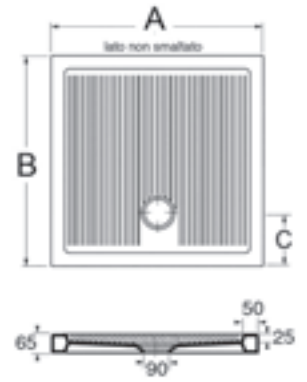

codice	sigla	AxBxC (cm)	UM	min. ord.	pz. pallet	cat.	prezzo (€)
3517001	PFPD07007065BI	70x70x18	NR	1	19	04	
3517002	PFPD08008065BI	80x80x19	NR	1	19	04	
3517003	PFPD09009065BI	90x90x21	NR	1	16	04	

FERDY PIATTO DOCCIA RETTANGOLARE H. 6,5 cm.

Sifone non a corredo

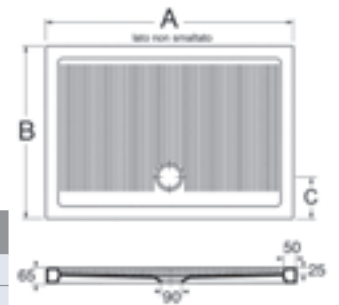

codice	sigla	AxBxC (cm)	UM	min. ord.	pz. pallet	cat.	prezzo (€)
3517004	PFPD09007065BI	90x70x17	NR	1	16	04	
3517005	PFPD10007065BI	100x70x17	NR	1	16	04	
3517006	PFPD12007065BI	120x70x18	NR	1	14	04	
3517007	PFPD14007065BI	140x70x17	NR	1	8	04	
3517008	PFPD10008065BI	100x80x18	NR	1	16	04	
3517009	PFPD12008065BI	120x80x18	NR	1	14	04	
3517010	PFPD14008065BI	140x80x18	NR	1	8	04	

FERDY PIATTO DOCCIA ANGOLARE H. 6,5 cm.

Sifone non a corredo

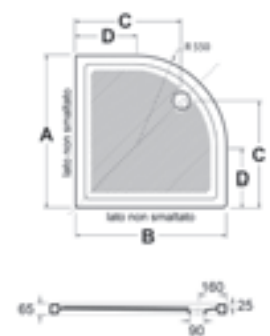

codice	sigla	AxBxCxD (cm)	UM	min. ord.	pz. pallet	cat.	prezzo (€)
3517011	PFPDA9009065BI	90x90x63x35	NR	1	16	04	

TRADIZIONALI PIATTO DOCCIA QUADRATO

Sifone non a corredo



1



2



3

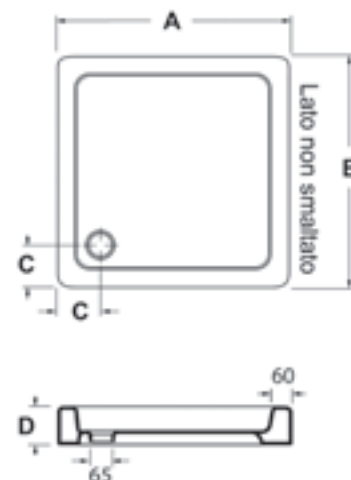

codice	sigla	AxBxCxD (cm)	Foto	UM	min. ord.	pz. pallet	cat.	prezzo (€)
3501011	PCPD07007010BI	70x70x15x10	1	NR	1	13	05	
3501013	PCPD08008010BI	80x80x17x10	2	NR	1	13	05	
*3501016	PCPD09009010BI	90x90x17x11,5	3	NR	1	10	05	

per l'art. 3501016 il "lato non smaltato" è quello A.

TRADIZIONALI PIATTO DOCCIA RETTANGOLARE

Sifone non a corredo



1



2



3

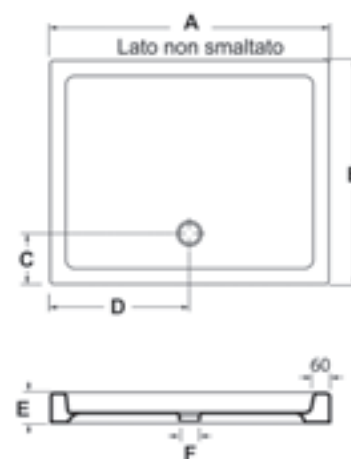

codice	sigla	AxBxCxDxE (cm)	Foro Ø	Foto	UM	min. ord.	pz. pallet	cat.	prezzo (€)
3502020	PCPD08006510BI	80x65x32,5x40x10	55	1	NR	1	13	05	
3502018	PCPD09007210BI	90x72x16x45x10	65	2	NR	1	11	05	
3502013	PCPD10007010BI	100x70x25x50x10	65	3	NR	1	10	05	
3502017	PCPD10008010BI	100x80x25x50x11,5	65	3	NR	1	10	05	
3502015	PCPD12007010BI	120x70x25x60x11,5	65	3	NR	1	8	05	
3502016	PCPD12008010BI	120x80x25x60x11,5	65	3	NR	1	8	05	

VETROCHINA E FIRE CLAY

PIATTI DOCCIA

TRADIZIONALI PIATTO DOCCIA ANGOLARE

Sifone non a corredo

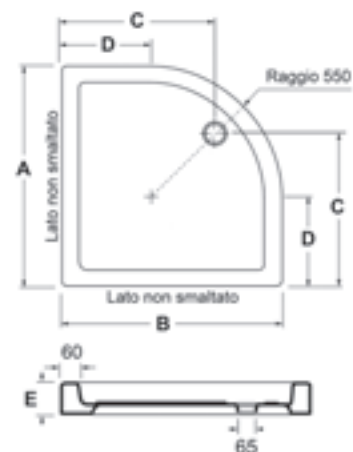

codice	sigla	AxBxCxDxE (cm)	Foro Ø	UM	min. ord.	pz. pallet	cat.	prezzo (€)
3503011	PCPDA8008E10BI	80x80x52x25x11	65	NR	1	12	05	
3503016	PCPDA9009010BI	90x90x63x35x11,5	65	NR	1	10	05	

SANITARI

SIFONE PIATTO DOCCIA CON FORO D.50 E D.60, GRIGLIA OTTONE, RIBASSATO

Griglia D.45 in ottone cromo, sifone e cestello ferma-capelli amovibili, uscita con ghiera. Basso ingombro. Fissaggio con viti



codice	sigla	entrata Ø	uscita Ø	UM	min. ord.	conf.	cat.	prezzo (€)
● 2303009	6461.066.6.	80	1"1/2	NR	1	16	01	

SIFONE PIATTO DOCCIA CON FORO D.50 E D.60, GRIGLIA IN ABS CROMO, RIBASSATO

Griglia coprente D.85 in ABS, sifone e cestello ferma-capelli amovibili, uscita con ghiera. Basso ingombro. Fissaggio con viti



codice	sigla	entrata Ø	uscita Ø	UM	min. ord.	conf.	cat.	prezzo (€)
● 2303010	6461.096.6.	80	1"1/2	NR	1	16	01	

SIFONE PIATTO DOCCIA CON FORO D.90, GRIGLIA IN ABS CROMO, RIBASSATO

Griglia coprente D.118 in ABS, sifone e cestello ferma-capelli amovibili, guarnizione tre lamelle adatta ai piatti doccia in acrilico che quelli in ceramica, uscita con ghiera. Basso ingombro, portata d'acqua maggiorata. Fissaggio con viti

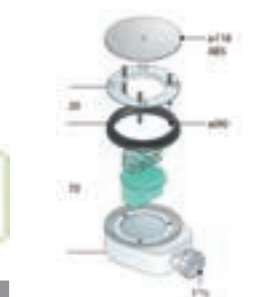

RICAMBI (PAG. 173)
2661106 - Griglia

codice	entrata Ø	uscita Ø	UM	min. ord.	conf.	cat.	prezzo (€)
● 2303007	115	1"1/2	NR	16	01		

SERIE CASUAL+ LAVABO

La Serie Casual+ ha una tonalità di bianco leggermente diversa rispetto alla serie Casual.



Meccanismo inclinazione gas: **4001067**
Kit piastra per pareti leggere: **4001066**

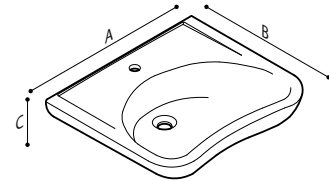

codice	sigla	AxBxC (cm)	UM	min. ord.	conf.	cat.	prezzo (€)
4001052	B40CMS07	64x55,5x17,7	NR	1	6	26	

SERIE CASUAL+ WC APERTURA FRONTALE

La Serie Casual+ ha una tonalità di bianco leggermente diversa rispetto alla serie Casual.



Sedile originale:
4001059-4001065

Sedile non originale:
3203057

codice	sigla	scarico	altezza (cm)	UM	min. ord.	conf.	cat.	prezzo (€)
4001053	B40CB010	pavimento	48,5	NR	1	6	26	
4001054	B40CB011	parete	49	NR	1	6	26	

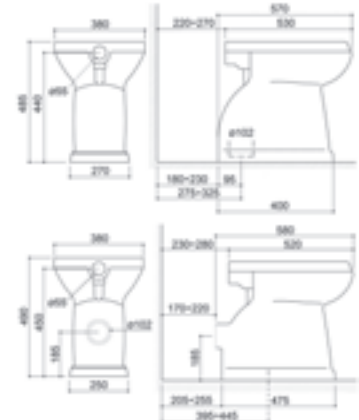

SERIE CASUAL WC



Sedile originale:
4001064

Sedile non originale:
3203058

codice	sigla	scarico	altezza (cm)	UM	min. ord.	conf.	cat.	prezzo (€)
4001061	B40CBC11	pavimento	50	NR	1	6	26	
4001062	B40CBC12	parete	49,5	NR	1	6	26	

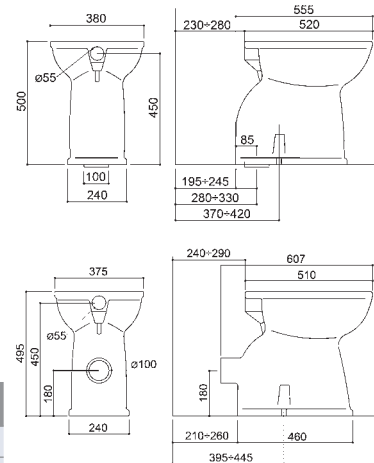

SERIE CASUAL BIDET

Non abbinabile al WC Casual+.



codice	sigla	AxBxC (cm)	altezza (cm)	UM	min. ord.	conf.	cat.	prezzo (€)
4001063	B40CIC11	38x52x50	50	NR	1	6	26	

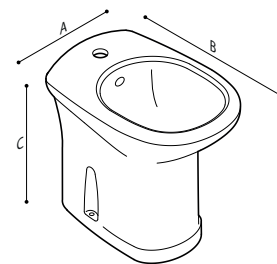

AUSILI BAGNO DISABILI

Serie CASUAL

SERIE CASUAL T WC

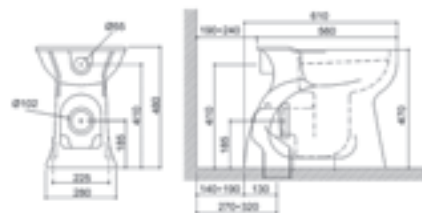

Sedile:
4001071

codice	sigla	scarico	altezza (cm)	UM	min. ord.	conf.	cat.	prezzo (€)
4001069	B40CBC13	pavimento	48	NR	1	6	26	

SANITARI

SERIE CASUAL T BIDET



codice	sigla	AxBxC (cm)	altezza (cm)	UM	min. ord.	conf.	cat.	prezzo (€)
4001070	B40CIC13	36x60,5x47	47	NR	1	6	26	

SEDILE TIPO CASUAL LEGNO CON APERTURA FRONTALE



Per WC:
4001053 - 4001054

codice	materiale	UM	min. ord.	conf.	cat.	prezzo (€)
3203057	legno	NR	1	6	05	

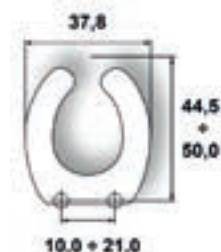

SEDILE TIPO CASUAL LEGNO SENZA APERTURA FRONTALE BIANCO EURO



Per WC:
4001061 - 4001062

codice	materiale	UM	min. ord.	conf.	cat.	prezzo (€)
3203058	legno	NR	1	6	05	

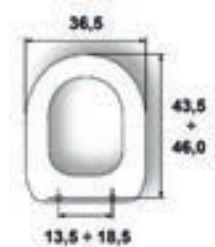

SERIE CASUAL SEDILE LEGNO



Per WC:
4001061 - 4001062

codice	sigla	materiale	UM	min. ord.	conf.	cat.	prezzo (€)
4001064	B41DEC35	legno	NR	1	6	17	

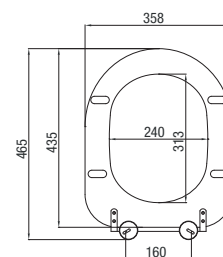

SERIE CASUAL SEDILE TERMOINDURENTE CON APERTURA FRONTALE



Adattabile al WC:
4001053 - 4001054

codice	sigla	materiale	UM	min. ord.	conf.	cat.	prezzo (€)
4001059	B41DE030	termoindurente	NR	1	6	17	

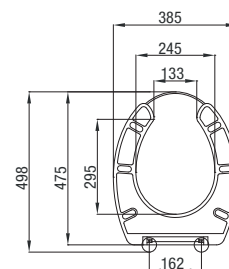

SERIE CASUAL SEDILE POLIPROPILENE CON APERTURA FRONTALE



Per WC:
4001053 - 4001054

codice	sigla	materiale	UM	min. ord.	conf.	cat.	prezzo (€)
4001065	B41DE042	polipropilene	NR	1	3	17	

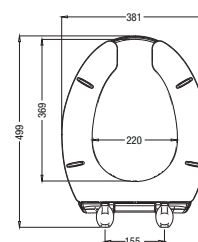

SERIE CASUAL T SEDILE POLIPROPILENE SENZA APERTURA FRONTALE



Per WC:
4001069

codice	sigla	materiale	UM	min. ord.	conf.	cat.	prezzo (€)
4001071	B41DEC26	polipropilene	NR	1	6	17	

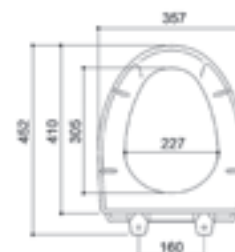

PIATTI DOCCIA

MOD.420 - PIATTO DOCCIA VETRO RESINA FILO PAVIMENTO

Sifone non a corredo



codice	sigla	AxBxC (cm)	UM	min. ord.	conf.	cat.	prezzo (€)
4002004	B40CPS02	80x80x1,5	NR	1	3	13	
4002005	B40CPS01	90x90x1,5	NR	1	3	13	



AUSILI BAGNO DISABILI

ACCESSORI

SPECCHIO RECLINABILE

In vetro di sicurezza

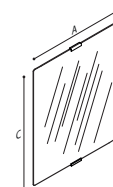

codice	sigla	AxBxC (cm)	UM	min. ord.	conf.	cat.	prezzo (€)
4009011	F41JPS20	44,5x7,3x59,5	NR	1	3	17	

SANITARI

SERIE CASUAL - MECCANISMO INCLINAZIONE GAS



Per lavabo:
4001052

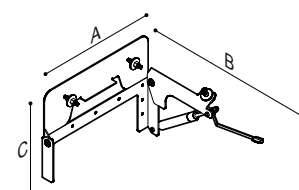

codice	sigla	AxBxC (cm)	UM	min. ord.	conf.	cat.	prezzo (€)
4001067	B41DAS16	53,2x47,9x37,6	NR	1	3	10	

SERIE CASUAL - KIT PIASTRA PER PARETI LEGGERE



Per lavabo:
4001052

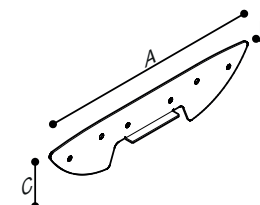

codice	sigla	AxBxC (cm)	UM	min. ord.	conf.	cat.	prezzo (€)
4001066	B41DCS19	58,9x2,4x13,2	NR	1	3	10	

SIFONE A SNODO CON CURVA E ROSONE

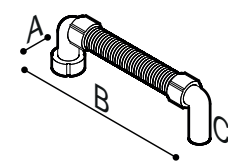

codice	sigla	AxBxC (cm)	UM	min. ord.	conf.	cat.	prezzo (€)
4003002	H51HAS02	5x31,9x10,1	NR	1	3	10	

SIFONE DOCCIA RIBASSATO CON PILETTA

Per piatto doccia in vetroresina.

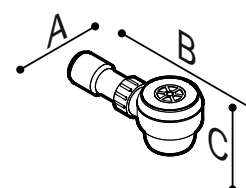

codice	sigla	AxBxC (cm)	UM	min. ord.	conf.	cat.	prezzo (€)
4002003	H52HAS03	9,6x23,3x8,9	NR	1	5	10	

AUSILI BAGNO DISABILI

MANIGLIONI ACCIAIO VERNICIATO

Maniglioni in tubo di acciaio D.32x1,5 mm. verniciato in polvere epossidica, colore bianco caldo.
Piastra a 3 fori in acciaio zincato tropicalizzato spessore 3 mm.
Piastra di livellamento isolante con guarnizione e borchia in nylon - Certificazione TUV

MANIGLIONE LINEARE



codice	A - A1 (cm)	portata max (kg)	UM	min. ord. conf.	cat.	prezzo (€)
● 4101000	30 (inter.22)	150	NR	1	03	
● 4101001	38 (inter.30)	150	NR	1	03	
● 4101002	45 (inter.37)	150	NR	1	03	
● 4101003	53 (inter.45)	150	NR	1	03	
● 4101004	68 (inter.60)	150	NR	1	03	
● 4101005	80 (inter.72)	150	NR	1	03	
● 4101006	98 (inter.90)	150	NR	1	03	
● 4101007	128 (inter.120)	120	NR	1	03	

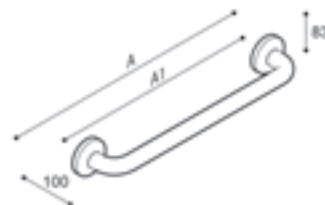

SANITARI

MANIGLIONE ANGOLARE A 135°



codice	portata max (kg)	UM	min. ord. conf.	cat.	prezzo (€)
● 4102001	150	NR	1	03	



BARRA DI SOSTEGNO RIBALTABILE



codice	lunghezza (cm)	portata max (kg)	UM	min. ord. conf.	cat.	prezzo (€)
● 4104001	60	120	NR	1	10	
● 4104002	80	100	NR	1	10	

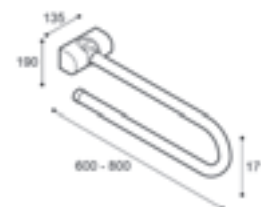

BARRA DI SOSTEGNO RIBALTABILE A PAVIMENTO



codice	portata max (kg)	UM	min. ord. conf.	cat.	prezzo (€)
● 4104004	120 kg in verticale 40 kg in orizzontale	NR	1	03	

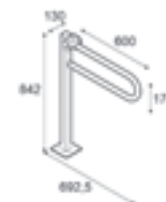

KIT PORTA ROTOLO INSERIBILE PER IMPUGNATURE FISSE E RIBALTABILI



codice	UM	min. ord. conf.	cat.	prezzo (€)
● 4104005	NR	1	03	



AUSILI BAGNO DISABILI

MANIGLIONI ACCIAIO INOX LUCIDO

Maniglioni in tubo acciaio inossidabile AISI 304, D.32x1,5 mm, privo di saldature, finitura lucida. Flangia di fissaggio in acciaio con contro-flangia in poliammide. Copri-flangia in acciaio inox. Portata massima 150 kg.

MANIGLIONE LINEARE INOX



codice	sigla	AxA1 (cm)	UM	min. ord.	conf.	cat.	prezzo (€)
4301001	G29JAS01	35 (inter.27)	NR	1	3	11	
4301002	G29JAS02	45 (inter.37)	NR	1	3	11	
4301003	G29JAS03	55 (inter.47)	NR	1	3	11	
4301004	G29JAS05	70 (inter.62)	NR	1	3	11	
4301005	G29JAS09	120 (inter.112)	NR	1	3	11	

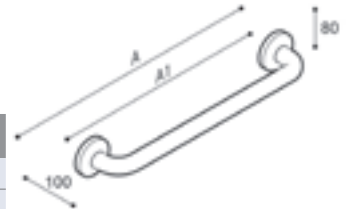

MANIGLIONE ANGOLARE A 135° INOX



codice	sigla	UM	min. ord.	conf.	cat.	prezzo (€)
4301006	G29JAS08	NR	1	3	11	

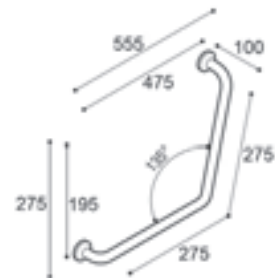

BARRA DI SOSTEGNO RIBALTABILE INOX

Conforme alla norma UNI EN 12182



codice	sigla	lunghezza (cm)	UM	min. ord.	conf.	cat.	prezzo (€)
4301007	G29JCS32	60	NR	1	3	11	
4301008	G29JCS34	80	NR	1	3	11	

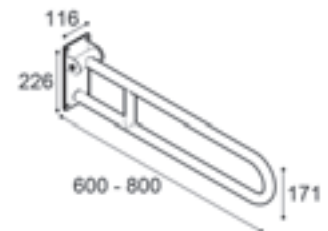

AUSILI BAGNO DISABILI

ALZAWATER

SEDILE ANTICONTATTO SENZA COPERCHIO RIALZATO 10 CM.

Universale termoplastico in resina infrangibile, completo di cerniere in metallo cromato e viti di fissaggio.



codice	UM	min. ord.	conf.	cat.	prezzo (€)
● 3203056	NR	1	3	13	

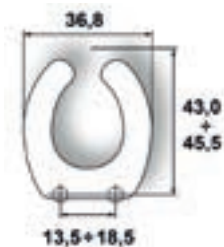

SANITARI

SEDILE ANTICONTATTO CON COPERCHIO RIALZATO 10 CM.

Universale termoplastico in resina infrangibile, completo di doppia cerniera in metallo cromato e viti di fissaggio.



codice	UM	min. ord.	conf.	cat.	prezzo (€)
● 3203059	NR	1	3	13	

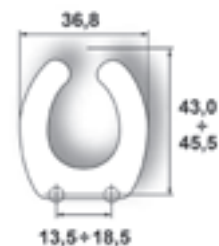

ALZAWATER CON SISTEMA DI BLOCCAGGIO

In polipropilene. Portata max 225 kg.



codice	Altezza (H)	UM	min. ord.	conf.	cat.	prezzo (€)
● 3203060	10 cm	NR	1	42	02	
● 3203063	14 cm	NR	1	2	02	

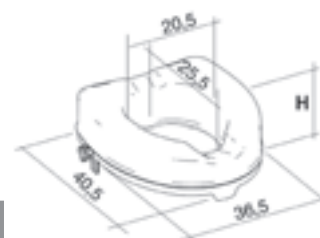

ALZAWATER CON SISTEMA DI BLOCCAGGIO, CON COPERCHIO

In polipropilene. Portata max 225 kg.



codice	Altezza (H)	UM	min. ord.	conf.	cat.	prezzo (€)
● 3203061	10 cm	NR	1	2	02	

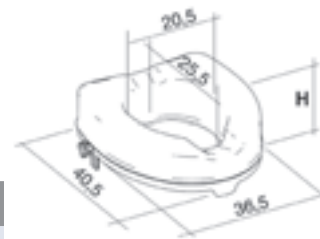

SEGGIOLINO RIBALTABILE PER DOCCIA

In agglomerato, bianco RAL 9010



codice	Portata max (kg)	UM	min. ord. conf.	cat.	prezzo (€)
● 4009023	160	NR	1	03	



SEGGIOLINO RIBALTABILE PER DOCCIA



codice	Portata max (kg)	UM	min. ord. conf.	cat.	prezzo (€)
● 4009007	150	NR	1	03	



SEGGIOLINO RIBALTABILE PER DOCCIA

In polipropilene.



codice	Portata max (kg)	UM	min. ord. conf.	cat.	prezzo (€)
● 4009024	160	NR	1	03	



SEGGIOLINO RIBALTABILE PER DOCCIA CON RINFORZO



codice	Portata max (kg)	UM	min. ord. conf.	cat.	prezzo (€)
● 4009008	150	NR	1	03	

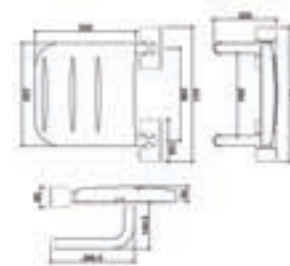

SEGGIOLINO RIBALTABILE PER DOCCIA



codice	Portata max (kg)	UM	min. ord. conf.	cat.	prezzo (€)
● 4009027	125	NR	1	2	03

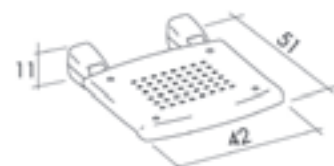

AUSILI BAGNO DISABILI

SEGGIOLINI E SGABELLI

SEGGIOLINO RIBALTABILE PER DOCCIA CON GAMBE



Gambe telescopiche e ribaltabili in alluminio anodizzato. Seduta in tecnopolimero.

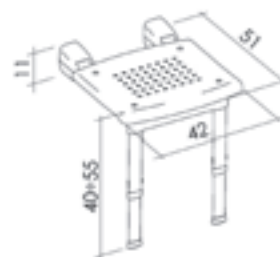

codice	Portata max (kg)	UM	min. ord. conf.	cat.	prezzo (€)
● 4009019	150	NR	1	03	

SEGGIOLINO PER VASCA



Regolabile in larghezza per adattarsi ai diversi tipi di vasche da bagno. La seduta antiscivolo può essere regolata in altezza in 3 diverse posizioni.



codice	Portata max (kg)	UM	min. ord. conf.	cat.	prezzo (€)
● 4009013	165	NR	1	2	02

SEGGIOLINO PER VASCA



Regolabile in larghezza per adattarsi ai diversi tipi di vasca. Struttura in alluminio con terminali in gomma, seduta in tecnopolimeri antiscivolo.

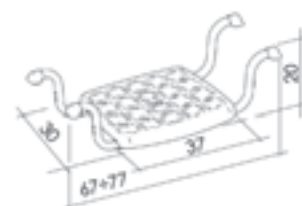

codice	Portata max (kg)	UM	min. ord. conf.	cat.	prezzo (€)
● 4009026	110	NR	1	2	03

SEDIA DA DOCCIA CON SCHIENALE



Gambe telescopiche in alluminio anodizzato, altezza regolabile da 39 a 54 cm. Seduta e schienale in polipropilene.



codice	Portata max (kg)	UM	min. ord. conf.	cat.	prezzo (€)
● 4009017	120	NR	1	2	03

BRACCIOLI PER SEDIA DA DOCCIA



Finitura antiscivolo. Per sedia da doccia (4009017). Il prezzo è riferito alla coppia.

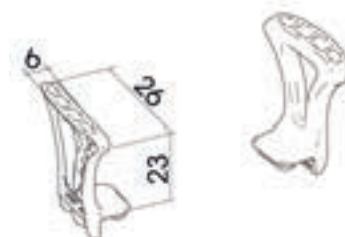

codice	descrizione	UM	min. ord. conf.	cat.	prezzo (€)
● 4009018	accessorio	NR	1	2	03

SGABELLO DA BAGNO

Seduta in polipropilene, gambe in alluminio anodizzato.



codice	Portata max (kg)	UM	min. ord.	conf.	cat.	prezzo (€)
● 4009014	150	NR	1	2	02	

SGABELLO DA BAGNO REGOLABILE

Gambe telescopiche in alluminio anodizzato, altezza regolabile da 40 a 55 cm. Seduta in polipropilene.

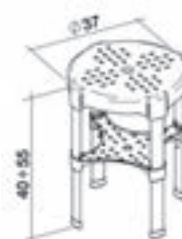

codice	Portata max (kg)	UM	min. ord.	conf.	cat.	prezzo (€)
● 4009015	150	NR	1	2	02	

SGABELLO DA BAGNO REGOLABILE

Gambe telescopiche in alluminio anodizzato, altezza regolabile da 39 a 54 cm. Seduta in polipropilene.

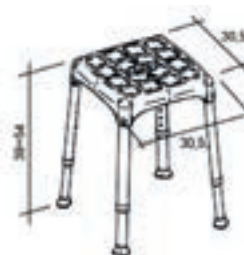

codice	Portata max (kg)	UM	min. ord.	conf.	cat.	prezzo (€)
● 4009016	120	NR	1	2	02	

AUSILI BAGNO DISABILI

VASCHE IN VETRORESINA

MOD. 656 - VASCA



Vasca con porta ad apertura verso l'interno. Completa di miscelatore con deviatore, pannello frontale, pannello laterale sinistro e colonna di scarico.

Fornita con tutte le componenti assemblate, dotata di piedini regolabili in altezza con escursione 45 mm.

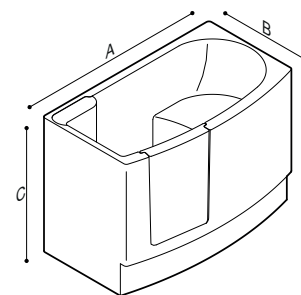

codice	sigla	AxBxC (cm)	UM	min. ord.	cat.	prezzo (€)
4009913	M74MDS21	126,5x70x93	NR	1	12	

MOD. 654 - VASCA



Vasca con porta ad apertura verso l'interno. Completa di miscelatore con deviatore, pannello frontale, pannello laterale destro e colonna di scarico. (Maniglia sul corpo, vasca non compresa).

Fornita con tutte le componenti assemblate, dotata di piedini regolabili in altezza con escursione 45 mm.

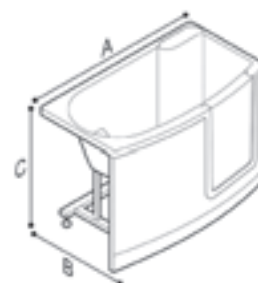

codice	sigla	AxBxC (cm)	UM	min. ord.	cat.	prezzo (€)
4009901	M74MDS14	130x75x92	NR	1	12	

MOD. 653/1 - VASCA



Vasca con porta ad apertura verso l'interno, munita di maniglia di sostegno. Fornita con rubinetteria. Completa di pannello frontale, pannelli laterali e colonna di scarico.

Fornita con tutte le componenti assemblate, dotata di piedini regolabili in altezza con escursione 45 mm.

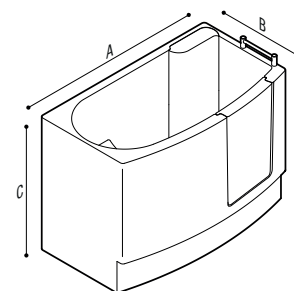

codice	sigla	AxBxC (cm)	UM	min. ord.	cat.	prezzo (€)
4009907	M74MDS12	130x75x92	NR	1	12	

MOD. 652 - VASCA



Vasca con porta ad apertura verso l'esterno, munita di maniglia sul corpo vasca. Leva d'apertura sulla porta. Con miscelatore. La vasca viene fornita pannellata su tutti i lati.

Fornita con tutte le componenti assemblate, dotata di piedini regolabili in altezza con escursione 45 mm.

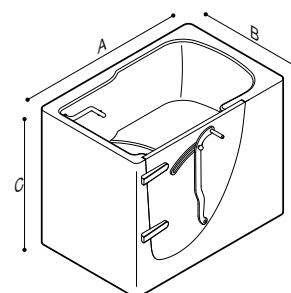

codice	sigla	AxBxC (cm)	UM	min. ord.	cat.	prezzo (€)
4009906	M74MDS07	115x78x93	NR	1	12	

SEDILE LEGNO MODELLO UNIVERSALE BIANCO EUROPEO



Anima in legno rivestito in poliestere, completo di viti di fissaggio.

RICAMBI (PAG. 139)
3203092 - Cerniere

codice	cerniere	peso (kg)	UM	min. ord. conf.	cat.	prezzo (€)
● 3203054	cromate	3,20	NR	6	05	

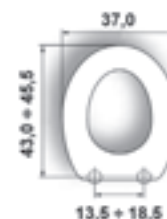

ADATTABILITÀ

MODELLO	CASA CERAMICA
AIRONE	TENAX
ALEXANDRA	CESABO
ALFA	SIMAS
AMALFI	HATRIA - SPEA
ANTARES	ALTHEA (EX SANITALIA)
ARCOBALENO	POZZI GINORI
ARENA	FLAMINIA
AURA	POZZI GINORI
AURORA	POZZI GINORI
AVENTINO	ISVEA
BAIA	HATRIA - SPEA
BALZANA	SENESI
BETA	SIMAS
BRAVA	VINCENTI
BRUNELLO	SENESI
CALYPSO	VITRUVIT
CANNES	HATRIA - SPEA
CARAVAGGIO	DELTA
CIMINO	EOS (EX SIMCA)
CONCHIGLIA	ETRURIA
DELTA	DELTA
DERBY	GRAVENA
DERBY	HATRIA - SPEA
DORICA	CESAME
ELITE	CESABO
EUROPA	POZZI GINORI
FARNESE	VAVID
FAUSTA	SBORDONI
FLAMINIA	SBORDONI
FRENTANA	GRAVENA
FRIULI	IDEAL STANDARD (EX SCALA)
GAIA	FALERI

MODELLO	CASA CERAMICA
GARDENA	POZZI GINORI
GIOIA	DELTA
GOLIA	JUMBO
HOLA	ALTHEA (EX SANITALIA)
IMPERO	ASTRA
IRIS	MICAS
ISEO	ALFA
ISEO	G.S.I. DIVISIONE FACIS
ISEO MONOB.	ALFA
ITACA	ILCA
JUBILEUM	AZZURRA
LADY	VITRUVIT
LAGO MONOBL.	DOLOMITE
LEI NEW	GLOBO
LEI NEW MONOB.	GLOBO
LEONESSA	CIERRE SANITARI
LONGA	IDEAL STANDARD (EX SCALA)
LUGANO	G.S.I. DIVISIONE FACIS
MAIORCA	EUROPA
MENFI	ILCA
MICENE	ILCA
MICHELANGELO	SENESI
MILANO	VINCENTI
MINERVA	VITRUVIT
MIRTO	AXA
MONACO	HATRIA - SPEA
MONTEZUMA	SIMAS
NIZZA	HATRIA - SPEA
NOEMI	JUMBO
NORI	FLAMINIA
NOVELLA	FALERI
OMEGA	JUMBO

MODELLO	CASA CERAMICA
OPI	INCEA
ORCHIDEA	EOS (EX SIMCA)
PARTENONE	VITRUVIT
PARTENOPEA	VAVID
PEGASO	TENAX
PIEMONTESINA DUO	POZZI GINORI
PIU'	MICAS
POMPEA	INCEA
POMPEI	FLAMINIA
PONTI	IDEAL STANDARD
PONTI ZETA 3164	IDEAL STANDARD
PRIMAVERA	IDEAL STANDARD (EX SCALA)
RECORD	HIDRA
ROMA	HIDRA
RUGIADA	IDEAL STANDARD (EX SCALA)
SABRINA	FALERI
SAMBA	DELTA
SELVA	POZZI GINORI
SILA	CESAME
SIMPLEX	CESAME
SIRIO	ETRURIA
SKY	ALTHEA (EX SANITALIA)
TABOR	POZZI GINORI
TAORMINA	CESAME
TOPAZIO	G.S.I. DIVISIONE VENUS
TORCELLO	POZZI GINORI
TRIS	GRAVENA
TUA	IDEAL STANDARD (EX SCALA)
VEGA	TENAX
VERA	GALASSIA
VIENNA	EUROPA

SEDILI

SEDILI UNIVERSALI E ADATTABILI

TESI BIANCO EURO

NOVITÀ!



Anima in legno rivestito in poliestere, completo di viti di fissaggio

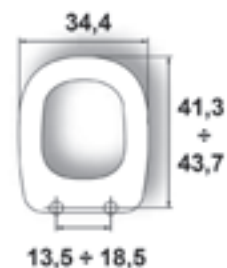

RICAMBI (PAG. 139)
3203092 - Cerniere

codice	sigla	cerniere	peso (kg)	UM	min. ord.	conf.	cat.	prezzo (€)
● 3203033	M0200A1/01	cromate	3,0	NR	1	6	05	

ADATTABILITÀ

MODELLO	CASA CERAMICA
CURVA	VINCENTI
NUBE	INCEA
NUBE MONO	INCEA
ORIENT	RAK CERAMICS
PIENZA	SENESI
TESI	IDEAL STANDARD
TESI NEW SOSPESO	IDEAL STANDARD

SANITARI

CONCA BIANCO EURO

NOVITÀ!



Anima in legno rivestito in poliestere, completo di viti di fissaggio

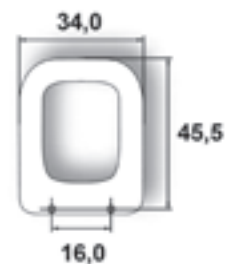

codice	sigla	cerniere	peso (kg)	UM	min. ord.	conf.	cat.	prezzo (€)
● 3203034	M0500F2/01	cromate	3,0	NR	1	6	05	

ADATTABILITÀ

MODELLO	CASA CERAMICA
C-0	ISVEA
CONCA	IDEAL STANDARD
CONNY	GRAVENA
CORTINA	CIERRE SANITARI
DUCCIO	SENESI
MAXI JOLLY	SCIC
MEDINA	FALERI
PRESTIGE	CESABO
SVEDA	ALTHEA (ex Sanitalia)
VERSILIA	VINCENTI

SEDILI UNIVERSALI E ADATTABILI

K2 EVO



Universale, avvolgente, termoplastico in resina infrangibile.

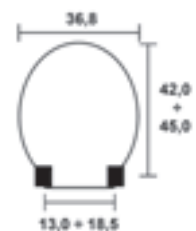

codice	sigla	cerniere	peso (kg)	UM	min. ord.	conf.	cat.	prezzo (€)
● 3203051	1109	plastica	1,20	NR	1	9	06	

DENVER (EX CANYON)



In farina di legno e resina termoindurente formate in stampo.

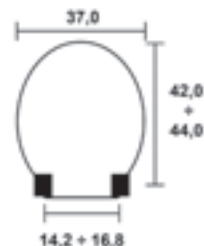

codice	sigla	cerniere	peso (kg)	UM	min. ord.	conf.	cat.	prezzo (€)
● 3202002	5050TP000	plastica	2,90	NR	6	04		

BUXTON (EX S12 SPA)



In materiale termoplastico, interamente riciclabile.

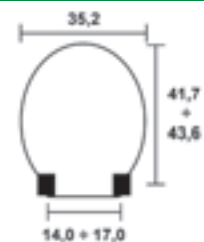

codice	sigla	cerniere	peso (kg)	UM	min. ord.	conf.	cat.	prezzo (€)
● 3203007	2850TP000	plastica	1,66	NR	6	04		

NEW YORK (EX DANUBIO STA-TITE)



In farina di legno, con sistema di fissaggio che non si allenta mai (ULTRA-FIX).

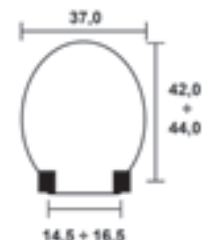

codice	sigla	cerniere	peso (kg)	UM	min. ord.	conf.	cat.	prezzo (€)
● 3202001	4100CPT000	cromate	3,30	NR	6	04		

STAR



In resina termoindurente, antigraffio.
Cerniere inox regolabili, funzione sgancio rapido.

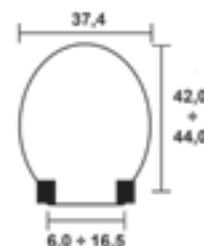

codice	cerniere	peso (kg)	UM	min. ord.	conf.	cat.	prezzo (€)
● 3203067	inox	2,76	NR	5	03		

RICAMBI

KIT CERNIERA



Compatibilità
3203054 - Universale
3203033 - Tesi

codice	sigla	UM	min. ord.	conf.	cat.	prezzo (€)
● 3203092	CWCA01	NR	1	1	05	

CASSETTE DI SCARICO

CASSETTE ESTERNE

Scocca in ABS con trattamento anti invecchiamento. Coibentazione anticondensa ed insonorizzante. Galleggiante a scatola da 3/8" compatto, rapido e silenzioso.

TURBINE 2



Installazione a zaino o media altezza, capacità 9 lt con doppio tasto per scarico parziale da 3 a 4,5 lt. Completa di rubinetto per allacciamento idrico destro, sinistro o centrale posteriore.

RICAMBI (PAG. 146)

3302117 - Meccanismo completo

3302119 - Gruppo ponte con leve

codice	UM	min. ord. conf.	cat.	prezzo (€)
● 3301001	NR	5	01	

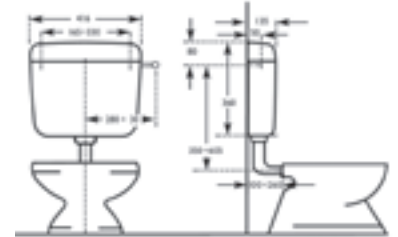

SANITARI

NETTUNO 1



Ultrapiatte, installazione a zaino o media altezza, capacità 7 lt con un tasto start/stop. Completa di rubinetto per allacciamento idrico destro, sinistro o centrale posteriore.

RICAMBI (PAG. 146)

3302126 - Meccanismo completo

3302127 - Coperchio completo con leva

codice	UM	min. ord. conf.	cat.	prezzo (€)
● 3301051	NR	5	01	

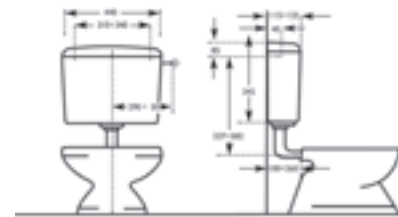

TURBINE CON PREDISPOSIZIONE PNEUMATICA



Predisposta per comando pneumatico a scelta, installazione alta o a zaino, adatta a bagni per disabili. Capacità 9 lt, completa di rubinetto per allacciamento idrico destro, sinistro o centrale posteriore.

ACCESSORI E RICAMBI (PAG. 142-146)

3302301 - Pulsante esterno

3302302 - Pulsante incasso

3302128 - Meccanismo completo

codice	sigla	UM	min. ord. conf.	cat.	prezzo (€)
● 3301012	1000C1/07	NR	1	5	01

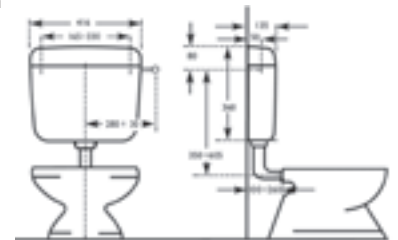

ALFA ALTA



Installazione in posizione alta, capacità 9 lt con comando a leva con cordella. Completa di rubinetto per allacciamento idrico destro o sinistro.

codice	sigla	descrizione	UM	min. ord. conf.	cat.	prezzo (€)
● 3301032	1041S	con coperchio	NR	1	02	

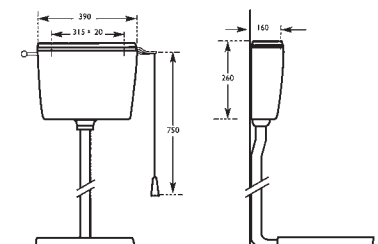

ANGOLO



Installazione a zaino in angolo, capacità 9 lt con un tasto start/stop. Possibilità di allacciamento idrico destro o sinistro.

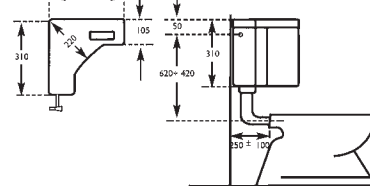

codice	sigla	descrizione	UM	min. ord. conf.	cat.	prezzo (€)
● 3301041	1051	con rubinetto	NR	1	02	

SLIM



Superpiatta. Installazione a zaino, capacità 9 litri con tasto start/stop. Coibentazione anticondensa. Completa di rubinetto per allacciamento destro o sinistro o centrale posteriore.

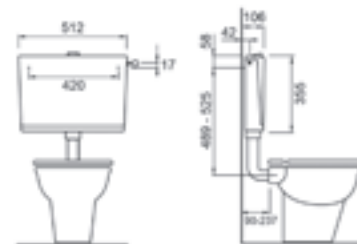

RICAMBI (PAG. 146)
3302129 - Meccanismo completo

codice	UM	min. ord.	conf.	cat.	prezzo (€)
● 3301080	NR	1	28	02	

GROHE CASSETTA ESTERNA DALLUX



Installazione a zaino, capacità 9 lt. con tasto start/stop. Completa di rubinetto per allacciamento idrico destro, sinistro o centrale posteriore.

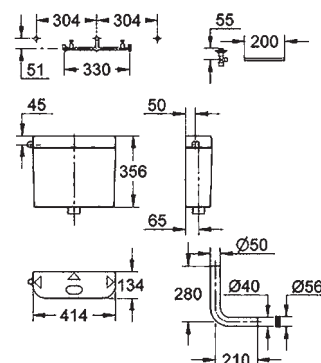

RICAMBI (PAG. 146-147)
37092000 - Valvola carico
43486000 - Valvola scarico
43544000 - Pistone

codice	UM	min. ord.	conf.	cat.	prezzo (€)
● 38372SH0	NR	1	40	17	

CASSETTE INCASSO

GROHE CASSETTA INCASSO spessore mm. 80



Senza piastra di azionamento.

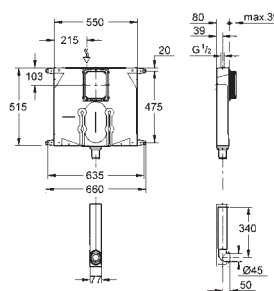

codice	UM	min. ord.	conf.	cat.	prezzo (€)
● 38863000	NR	1	40	17	

CASSETTE DI SCARICO

CASSETTE INCASSO

GROHE UNISSET TELAIO CON CASSETTA PER WC SOSPESO



Senza piastra di azionamento.

codice	UM	min. ord.	conf.	cat.	prezzo (€)
● 38729000	NR	1	10	17	

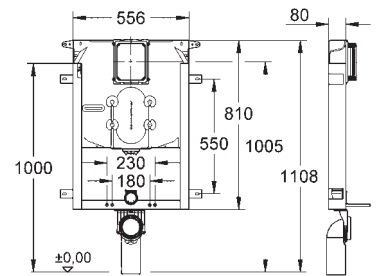

STAFFA BIDET SOSPESO MOD. COMBI



Compreso raccorderia di fissaggio.

codice	interasse (mm)	UM	min. ord. conf.	cat.	prezzo (€)
● 5850031	180-230	NR	1	09	

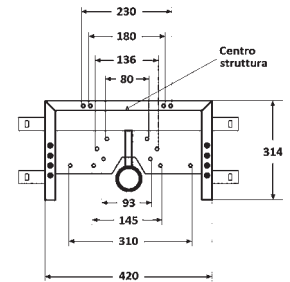

ACCESSORI E RICAMBI CASSETTE

GROHE PIASTRA SKATE COSMO



codice	descrizione	UM	min. ord. conf.	cat.	prezzo (€)
● 38732SH0	bianca	NR	1	11	
● 38732000	cromo	NR	1	11	

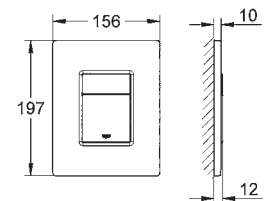

GROHE PIASTRA PER CASSETTA 37594



codice	descrizione	UM	min. ord. conf.	cat.	prezzo (€)
● 37859SH0	bianca	NR	1	10	

GROHE PIASTRA AZIONAMENTO PER CASSETTA 37051

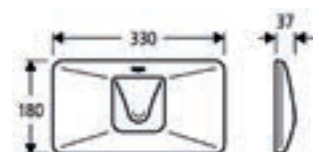

codice	descrizione	UM	min. ord. conf.	cat.	prezzo (€)
● 37054SH0	bianca	NR	1	10	

PULSANTE ESTERNO BIANCO

Completo di tubetto e canalina.



codice	sigla	UM	min. ord. conf.	cat.	prezzo (€)
● 3302301	PE	NR	1	06	

PULSANTE INCASSO BIANCO

Completo di tubetto e guaina.



codice	sigla	UM	min. ord. conf.	cat.	prezzo (€)
● 3302302	PI	NR	1	06	

RUBINETTO GALLEGGIANTE MAGNETIC UNIVERSALE

Galleggiante insonorizzato conforme DIN 4109 a funzionamento magnetico, con regolazione livello acqua, vite di regolazione reversibile, filtro anti impurità. Funzionamento da 0,4 a 10 bar.

APPLICAZIONI: per cassette incasso di nuova generazione e per cassette esterne in plastica e ceramica.

DOTAZIONE: codolo ottone 3/8" nichelato di 40 mm.; codolo 3/8" plastica di 30 mm.; dado e rondella plastica da 3/8"



codice	sigla	UM	min. ord. conf.	cat.	prezzo (€)
● 3302010	CMAGNCER	NR	25	01	

RUBINETTO GALLEGGIANTE MAGIK INCASSO

Per qualsiasi tipo e marca di cassetta wc, sia incasso che esterna.

Galleggiante insonorizzato conforme DIN 4109 a funzionamento magnetico, con regolazione livello acqua, filtro anti impurità, distanziale anticollisione

Funzionamento da 0,2 a 10 bar.



codice	sigla	UM	min. ord. conf.	cat.	prezzo (€)
● 3302016	CMAGIK00	NR	1 25	01	

RUBINETTO GALLEGGIANTE FLUIDMASTER ATTACCO LATERALE

Con **codolo in ottone**. Per qualsiasi tipo e marca di cassetta wc, sia incasso che esterna o a zaino. Adatto anche per le cassette ultrapiatte. Silenzioso, compatto, resistente alla corrosione con filtro anti impurità. Chiusura istantanea del flusso a livello desiderato, con regolazione semplice e invariabile con la pressione.

Adattatore universale incluso.



codice	sigla	UM	min. ord. conf.	cat.	prezzo (€)
● 3302006	747E-036-P20	NR	20	15	

RUBINETTO GALLEGGIANTE CONTROPRESSIONE NANOTEK

Universale per cassette esterne e incasso.

Fornito con due adattatori che permettono di installare il galleggiante su cassette di altri produttori.

Dotato di silenziatore acustico per ridurre l'impatto sonoro, filtro anti-impurità ispezionabile.



codice	sigla	UM	min. ord. conf.	cat.	prezzo (€)
● 3302017	1513IT	NR	1 14	15	

RUBINETTO GALLEGGIANTE FLUIDMASTER ATTACCO DAL BASSO

Con **codolo in ottone**. Per qualsiasi tipo e marca di cassetta wc esterna ed in ceramica, con attacco alla rete idrica in basso. Silenzioso, compatto, resistente alla corrosione, con filtro anti impurità. Regolazione telescopica dell'altezza. Chiusura istantanea del flusso a livello desiderato, con regolazione semplice e invariabile con la pressione.



codice	sigla	UM	min. ord. conf.	cat.	prezzo (€)
● 3302007	400E-025-P25	NR	1 25	15	

BATTERIA A CAVO

Batteria a cavo 2 scarichi, per cassette in ceramica.

Pulsante compatibile con fori D. 40 e D. 20



codice	sigla	UM	min. ord. conf.	cat.	prezzo (€)
● 3302411	1402CSG	NR	1	06	

BATTERIA PNEUMATICA

Batteria pneumatica 1 scarico, per cassette in ceramica.

Pulsante compatibile con fori D. 40 e D. 20



codice	sigla	UM	min. ord. conf.	cat.	prezzo (€)
● 3302410	1402ASG	NR	1	06	

CASSETTE DI SCARICO

ACCESSORI E RICAMBI CASSETTE

TUBO SCARICO CASSETTA ZAINO 600X220 mm

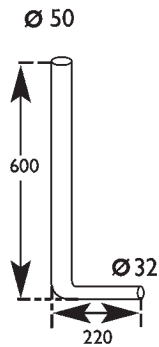

codice	sigla	UM	min. ord.	conf.	cat.	prezzo (€)
● 3302106	1502	NR	1	10	06	

TUBO SCARICO CASSETTA ZAINO 1000X220 mm



codice	sigla	UM	min. ord.	conf.	cat.	prezzo (€)
● 3302103	1503	NR	1	18	06	

TUBO SCARICO CASSETTA ZAINO 1100 x 280 mm REGOLABILE

Due pezzi.
Completo di manicotto e
fissaggi

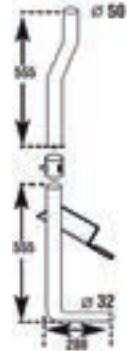

codice	sigla	uscita Ø	UM	min. ord.	conf.	cat.	prezzo (€)
● 3302104	1503A	32	NR	1	20	06	

TUBO SCARICO CASSETTA ZAINO 800 x 260 mm

Sagomato

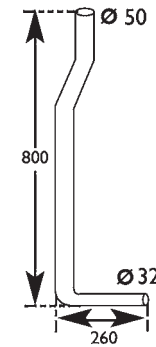

codice	sigla	UM	min. ord.	conf.	cat.	prezzo (€)
● 3302107	1508	NR	1	20	06	

TUBO SCARICO CASSETTA ALTA

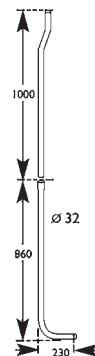

codice	sigla	UM	min. ord.	conf.	cat.	prezzo (€)
● 3302101	1500A	NR	1	15	06	

KIT TUBO SCARICO CASSETTA ALTA, CROMATO

Tubo componibile 3
pezzi D.30 mm, in ottone
cromato. Compreso kit di
fissaggio



codice	UM	min. ord. conf.	cat.	prezzo (€)
● 3302112	NR	1	06	

TUBO DI SCARICO CASSETTA ZAINO

620x330 mm
con morsetto D.50x44

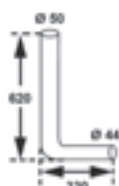

codice	sigla	UM	min. ord. conf.	cat.	prezzo (€)
● 3302108	1501BLACC	NR	1	06	

SPANDIACQUA UNIVERSALE PER TURCA

Per tubo D.32 mm



codice	sigla	UM	min. ord. conf.	cat.	prezzo (€)
● 3302109	1519	NR	1	06	

CANOTTO TELESCOPICO

Completo di rosone e morsetto per wc.



codice	UM	min. ord.	conf.	cat.	prezzo (€)
● 3302205	NR	1	50	06	

CANOTTO DRITTO

Completo di rosone e morsetto per wc



codice	sigla	UM	min. ord.	conf.	cat.	prezzo (€)
● 3302204	2178.307.6.	NR	1	30	06	

CANOTTO ECCENTRICO

Completo di rosone e morsetto per wc



codice	sigla	UM	min. ord. conf.	cat.	prezzo (€)
● 3302203	1506B	NR	1	06	

GROHE CANOTTO PER CASSETTA



codice	UM	min. ord.	conf.	cat.	prezzo (€)
● 37103SH0	NR	1	40	10	

CURVETTA IN RAME PER GALLEGGIANTI

Tubo D. 10 mm, raccordi da 3/8" con guarnizioni. Per adattare i galleggianti ai diversi tipi di cassette ad incasso.



codice	sigla	UM	min. ord. conf.	cat.	prezzo (€)
● 3302013	BG091600	NR	1	06	

RUBINETTO MASCHIO PER CASSETTA WC

Chiusura a vitone con codolo e calotta girevole



codice	sigla	attacco Ø	UM	min. ord.	conf.	cat.	prezzo (€)
● 2733002	0500C300CR	3/8"x3/8"	NR	1	50	06	
● 2733001	0500C400CR	1/2"x3/8"	NR	1	50	06	

RUBINETTO FEMMINA PER CASSETTA WC

Chiusura a vitone con codolo e calotta girevole



codice	sigla	attacco Ø	UM	min. ord.	conf.	cat.	prezzo (€)
● 2733000	0509C300CR	3/8"x3/8"	NR	1	50	06	

RUBINETTO MASCHIO PER CASSETTA WC CON TUBO

Chiusura a vitone con tubetto in rame cromato D.10



codice	sigla	attacco Ø	UM	min. ord.	conf.	cat.	prezzo (€)
● 2733003	05050300CR	3/8"x3/8"	NR	1	25	06	
● 2733004	05050400CR	1/2"x3/8"	NR	1	25	06	

RUBINETTO MASCHIO PER CASSETTA WC CON TUBI

Chiusura a vitone, con tubetti in rame cromato D.10 lunghi 15 cm



codice	sigla	attacco Ø	UM	min. ord.	conf.	cat.	prezzo (€)
● 2733005	05070300CR	3/8"x3/8"	NR	1	20	06	

CASSETTE DI SCARICO

ACCESSORI E RICAMBI CASSETTE

TURBINE 2 MECCANISMO COMPLETO



codice	sigla	UM	min. ord. conf.	cat.	prezzo (€)
● 3302117	1400C	NR	1	06	

TURBINE 2 GRUPPO PONTE CON LEVE



codice	sigla	UM	min. ord. conf.	cat.	prezzo (€)
● 3302119	1531R4	NR	1	06	

NETTUNO 1 MECCANISMO COMPLETO



codice	sigla	UM	min. ord. conf.	cat.	prezzo (€)
● 3302126	1400B	NR	1	06	

TURBINE 1 GRUPPO PONTE CON LEVE



codice	sigla	UM	min. ord. conf.	cat.	prezzo (€)
● 3302128	1531R3	NR	1	06	

NETTUNO 1 COPERCHIO COMPLETO C/LEVA



codice	sigla	UM	min. ord. conf.	cat.	prezzo (€)
● 3302127	1087S/DELO	NR	1	06	

GUARNIZIONE DI TENUTA MECCANISMO DI SCARICO

Confezione da 10 Pz.

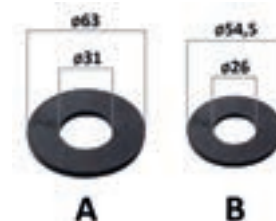

codice	sigla	modello	UM	min. ord. conf.	cat.	prezzo (€)
● 3302201	1540-10	A	CF	1	06	
● 3302202	1540V-10	B	CF	1	06	

SLIM MECCANISMO COMPLETO



codice	UM	min. ord. conf.	cat.	prezzo (€)	
● 3302129	NR	1	1	02	

RICAMBI GROHE

VALVOLA CARICO UNIVERSALE DA 3/8"

Per cassette alte e basse, in ceramica o plastica, con cappuccio, diaframma di strozzamento e compensatore di spostamento.



codice	UM	min. ord. conf.	cat.	prezzo (€)
● 37092000	NR	1	10	

VALVOLA DI CARICO



codice	UM	min. ord. conf.	cat.	prezzo (€)
● 43991000	NR	1	10	

VALVOLA DI SCARICO PER CASSETTE 37594



codice	UM	min. ord. conf.	cat.	prezzo (€)
● 42253000	NR	1	10	

VALVOLA SCARICO COMPLETA



codice	UM	min. ord. conf.	cat.	prezzo (€)
● 42961000	NR	1	10	

VALVOLA DI SCARICO CON INTERRUZIONE



codice	UM	min. ord. conf.	cat.	prezzo (€)
● 43992000	NR	1	10	

VALVOLA SCARICO PER CASSETTA ESTERNA



codice	UM	min. ord. conf.	cat.	prezzo (€)
● 43486000	NR	1	10	

PISTONE VALVOLA SCARICO PER CASSETTA ESTERNA



codice	UM	min. ord. conf.	cat.	prezzo (€)
● 43544000	NR	1	10	

SFERA VALVOLA SCARICO PER CASSETTA 37051



codice	UM	min. ord. conf.	cat.	prezzo (€)
● 43917000	NR	1	10	

MEMBRANA CARICO



codice	UM	min. ord. conf.	cat.	prezzo (€)
● 43733000	NR	1	10	

TRAVERSA



codice	UM	min. ord. conf.	cat.	prezzo (€)
● 42962000	NR	1	10	

SCALETTA AZIONAMENTO



codice	UM	min. ord. conf.	cat.	prezzo (€)
● 43546000	NR	1	10	

LEVA COMPLETA PER CASSETTA 37643



codice	UM	min. ord. conf.	cat.	prezzo (€)
● 43985000	NR	1	10	

PIASTRA DI PROTEZIONE PER CASSETTA 37643



codice	UM	min. ord. conf.	cat.	prezzo (€)
● 43966000	NR	1	10	

GUARNIZIONE















codice	UM	min. ord. conf.	cat.	prezzo (€)
● 42310000	NR	1	10	

LAVATOI

LAVATOI CON MOBILE

TIPI DI VASCHE

Tipo 1	Tipo 2	Tipo 3	Tipo 4	Tipo 5	Tipo 6	Tipo 7
						
Prof. 23,5	Prof. 22,5	Prof. 23,5	Prof. 21,5	Prof. 23,5	Prof. 23,5	Prof. 28,5
Tipo 8 / BI-VASCA	Tipo 9	Tipo 10	Tipo 11	Tipo 12	Tipo 13	
						
Prof. 19,5 - 22,5	Prof. 26	VASCA A DESTRA Prof. 22,5	VASCA A SINISTRA Prof. 22,5	VASCA A DESTRA Prof. 22,5	VASCA A SINISTRA Prof. 22,5	

Prof.: profondità della vasca in corrispondenza della piletta.

FUTURA



Caratteristiche:

- mobile in bilaminato idrofugo, sportelli lucidi con angoli arrotondati, maniglie nichel spazzolato lucido
- vasca in resina, forabile per installazione del rubinetto
- cerniere ante chiusura rallentata e vassoio salvafondo in alluminio
- asse in pino verniciato e sifone autopulente con attacco lavatrice, particolari inox
- zoccolo in PVC ricoperto con lamina in alluminio estraibile per una facile pulizia sotto il mobile (escluso i coprilavatrice)
- piedini regolabili in altezza fino a 15 mm.

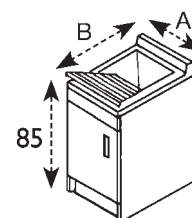

codice	sigla	AxB (cm)	tipo vasca	N° ante	UM	min. ord. conf.	cat.	prezzo (€)
3402001	2006FB	45x50	1	1	NR	1	03	
3402005	2005FB	45x60	2	1	NR	1	03	
3402002	2003FB	50x50	3	1	NR	1	03	
3402006	2009FB	60x45	4	2	NR	1	03	
3402003	2002FB	60x50	5	2	NR	1	03	
3402004	2007FB	60x60	6	2	NR	1	03	
3402008	2013FB	75x60	7	2	NR	1	03	
3402007	2012FB	75x60	8	2	NR	1	03	
3402009	2010FB	80x50	9	2	NR	1	03	

FUTURA COPRILAVATRICE



Caratteristiche:

- mobile in bilaminato idrofugo, sportelli lucidi con angoli arrotondati, maniglie nichel spazzolato lucido
- vasca in resina, forabile per installazione del rubinetto
- cerniere ante chiusura rallentata e vassoio salvafondo in alluminio
- asse in pino verniciato e sifone autopulente con attacco lavatrice, particolari inox
- zoccolo in PVC ricoperto con lamina in alluminio estraibile per una facile pulizia sotto il mobile (escluso i coprilavatrice)
- piedini regolabili in altezza fino a 15 mm.

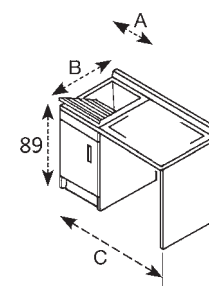

Versione SX

codice	sigla	AxBxC (cm)	tipo vasca	N° ante	UM	min. ord. conf.	cat.	prezzo (€)
3402010	2008FBDX	45x60x109	10	1	NR	1	03	
3402012	2008FBSX	45x60x109	11	1	NR	1	03	
3402011	2800FBDX	60x60x124	12	2	NR	1	03	
3402013	2800FBSX	60x60x124	13	2	NR	1	03	

PRATIKA

**Caratteristiche:**

- mobile in bilaminato idrofugo, sportelli con angoli squadrati, maniglie e piedini satinati
- vasca in resina, forabile per l'installazione del rubinetto
- asse in resina plastica, su richiesta asse in legno verniciato
- sifone autopulente con attacco lavatrice e troppo pieno

codice	sigla	AxB (cm)	tipo vasca	N° ante	UM	min. ord. conf.	cat.	prezzo (€)
3403001	3006SB	45x50	1	1	NR	1	03	
3403005	3005SB	45x60	2	1	NR	1	03	
3403002	3003SB	50x50	3	1	NR	1	03	
3403006	3009SB	60x45	4	2	NR	1	03	
3403003	3002SB	60x50	5	2	NR	1	03	
3403004	3007SB	60x60	6	2	NR	1	03	
3403007	3013SB	75x60	7	2	NR	1	03	
3403009	3012SB	75x60	8	2	NR	1	03	
3403008	3010SB	80x50	9	2	NR	1	03	

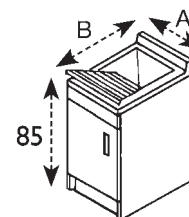

ROCKY

**Caratteristiche:**

- mobile in bilaminato idrofugo, sportelli con angoli squadrati, maniglie e piedini satinati
- vasca in resina, forabile per l'installazione del rubinetto
- asse in resina plastica, su richiesta asse in legno verniciato
- sifone autopulente con attacco lavatrice e troppo pieno

codice	sigla	AxBxC (cm)	tipo vasca	N° ante	UM	min. ord. conf.	cat.	prezzo (€)
3407061	6006SK	45x50	1	1	NR	1	03	
3407062	6003SK	50x50	3	1	NR	1	03	
3407063	6002SK	60x50	5	2	NR	1	03	
3407064	6007SK	60x60	6	2	NR	1	03	

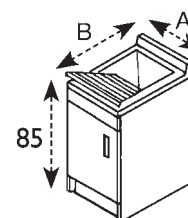

QUEEN VASCA IN CERAMICA

**Caratteristiche:**

- mobile in bilaminato idrofugo, sportelli con angoli squadrati, maniglie satiniate
- cerniere ante a chiusura rallentata e vassoio salva-fondo in alluminio
- vasca in ceramica, con foro per l'installazione del rubinetto
- senza asse, su richiesta asse in legno verniciato
- sifone autopulente con pilettoni 3"1/2 con accessori inox
- piedini regolabili in altezza fino a 15 mm.



codice	sigla	AxB (cm)	N° ante	UM	min. ord. conf.	cat.	prezzo (€)
3405030	2002BCER	60x50	2	NR	1	03	

LAVATOI

LAVATOI CON MOBILE

JUNIOR PER ESTERNO (IN KIT, SMONTATO)



Caratteristiche:

- mobile interamente in PVC resistente all'umidità, adatto per esterni o luoghi umidi (garage, cantine, giardini, terrazzi)
- kit automontante, montaggio senza l'ausilio di attrezzi, in quanto senza viti
- maniglie cromate
- vasca in resina, forabile per installazione del rubinetto
- asse in resina
- sifone autopulente con attacco lavatrice
- piedini regolabili in altezza fino a 15 mm.

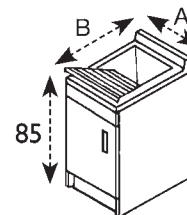

codice	sigla	finitura	AxB (cm)	tipo vasca	N° ante	UM	min. ord. conf.	cat.	prezzo (€)
3407005	9006K	BIANCO	45x50	1	1	NR	1	03	
3407006	9003K	BIANCO	50x50	3	1	NR	1	03	
3407007	9002K	BIANCO	60x50	5	2	NR	1	03	
3407008	9007K	BIANCO	60x60	6	2	NR	1	03	

SANITARI

JUNIOR LAVATOIO PER ESTERNO



Caratteristiche:

- mobile interamente in PVC con trattamento anti-invecchiamento resistente all'umidità, adatto per esterni o luoghi umidi (garage, cantine, giardini, terrazzi)
- sportelli con chiusura a battente calamitata
- maniglie cromate
- vasca in resina, forabile per installazione del rubinetto
- asse in resina, su richiesta asse in legno verniciato
- sifone autopulente con troppo pieno
- piedini regolabili in altezza fino a 15 mm.

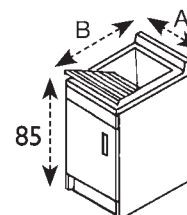

codice	sigla	AxB (cm)	tipo vasca	N° ante	UM	min. ord. conf.	cat.	prezzo (€)
3405001	9006	45x50	1	1	NR	1	03	
3405002	9003	50x50	3	1	NR	1	03	
3405003	9002	60x50	5	2	NR	1	03	
3405004	9007	60x60	6	2	NR	1	03	

MOBILETTO SOTTOCERAMICA

Per lavatoi di ceramica in appoggio, compatibile con modello Messico (Dolomite) e Iseo (Pozzi Ginori).

Caratteristiche:

- mobile in bilaminato
- sportelli con angoli squadrati
- due ante con maniglie cromate
- piedini cromati regolabili in altezza 15mm

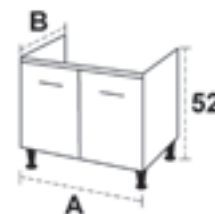

codice	sigla	AxB (cm)	compatibilità	UM	min. ord. conf.	cat.	prezzo (€)
3405021	2016	47x32	Messico 60	NR	1	03	
3405022	2017	60x42	Messico 75 - Iseo 75	NR	1	03	

PILOZZI



GRIGIO

Caratteristiche:

- in polipropilene lucido sia internamente che esternamente
- ideale per esterni
- resistente agli acidi, ai prodotti chimici e agli agenti atmosferici
- completo di sifone e piletta con troppopieno
- fissaggi a corredo

codice	sigla	AxBxC (cm)	colore	UM	min. ord. conf.	cat.	prezzo (€)
3408001	2051	50x34x21	bianco	NR	1	03	
3408003	2051B	59x34x21	bianco	NR	1	03	
3408011	2051G	50x34x21	grigio	NR	1	03	
3408013	2051BG	59x34x21	grigio	NR	1	03	

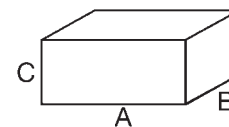

Con portasapone e predisposizione per rubinetto e dosatore



GRIGIO

codice	sigla	AxBxC (cm)	colore	UM	min. ord. conf.	cat.	prezzo (€)
3408002	2051A	55x34x21	bianco	NR	1	03	
3408012	2051AG	55x34x21	grigio	NR	1	03	

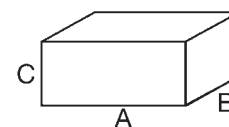

CATALOGO
LISTINO N° 6

COMPLEMENTI SANITARI

COMPLEMENTI
SANITARI

SIFONAME	154
RUBINETTERIA SOTTOLAVABO, LAVATRICE E VARIA	174
FLESSIBILI ACQUA E ANTIVIBRANTI	181
SISTEMI DI FISSAGGIO	184
TRITURATORI E POMPE SOLLEVAMENTO	185

SIFONAME

SIFONI A VISTA IN OTTONE

Sifoni per lavabi a vista in ottone cromato, design minimale e finiture accurate. Speciali raccordi filettati (anelli cilindrici) che sostituiscono i dadi tradizionali. Rosone piatto. Completamente ispezionabili per la pulizia periodica.

SIFONE A VISTA TAPPO A VISTA



codice	∅	tubo uscita (lungh. mm)	UM	min. ord.	conf.	cat.	prezzo (€)
● 2601017	1"1/4x32	300	NR	1	10	05	



SIFONE A VISTA MINIMAL



codice	finitura	∅	tubo uscita (lungh. mm)	UM	min. ord.	conf.	cat.	prezzo (€)
● 2601018	cromo	1"1/4x32	250	NR	1	10	05	
● 2601918	nero opaco	1"1/4x32	250	NR	1	10	05	
● 2601718	bianco opaco	1"1/4x32	250	NR	1	1	05	
● 2601818	simil acciaio	1"1/4x32	250	NR	1	1	05	



SIFONE A VISTA INGOMBRO RIDOTTO



codice	∅	tubo uscita (lungh. mm)	UM	min. ord.	conf.	cat.	prezzo (€)
● 2601016	1"1/4x32	300	NR	1	10	05	



SIFONE A VISTA SALVASPAZIO



codice	∅	tubo uscita (lungh. mm)	UM	min. ord.	conf.	cat.	prezzo (€)
● 2601013	1"1/4x32	100	NR	1	8	05	



SIFONE A "S"

Da pressofusione. Rosone inox.



	codice	∅	tubo uscita (lungh. mm)	UM	min. ord.	conf.	cat.	prezzo (€)
●	2101001	1"1/4x32	250	NR	30	30	05	
●	2101002	1"x26	250	NR	1	30	05	

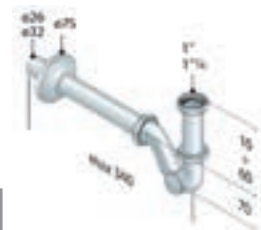

SIFONE A "S" PESANTE

Da fusione in conchiglia. Rosone in ottone.



	codice	∅	tubo uscita (lungh. mm)	UM	min. ord.	conf.	cat.	prezzo (€)
●	2101011	1"1/4x32	250	NR	10	10	05	
●	2101012	1"x26	250	NR	1	10	05	

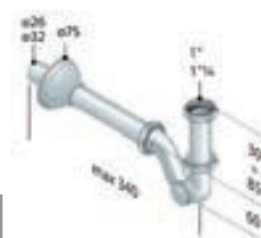

SIFONE A "U"

Da pressofusione. Rosone inox.



	codice	∅	tubo uscita (lungh. mm)	UM	min. ord.	conf.	cat.	prezzo (€)
●	2102001	1"1/4x32	250	NR	30	30	05	
●	2102002	1"x26	250	NR	1	30	05	

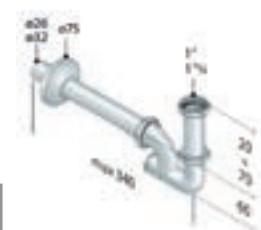

SIFONE A "U" PESANTE

Da fusione in conchiglia. Rosone in ottone.



	codice	∅	tubo uscita (lungh. mm)	UM	min. ord.	conf.	cat.	prezzo (€)
●	2102101	1"1/4x32	250	NR	10	10	05	
●	2102102	1"x26	250	NR	1	10	05	

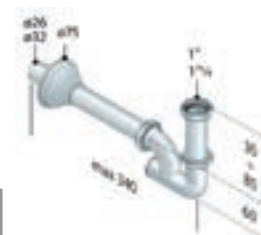

SIFONE BOTTIGLIA

Da pressofusione. Rosone inox.



	codice	∅	tubo uscita (lungh. mm)	UM	min. ord.	conf.	cat.	prezzo (€)
●	2103001	1"1/4x32	250	NR	1	30	05	
●	2103002	1"x26	250	NR	1	30	05	

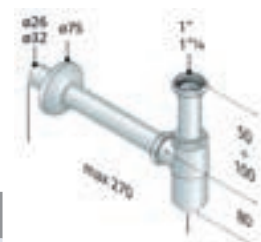

SIFONAME

SIFONI OTTONE LAVABO BIDET

SIFONE BOTTIGLIA PESANTE

Da fusione in conchiglia. Rosone in ottone.



codice	∅	tubo uscita (lung. mm)	UM	min. ord.	conf.	cat.	prezzo (€)
● 2103003	1"1/4x32	250	NR	1	10	05	

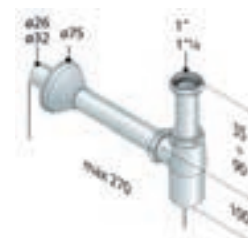

SIFONE LAVABO/BIDET INGOMBRO RIDOTTO



codice	sigla	∅	tubo uscita (lung. mm)	UM	min. ord.	conf.	cat.	prezzo (€)
● 2601006	-522.423.5.	1"1/4x32	250	NR	1	10	05	

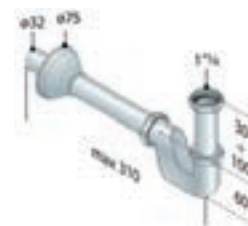

SIFONE TUBOLARE LAVABO/BIDET



codice	∅	tubo uscita (lung. mm)	UM	min. ord.	conf.	cat.	prezzo (€)
● 2601009	1"1/4x32	220	NR	1	15	05	



Sifoni in ABS cromato alla vista del tutto simili a quelli in ottone.
 Nel tubo di entrata, il filetto di collegamento alla piletta è integrato con il resto del tubo, per una installazione più facile e veloce. Completamente ispezionabili per la pulizia periodica.
 Tutti i sifoni di questa sezione (ad esclusione dei sifoni 2601020-2601027), vengono forniti con una riduzione 1" - 1"1/4 così da collegare lo stesso sifone a qualsiasi piletta.

SIFONE ABS A VISTA



codice	∅	tubo uscita (lungh. mm)	UM	min. ord.	conf.	cat.	prezzo (€)
● 2601020	1"1/4x32	300	NR	1	10	05	



SIFONE ABS A "S"



codice	∅	tubo uscita (lungh. mm)	UM	min. ord.	conf.	cat.	prezzo (€)
● 2601024	1"-1"1/4x32	250	NR	1	30	05	



SIFONE ABS A "U"



codice	∅	tubo uscita (lungh. mm)	UM	min. ord.	conf.	cat.	prezzo (€)
● 2601025	1"-1"1/4x32	250	NR	1	30	05	



SIFONE ABS BOTTIGLIA

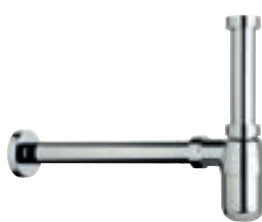

codice	∅	tubo uscita (lungh. mm)	UM	min. ord.	conf.	cat.	prezzo (€)
● 2601021	1"-1"1/4x32	250	NR	1	30	05	



SIFONE ABS A "P"



codice	∅	tubo uscita (lungh. mm)	UM	min. ord.	conf.	cat.	prezzo (€)
● 2601028	1"-1"1/4x32	220	NR	1	15	05	

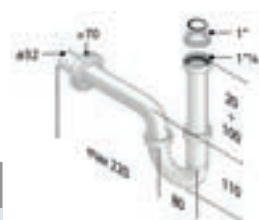

SIFONE ABS, SALVASPAZIO



codice	sigla	∅	tubo uscita (lungh. mm)	UM	min. ord.	conf.	cat.	prezzo (€)
● 2601027	-126.013.5.H	1"1/4x32	220	NR	1	15	05	



**COMPLEMENTI
 SANITARI**

SIFONAME

SIFONI PP LAVABO BIDET

SIFONE IN PP RIDOTTO

Filetto integrato nel tubo di entrata.

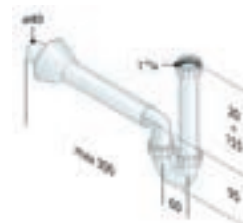

codice	∅	tubo uscita (lungh. mm)	UM	min. ord.	conf.	cat.	prezzo (€)
● 2105101	1"1/4x40	300	NR	1	30	01	

SIFONE IN PP RIBASSATO

Filetto integrato nel tubo di entrata.

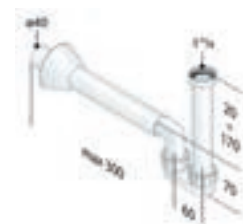

codice	∅	tubo uscita (lungh. mm)	UM	min. ord.	conf.	cat.	prezzo (€)
● 2105001	1"1/4x40	300	NR	1	30	01	

SIFONE IN PP PASSAGGIO ACQUA MAGGIORATO

Filetto integrato nel tubo di entrata.

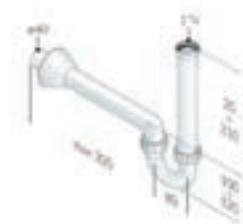

codice	∅	tubo uscita (lungh. mm)	UM	min. ord.	conf.	cat.	prezzo (€)
● 2602007	1"1/4x40	300	NR	1	30	01	

SIFONE IN PP SALVASPAZIO



codice	∅	tubo uscita (lungh. mm)	UM	min. ord.	conf.	cat.	prezzo (€)
● 2204104	1"1/4x40	300	NR	1	15	01	

SIFONE IN PP MINIMO INGOMBRO

Ingombro minimo a parete (43 mm) e sotto-piletta (32 mm).
Senza tubo di uscita e senza collegamento al troppo pieno.



codice	sigla	∅	UM	min. ord.	conf.	cat.	prezzo (€)
● 2204106	1650.500.5	1"1/4x32	NR	1	16	01	

SIFONE IN PP, LAVELLO 1 BACINO, 2 ATTACCHI LAVATRICE

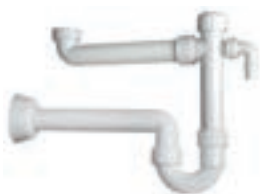

codice	∅	tubo uscita (lungh. mm)	UM	min. ord.	conf.	cat.	prezzo (€)
● 2203001	1"1/2X40	250	NR	1	10	01	

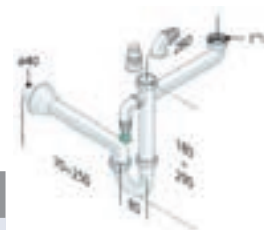

SIFONE IN PP, LAVELLO 2 BACINI, 2 ATTACCHI LAVATRICE



codice	∅	tubo uscita (lungh. mm)	UM	min. ord.	conf.	cat.	prezzo (€)
● 2203101	1"1/2X40	250	NR	1	10	01	

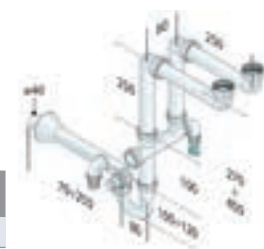

SIFONE IN PP, LAVELLO 1 BACINO, 2 ATTACCHI LAVATRICE



codice	∅	tubo uscita (lungh. mm)	UM	min. ord.	conf.	cat.	prezzo (€)
● 2204102	1"1/2X40	300	NR	1	30	01	

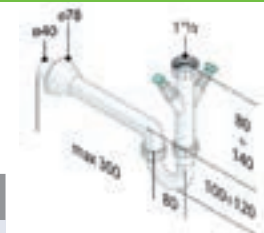

SIFONE IN PP, LAVELLO 2 BACINI, 2 ATTACCHI LAVATRICE



codice	∅	tubo uscita (lungh. mm)	UM	min. ord.	conf.	cat.	prezzo (€)
● 2204103	1"1/2X40	300	NR	1	15	01	

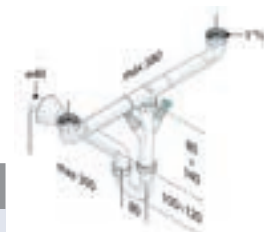

SIFONE IN PP A FIASCO, LAVELLO 1 BACINO, 2 ATTACCHI LAVATRICE



codice	∅	tubo uscita (lungh. mm)	UM	min. ord.	conf.	cat.	prezzo (€)
● 2205102	1"1/2X40	300	NR	1	15	01	



SIFONE IN PP A FIASCO, LAVELLO 2 BACINI, 2 ATTACCHI LAVATRICE



codice	∅	tubo uscita (lungh. mm)	UM	min. ord.	conf.	cat.	prezzo (€)
● 2205104	1"1/2X40	300	NR	1	15	01	

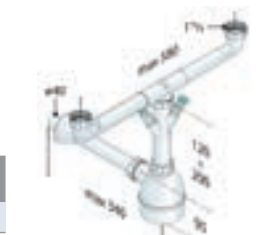

COMPLEMENTI
SANITARI

SIFONAME

SIFONI PAVIMENTO

LE CARATTERISTICHE CHE ACCOMUNANO TUTTI I DIVERSI TIPI DI SCARICO SONO:

- 1) sifone estraibile per pulizie periodiche e per ispezionare o disotturare le tubazioni poste a valle
- 2) griglie regolabili in altezza (escluso Basicflow)
- 3) piedini di regolazione per facilitare la posa
- 4) telo perimetrale per impermeabilizzazione, fissabile direttamente con la colla per piastrelle

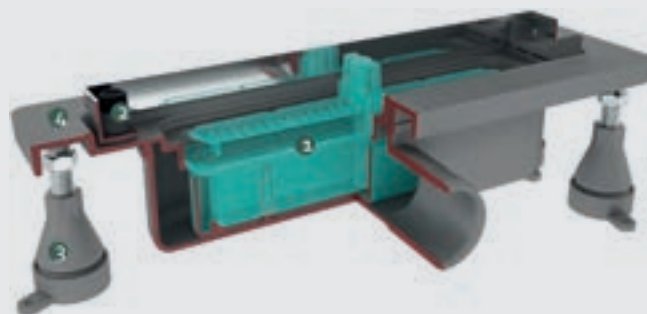

NANOFLOW PIASTRELLABILE



Caratteristiche:

- canalina in ABS
- griglia acciaio inox regolabile in altezza per pavimenti di spessore 15-25 mm
- griglia piastrellabile o in acciaio inox AISI 316 satinato
- ingombro sotto il pavimento di 75 mm
- chiusura idraulica 35 mm
- portata d'acqua 40 lt/min

codice	sigla	griglia (mm)	UM	min. ord. conf.	cat.	prezzo (€)
● 2304950	-953.101.8.	300X50	NR	1	04	
● 2304954	-953.701.8.	500X50	NR	1	04	
● 2304955	-953.801.8.	600X50	NR	1	04	
● 2304951	-953.901.8.	700X50	NR	1	04	
● 2304952	-953.201.8.	800X50	NR	1	04	
● 2304953	-953.301.8.	900X50	NR	1	04	

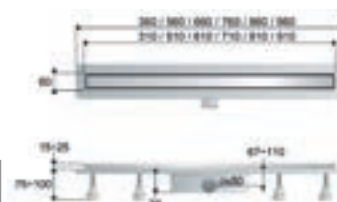

BASICFLOW



Caratteristiche:

- canalina in ABS
- realizzato in unico pezzo
- ottimo rapporto qualità/prezzo
- griglia in acciaio inox AISI 316 non regolabile in altezza, con possibilità di foggia diversa
- ingombro sotto il pavimento di 70 mm
- chiusura idraulica 35 mm
- portata d'acqua 39 lt/min

codice	sigla	griglia (mm)	UM	min. ord. conf.	cat.	prezzo (€)
● 2304960	-943.506.8.	400x43	NR	1	04	
● 2304963	-943.906.8.	700x43	NR	1	04	
● 2304964	-943.206.8.	800x43	NR	1	04	
● 2304965	-943.306.8.	900x43	NR	1	04	

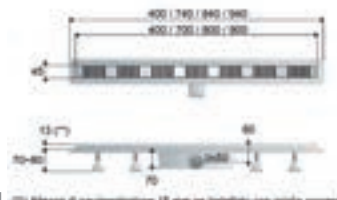

(*) Altezze di pavimentazione 15 mm se installato con griglia coprente

SUMISURA



Caratteristiche:

- canalina in ABS
- regolabile in lunghezza da max 1.200 mm a min. 430 mm
- griglia acciaio inox AISI 316 regolabile in altezza da 7 a 22 mm
- supporti scorrevoli adatti a ogni lunghezza e regolabili in altezza
- chiusura idraulica 35 mm
- portata d'acqua 36 lt/min
- ingombro sotto il pavimento di 75mm
- compreso DIMA per il corretto taglio della canalina e della griglia

Con i raccordi speciali (2304972 e 2304974) è possibile assemblare più canaline

codice	sigla	misura (mm)	UM	min. ord. conf.	cat.	prezzo (€)
● 2304970	-983.201.8	430÷800	NR	1	04	
● 2304971	-983.401.8	430÷1200	NR	1	04	

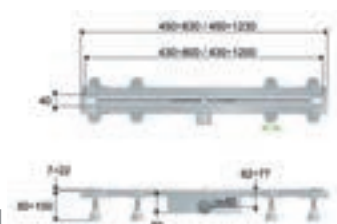

RACCORDO LINEARE PER GIUNZIONE SET SUMISURA



	codice	sigla	UM	min. ord. conf.	cat.	prezzo (€)
●	2304972	-987.000.0	NR	1	04	

RACCORDO ANGOLARE PER GIUNZIONE SET SUMISURA



	codice	sigla	UM	min. ord. conf.	cat.	prezzo (€)
●	2304974	-987.004.0.	NR	1	04	

MINIFLOW LINEARE

Caratteristiche:

- griglia in acciaio inox con possibilità di fogge diverse
- porta-griglia regolabile in altezza
- ingombro sotto il pavimento di 85 mm
- chiusura idraulica 35 mm
- portata d'acqua 39 lt/min

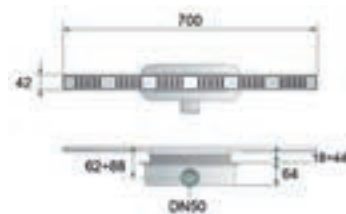

	codice	sigla	griglia (mm)	telo (mm)	UM	min. ord. conf.	cat.	prezzo (€)
●	2304802	-963.106.8.	700x42	1000x500	NR	1	04	

MINIFLOW QUADRATO

Caratteristiche:

- griglia in acciaio inox con possibilità di fogge diverse
- porta-griglia regolabile in altezza
- ingombro sotto il pavimento di 85 mm
- chiusura idraulica 35 mm
- portata d'acqua 36 lt/min

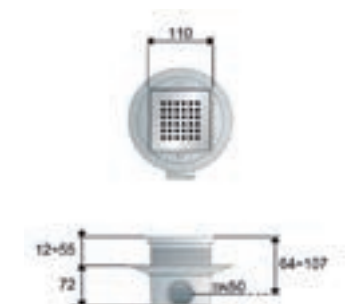

	codice	sigla	griglia (mm)	telo (mm)	UM	min. ord. conf.	cat.	prezzo (€)
●	2304801	-971.101.8.	110x110	500x500	NR	1	04	

SIFONE PAVIMENTO IN OTTONE GRIGLIA OTTONE mm. 120

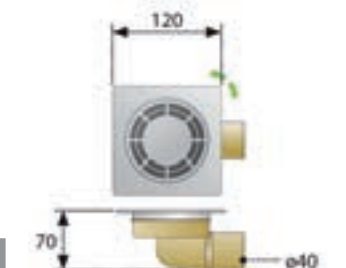

	codice	sigla	Ø	UM	min. ord. conf.	cat.	prezzo (€)
●	2403001	--65.400.6.	120x40	NR	1	15	01

SIFONAME

SIFONI PAVIMENTO

SIFONE PAVIMENTO IN OTTONE GRIGLIA OTTONE CROMATO mm.100



codice	sigla	Ø	UM	min. ord.	conf.	cat.	prezzo (€)
● 2403101	--62.405.5.	100x1"1/4	NR	2	30	01	

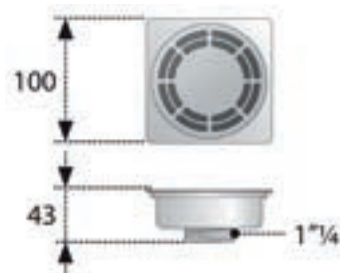

SIFONE PAVIMENTO ABS GRIGLIA INOX mm.105



codice	sigla	Ø	UM	min. ord.	conf.	cat.	prezzo (€)
● 2402401	-265.201.8.	105x50	NR	1	10	01	

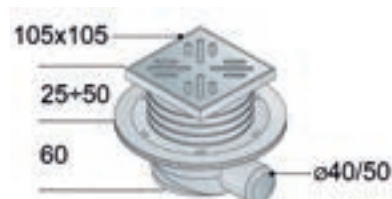

SIFONE PAVIMENTO ABS GRIGLIA OTTONE CROMATO mm.120

Griglia regolabile in altezza. Cornice quadra orientabile. Flangia per predisposizione all'impermeabilizzazione a letto sottile. Ridotto ingombro sotto traccia (6 cm). Adatto per esterno. Ispezionabile. Per evitare allagamenti, reflussi, cattivi odori a causa dello svuotamento del sifone, è possibile inserire il sifone a secco con sistema a clapet (2661099).



codice	sigla	Ø	UM	min. ord.	conf.	cat.	prezzo (€)
● 2403401	2665.491.8.	120x50	NR	1	10	01	

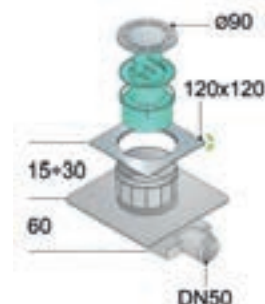

SIFOIDE PAVIMENTO ABS GRIGLIA ACCIAIO INOX AISI 316 mm.115

Griglia PIASTRELLABILE regolabile in altezza. Cornice quadra orientabile. Flangia per predisposizione all'impermeabilizzazione a letto sottile. Ridotto ingombro sotto traccia (6 cm). Adatto per esterno. Ispezionabile. Per evitare allagamenti, reflussi, cattivi odori a causa dello svuotamento del sifone, è possibile inserire il sifone a secco con sistema a clapet (2661099).



codice	sigla	Ø	UM	min. ord.	conf.	cat.	prezzo (€)
● 2403402	-2665.492.8	115x50	NR	1	10	01	

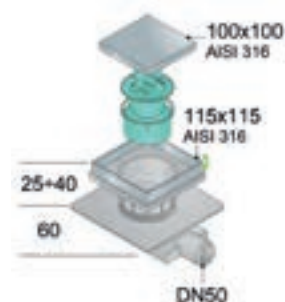

SIFONE A SECCO PER SIFOIDE

Con sistema clapet per sifoide a pavimento 2403401, 2403402.



codice	sigla	UM	min. ord.	conf.	cat.	prezzo (€)
● 2661099	-137.013.0.	NR	1	20		

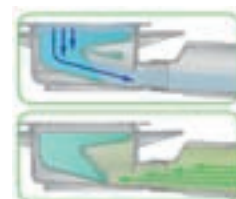

SIFONI E PILETTE PIATTI DOCCIA

SIFONE PIATTO DOCCIA CON FORO D.90, GRIGLIA IN ABS CROMO, RIBASSATO

Griglia coprente D.118 in ABS, sifone e cestello ferma-capelli amovibili, guarnizione tre lamelle adatta ai piatti doccia in acrilico che quelli in ceramica, uscita con ghiera. Basso ingombro, portata d'acqua maggiorata. Fissaggio con viti.



RICAMBI (PAG. 173)
2661106 - Griglia



codice	piletta Ø	uscita Ø	UM	min. ord. conf.	cat.	prezzo (€)
● 2303007	110	1"1/2	NR	16	01	

SIFONE PIATTO DOCCIA CON FORO D.90, GRIGLIA IN ABS CROMO, RIBASSATO

Griglia coprente D.118 in ABS, sifone e cestello ferma-capelli amovibili, guarnizione tre lamelle adatta ai piatti doccia in acrilico che quelli in ceramica, uscita con codolo 45° in PP. Basso ingombro, portata d'acqua maggiorata. Fissaggio con viti.



RICAMBI (PAG. 173)
2661106 - Griglia



codice	sigla	piletta Ø	uscita Ø	UM	min. ord. conf.	cat.	prezzo (€)
● 2303008	6261.078.8.	110	40-50	NR	12	01	

SIFONE PIATTO DOCCIA CON FORO D.90, GRIGLIA METALLICA, RIBASSATO

Griglia coprente D.118 metallica colorata, sifone e cestello ferma-capelli amovibili, uscita con ghiera. Basso ingombro. Fissaggio con viti.

NOVITÀ!

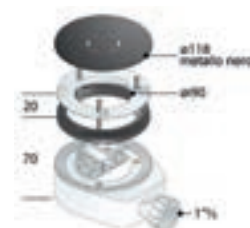

codice	sigla	finitura	piletta Ø	uscita Ø	UM	min. ord. conf.	cat.	prezzo (€)
2303911	6261.086.6.X	nero opaco	110	1"1/2	NR	1	16	01
2303711	6261.086.6.XD	bianco opaco	110	1"1/2	NR	1	16	01

SIFONE PIATTO DOCCIA CON FORO D.50 E D.60, GRIGLIA OTTONE, RIBASSATO

Griglia D.45 in ottone cromo, sifone e cestello ferma-capelli amovibili, uscita con ghiera. Basso ingombro. Fissaggio con viti.



codice	sigla	piletta Ø	uscita Ø	UM	min. ord. conf.	cat.	prezzo (€)
● 2303009	6461.066.6.	80	1"1/2	NR	1	16	01

SIFONE PIATTO DOCCIA CON FORO D.50 E D.60, GRIGLIA IN ABS CROMO, RIBASSATO

Griglia coprente D.85 in ABS, sifone e cestello ferma-capelli amovibili, uscita con ghiera. Basso ingombro. Fissaggio con viti.



codice	sigla	piletta Ø	uscita Ø	UM	min. ord. conf.	cat.	prezzo (€)
● 2303010	6461.096.6.	80	1"1/2	NR	1	16	01

SIFONAME

SIFONI E PILETTE PIATTI DOCCIA

SIFONE PIATTO DOCCIA CON FORO D.60 , GRIGLIA OTTONE CROMO, ORIENTABILE

Griglia D.45 ottone cromo, cestello ferma-capelli amovibile, uscita orientabile liscia in PEHD saldabile con tubi in PE.



codice	entrata Ø	uscita Ø	UM	min. ord.	conf.	cat.	prezzo (€)
● 2302101	80	40-50	NR	1	30	01	

SIFONI E COLONNE SCARICO VASCA

SIFONE VASCA IN PP, USCITA ORIENTABILE A SALDARE

Sifone ribassato, entrata con dado in ottone, uscita orientabile liscia in PEHD saldabile con tubi in PE.

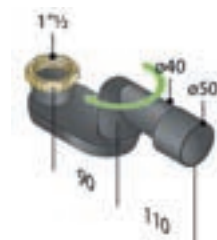

codice	sigla	entrata Ø	uscita Ø	UM	min. ord.	conf.	cat.	prezzo (€)
● 2302102	-290.400.8.	1"1/2	40-50	NR	1	30	01	

SIFONE VASCA IN PP, USCITA ORIENTABILE CON GHIERA

Sifone ribassato, entrata con dado in ottone, uscita orientabile con ghiera in PP.

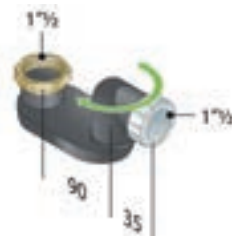

codice	sigla	entrata Ø	uscita Ø	UM	min. ord.	conf.	cat.	prezzo (€)
● 2302104	-290.407.6.	1"1/2	1"1/2	NR	1	30	01	

COLONNA VASCA IN PP TUBO RIGIDO, CON SIFONE ORIENTABILE

Comando a cavo inox, sifone pre-assemblato con codolo 45°, tappo D.45 in ottone, griglia tappo troppo pieno in metallo cromato.



codice	uscita Ø	UM	min. ord.	conf.	cat.	prezzo (€)
● 2304309	40-50	NR	1	10	01	

PILETTE OTTONE LAVABO BIDET

PILETTA AUTOMATICA UNIVERSALE



Ideale per lavabi di diversi spessori, tappo coprente in ottone cromato, meccanismo clicker, vite centrale passante da 75 mm.

codice	sigla	Ø	tappo (mm)	UM	min. ord. conf.	cat.	prezzo (€)
● 2106020	8532.310.5.	1"1/4	63	NR	15	01	



PILETTA UNIVERSALE MINIMO INGOMBRO



Meccanismo clicker, tappo coprente, vite passante per lavabi di spessore fino a 60 mm. Tappo metallico D.63



codice	sigla	finitura	Ø	UM	min. ord.	conf.	cat.	prezzo (€)
● 2106037	7532.310.5	cromo	1"1/4	NR	1	15	01	
● 2106937	7532.310.5.X	nero opaco	1"1/4	NR	1	15	01	
● 2106737	7532.310.5.XD	bianco opaco	1"1/4	NR	1	15	01	
● 2106837	7532.310.5.Y2	simil acciaio	1"1/4	NR	1	15	01	



PILETTA UNIVERSALE MINIMO INGOMBRO, TAPPO CERAMICO



Meccanismo clicker, tappo coprente, vite passante per lavabi di spessore fino a 60 mm. Tappo ceramico D.70.



codice	sigla	finitura	Ø	UM	min. ord.	conf.	cat.	prezzo (€)
● 2106537	7532.310.5.T2	nera opaca	1"1/4	NR	1	15	01	
● 2106637	7532.310.5.T1	bianca opaca	1"1/4	NR	1	15	01	



PILETTA AUTOMATICA UNIVERSALE



Per qualsiasi spessore, con scanalatura per facilitare il taglio e dotata di dispositivo di chiusura del troppo pieno, tappo coprente in ottone cromato, meccanismo clicker.

RICAMBI (PAG. 172)
2661076 - Tappo



codice	finitura	Ø	controdado H (mm)	tappo (mm)	UM	min. ord.	conf.	cat.	prezzo (€)
● 2106029	cromo	1"1/4	80	63	NR	1	15	01	
● 2106929	nero opaco	1"1/4	80	63	MR	1	15	01	

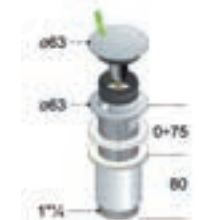

PILETTA AUTOMATICA UNIVERSALE



Per qualsiasi spessore, con scanalatura per facilitare il taglio e dotata di dispositivo di chiusura del troppo pieno, tappo coprente in ottone cromato, meccanismo clicker.

RICAMBI (PAG. 172)
2661076 - Tappo

codice	Ø	controdado H (mm)	tappo (mm)	UM	min. ord.	conf.	cat.	prezzo (€)
● 2106035	1"1/4	40	63	NR	1	15	01	



PILETTA AUTOMATICA LAVABO/BIDET TAPPO COPRENTE



Meccanismo clicker.

RICAMBI (PAG. 172)
2661076 - Tappo

codice	Ø	tappo (mm)	descrizione	UM	min. ord. conf.	cat.	prezzo (€)
● 2106012	1"1/4	63	con troppo pieno	NR	15	01	
● 2106013	1"1/4	63	senza troppo pieno	NR	15	01	



SIFONAME

PILETTE OTTONE LAVABO BIDET

PILETTA A SCARICO LIBERO



Con griglia ferma capelli estraibile, vite centrale passante da 75 mm.



codice	sigla	Ø	griglia (mm)	UM	min. ord.	conf.	cat.	prezzo (€)
● 2106015	-542.710.5.	1"1/4	65	NR	1	15	01	

PILETTA TAPPO SALTERELLO, SENZA COMANDO

Piletta in ottone, tappo in ottone.



RICAMBI (PAG. 173)
2661095 - Tappo

codice	Ø	tappo (mm)	UM	min. ord.	conf.	cat.	prezzo (€)
● 2106003	1"1/4x63	40	NR	1	30	01	
● 2106002	1" x63 (fuori norma)	40	NR	1	30	01	

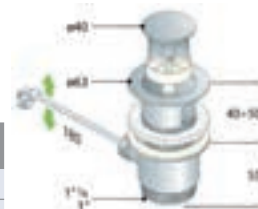

TAPPO COPRENTE CLICKER

Con sistema clicker per sostituzione tappo su vecchie pilette da 1"1/4.



codice	sigla	Ø	UM	min. ord.	conf.	cat.	prezzo (€)
● 2661097	8120.378.5	63	NR	10	20		



PILETTA IN OTTONE TAPPO SALTERELLO IN PVC, SENZA COMANDO

Piletta in ottone, tappo in PVC.



codice	Ø	tappo (mm)	UM	min. ord.	conf.	cat.	prezzo (€)
● 2106034	1"1/4x63	37,9	NR	1	50	01	
● 2106025	1" x63 (fuori norma)	37,9	NR	1	50	01	

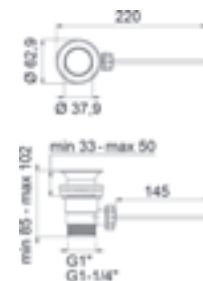

PILETTA CON TAPPO E CATENELLA

Piletta in ottone H.70 mm, sottoparte in resina acetilica (POM).



codice	sigla	Ø	tappo (mm)	descrizione	UM	min. ord.	conf.	cat.	prezzo (€)
● 2106008	-329.120.5.	1"1/4x63	40,5	con troppo pieno	NR	1	30	01	
● 2106007	-329.120.4.	1" x63	40,5	con troppo pieno	NR	1	30	01	
● 2106102	-329.020.5.	1"1/4x63	40,5	senza troppo pieno	NR	1	30	01	
● 2106101	-329.020.4.	1" x63	40,5	senza troppo pieno	NR	1	30	01	



SET COLLEGAMENTO CON TROPPO PIENO PP-GRIGLIA OTTONE PER LAVABO

Per lavabo con spessore 5÷20 mm per fori D. 30 mm.
Tubo flessibile lunghezza max 300 mm.



codice	sigla	UM	min. ord.	conf.	cat.	prezzo (€)
● 2304317	-247.604.0.	NR	1	15	01	



PILETTA IN PP LAVELLI INOX FORO D.90, CON TROPPO PIENO, TAPPO INOX

Tappo cestello inox estraibile, troppo pieno con tubo flessibile



RICAMBI (PAG. 172-173)
2661061 - Vite prolungata 65 mm
2661058 - Tappo

codice	sigla	Ø	tappo (mm)	UM	min. ord.	conf.	cat.	prezzo (€)
● 2201001	-133.605.6.	1"1/2x115	80	NR	1	10	01	

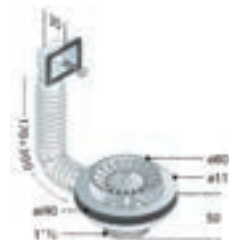

PILETTA IN PP LAVELLI INOX FORO D.90, SENZA TROPPO PIENO, TAPPO INOX

Tappo cestello D.80 inox estraibile.



RICAMBI (PAG. 172-173)
2661061 - Vite prolungata 65 mm
2661058 - Tappo

codice	sigla	Ø	tappo (mm)	UM	min. ord.	conf.	cat.	prezzo (€)
● 2201101	-133.505.6.	1"1/2x115	80	NR	1	15	01	

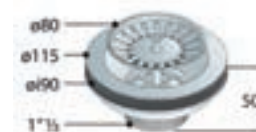

PILETTA IN PP LAVELLI INOX FORO D.60, CON TROPPO PIENO, TAPPO E CATENELLA

Gattinara inox, tappo in gomma catenella e vite.
 Troppo pieno con tubo flessibile.



codice	sigla	Ø	tappo (mm)	UM	min. ord.	conf.	cat.	prezzo (€)
● 2201002	-232.840.6.	1"1/2x70	45	NR	1	30	01	

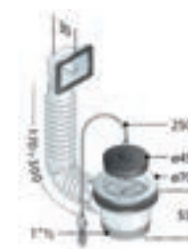

PILETTA IN PP LAVELLI INOX FORO D.60, SENZA TROPPO PIENO

Gattinara inox, tappo in gomma con catenella e vite.



codice	sigla	Ø	tappo (mm)	UM	min. ord.	conf.	cat.	prezzo (€)
● 2201102	-232.540.6.	1"1/2x70	45,5	NR	1	10	01	
● 2201103	-234.540.6.	1"1/2x70	50,0	NR	1	10	01	



PILETTONE SIFOIDE LEVELLO, TAPPO E CATENELLA

Griglia-cestello in ottone, sottoparte in ottone.



codice	sigla	Ø	tappo (mm)	UM	min. ord.	conf.	cat.	prezzo (€)
● 2201202	--37.125.5.	1"1/4x80	50,5	NR	1	15	01	



SIFONAME

PILETTE LAVELLO

PILETTA GATTINARA LAVELLI IN FC

Gattinara inox, sottoparte in PP.



codice	sigla	Ø	descrizione	UM	min. ord.	conf.	cat.	prezzo (€)
● 2202001	-234.625.5.	1"1/4x80	con catenella	NR	1	10	01	
● 2202002	-234.625.6.	1"1/2x80	con catenella	NR	1	10	01	
● 2202003	-234.635.6.	1"1/2x80	con maniglia	NR	1	10	01	

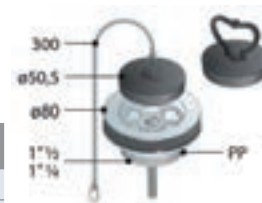

PILETTA GATTINARA

Sottoparte in ottone, tappo con catenella, gattinara inox.



codice	sigla	Ø	tappo (mm)	UM	min. ord.	conf.	cat.	prezzo (€)
● 2201201	--34.625.5.	1"1/4x80	50,5	NR	1	50	01	
● 2602015	--34.625.6.	1"1/2x80	50,5	NR	1	50	01	



TUBI CROMATI IN OTTONE

TUBO ORLATO

Con cartella ribattuta.



codice	sigla	∅	lungh. (cm)	UM	min. ord. conf.	cat.	prezzo (€)
● 2651018	-	26	20	NR	10	09	
● 2651020	-	26	25	NR	10	09	
● 2651022	-	26	30	NR	10	09	
● 2651031	-	30	30	NR	10	09	
● 2651019	-	32	20	NR	10	09	
● 2651021	-	32	25	NR	10	09	
● 2651023	-	32	30	NR	10	09	

TUBO LISCIO



codice	∅	lungh. (cm)	UM	min. ord. conf.	cat.	prezzo (€)
● 2750831	26	25	NR	10	09	
● 2750834	26	30	NR	10	09	
● 2750838	26	100	NR	10	09	
● 2750832	30	25	NR	10	09	
● 2750835	30	30	NR	10	09	
● 2750833	32	25	NR	10	09	
● 2750836	32	30	NR	10	09	
● 2750839	32	100	NR	10	09	

TUBO PIEGHEVOLE



codice	∅	lungh. (cm)	UM	min. ord. conf.	cat.	prezzo (€)
● 2750841	26	30	NR	10	09	
● 2750842	30	30	NR	10	09	
● 2750844	32	25	NR	10	09	
● 2750843	32	30	NR	10	09	

TUBO ECCENTRICO



codice	sigla	∅	lungh. (cm)	UM	min. ord. conf.	cat.	prezzo (€)
● 2651028	--92.300.4.	26	30	NR	10	09	
● 2750871	-	30	30	NR	5	09	
● 2750872	-	32	30	NR	5	09	

CURVA 90° LISCIA



codice	∅	lungh. (cm)	UM	min. ord. conf.	cat.	prezzo (€)
● 2651016	30	15x25	NR	5	09	
● 2651017	30	20x30	NR	5	09	

TUBO A GOMITO



codice	∅	lungh. (cm)	UM	min. ord. conf.	cat.	prezzo (€)
● 2750881	30	26	NR	5	09	

PROLUNGA CON O-RING



codice	∅	lungh. (cm)	UM	min. ord. conf.	cat.	prezzo (€)
● 2651001	26	13	NR	10	09	
● 2651003	30	13	NR	10	09	
● 2651002	32	13	NR	10	09	

GIUNZIONE CON 2 O-RING



codice	∅	UM	min. ord. conf.	cat.	prezzo (€)
● 2661049	26	NR	10	09	
● 2661050	30	NR	10	09	
● 2661051	32	NR	10	09	

SIFONAME

TUBI CROMATI IN OTTONE

GIUNZIONE RIDOTTA CON 2 O-RING



codice	∅	UM	min. ord. conf.	cat.	prezzo (€)
● 2661053	32x26	NR	10	09	
● 2661054	40x32	NR	10	09	

TUBO ORLATO CON GHIERA



codice	∅	lung. (cm)	UM	min. ord. conf.	cat.	prezzo (€)
● 2651039	1"1/4x26	25	NR	10	09	

TUBO ORLATO CON ATTACCO LAVATRICE



codice	sigla	∅	lung. (cm)	UM	min. ord. conf.	cat.	prezzo (€)
● 2651033	--97.205.5.	1"1/4x32	20	NR	10	09	

TUBO CON AERATORE



codice	sigla	∅	lung. (cm)	UM	min. ord. conf.	cat.	prezzo (€)
● 2651005	-159.250.5.	32	25	NR	1	09	

TUBI CROMATI IN ABS

TUBO LISCIO ABS CROMO



codice	∅	lung. (cm)	UM	min. ord. conf.	cat.	prezzo (€)
● 2651081	32	25	NR	10	09	
● 2651082	32	30	NR	10	09	

TUBO ORLATO ABS CROMO

Cond dado e guarnizione.



codice	∅	lung. (cm)	UM	min. ord. conf.	cat.	prezzo (€)
● 2651080	1"1/4x32	30	NR	10	09	

TUBO ESTENSIBILE

Estensibilità 30-80 cm.
Ghiera metallica e rosone in plastica (2651042 senza rosone)



codice	Ø	UM	min. ord. conf.	cat.	prezzo (€)
● 2651044	1"x26	NR	1	23	
● 2651045	1"x32	NR	1	23	
● 2651042	1"1/4x32/40	NR	1	20	

TUBO ESTENSIBILE

Estensibilità 45-78 cm.
Ghiera in PP



codice	sigla	Ø	UM	min. ord. conf.	cat.	prezzo (€)
● 2651036	-485.906.5.	1"1/4x32	NR	30	30	20
● 2651037	-485.906.6.	1"1/2x40	NR	1	30	20

DADO ESAGONALE OTTONE CROMATO



codice	sigla	Ø	UM	min. ord. conf.	cat.	prezzo (€)
● 2661001	-114.000.4.	1"	NR	10	20	
● 2661002	-114.000.5.	1"1/4	NR	10	20	

RIDUZIONE FILETTATA IN PP



codice	sigla	Ø	UM	min. ord. conf.	cat.	prezzo (€)
● 2661027	-252.006.5.	F 1"1/4 x M 1"	NR	10	20	
● 2661028	-252.006.6.	F 1"1/2 x M 1"1/4	NR	10	20	

RIDUZIONE FILETTATA OTTONE CROMATO



codice	sigla	Ø	UM	min. ord. conf.	cat.	prezzo (€)
● 2661029	--52.006.5.	F 1"1/4 x M 1"	NR	10	20	
● 2661030	--52.006.6.	F 1"1/2 x M 1"1/4	NR	10	20	

RIDUZIONE FILETTATA IN PP



codice	sigla	Ø	UM	min. ord. conf.	cat.	prezzo (€)
● 2661100	-252.005.5.	F 1" x M 1"1/4	NR	10	20	
● 2661084	-252.005.6.	F 1"1/4 x M 1"1/2	NR	10	20	

TUBO IN PP

Tubo D. 40 con ghiera, 2 attacchi lavatrice.
In dotazione riduzione invisibile 1"1/2 x 1"1/4



codice	sigla	Ø	lung. (mm)	UM	min. ord. conf.	cat.	prezzo (€)
● 2501001	-297.116.6.	1"1/4-1"1/2	170	NR	10	20	

TUBO IN PP

Tubo D. 32 con ghiera, 1 attacco lavatrice.
In dotazione riduzione invisibile 1"1/2 - 1"1/4.



codice	sigla	Ø	lung. (mm)	UM	min. ord. conf.	cat.	prezzo (€)
● 2661103	-297.219.5.	1"1/4-1"1/2	200	NR	10	20	

PROLUNGA BIVALENTE IN PP

Con attacco lavatrice e tappo di chiusura. Utilizzabile anche come raccordo lavatrice non sifonato



NOVITÀ!

codice	sigla	Ø	lung. (mm)	UM	min. ord. conf.	cat.	prezzo (€)
● 2502003	2103.322.6.	40	230	NR	10	20	

PROLUNGA CURVA IN PP

Curva a 90°, con ghiera e guarnizione



NOVITÀ!

codice	sigla	Ø	lung. (mm)	UM	min. ord. conf.	cat.	prezzo (€)
● 2502101	2104.322.6.	1"1/2x40	250	NR	10	20	

SIFONAME

ACCESSORI E RICAMBI SIFONAME

PROLUNGA IN PP

Con ghiera a stringere



codice	sigla	Ø (mm)	lung. (mm)	UM	min. ord. conf.	cat.	prezzo (€)
● 2502001	2100.322.6.	1"1/2x40	300	NR	10	20	

TUBO ORLATO CON GHIERA IN PP + GUARNIZIONE

Con ghiera filettata femmina



codice	sigla	Ø	lung. (mm)	UM	min. ord. conf.	cat.	prezzo (€)
● 2661057	-286.206.6.	1"1/2x40	200	NR	10	20	

CODOLO DIRITTO IN PeHD



codice	sigla	Ø	UM	min. ord. conf.	cat.	prezzo (€)
● 2661033	-251.253.5.	1"1/4x40	NR	10	20	

ANELLO SEPARATORE D.70, H.25 mm.

Con guarnizione, per pilette lavabi d'arredo sopra mobile. La sua funzione è quella di separare il lavabo dal piano del mobile. In ottone.

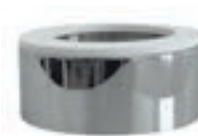

codice	sigla	UM	min. ord. conf.	cat.	prezzo (€)
● 2661094	--47.100.0.	NR	1	20	

TAPPO COPRENTE

Ricambio per piletta automatica 2106029.



codice	sigla	UM	min. ord. conf.	cat.	prezzo (€)
● 2661076	-137.036.0.	NR	1	10	20

TAPPO CESTELLO INOX PER PILETTA LAVELLO

Con guarnizione 2661059.



codice	sigla	Ø	UM	min. ord. conf.	cat.	prezzo (€)
● 2661058	-137.070.0.	80	NR	10	20	

TAPPO PILETTA LAVABO-BIDET PESANTE

Per piletta da 1"1/4



codice	Ø	UM	min. ord. conf.	cat.	prezzo (€)
● 2661011	40	NR	1	20	

TAPPO PILETTA LAVABO-BIDET BASE

Per piletta da 1"1/4



codice	Ø	UM	min. ord. conf.	cat.	prezzo (€)
● 3101012	40	NR	1	20	

TAPPO PILETTA LAVABO-BIDET

Per piletta da 1"1/4



codice	Ø	UM	min. ord.	conf.	cat.	prezzo (€)
● 2661095	40	NR	1	10	20	

TAPPO COPRENTE CLICKER

Con sistema clicker per sostituzione tappo su vecchie pilette da 1"1/4.



codice	sigla	Ø	UM	min. ord. conf.	cat.	prezzo (€)
● 2661097	8120.378.5	63	NR	10	20	

SNODINO DOPPIO



codice	materiale	UM	min. ord.	conf.	cat.	prezzo (€)
● 2750660	ottone nichelato	NR	1	50	20	

VITE PILETTA PROLUNGATA H.65 mm.

In sostituzione alla vite in dotazione (H. 30 mm) nelle pilette livello. 2201001 e 2201101.



codice	sigla	UM	min. ord. conf.	cat.	prezzo (€)
● 2661061	-137.072.0.	NR	10	20	

RACCORDO PP ECCENTRICO

Spostamento 3 cm.



codice	sigla	Ø	UM	min. ord. conf.	cat.	prezzo (€)
● 2661104	-292.155.5.	32x40	NR	10	20	

GUARNIZIONE TAPPO CESTELLO

Guarnizione di ricambio per tappo 2661058



codice	sigla	UM	min. ord. conf.	cat.	prezzo (€)
● 2661059	-137.070.9	NR	10	20	

SIFONE A SECCO PER SIFOIDE

Con sistema clapet per sifoide a pavimento 2403401, 2403402.

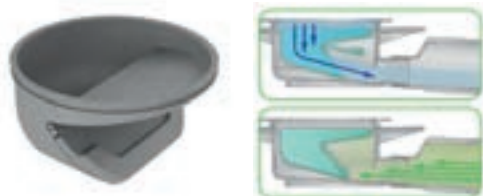

codice	sigla	UM	min. ord. conf.	cat.	prezzo (€)
● 2661099	-137.013.0.	NR	1	20	

GRIGLIA COPRENTE ABS CROMO

Ricambio per sifone piatto doccia 2303007 e 2303008



codice	sigla	UM	min. ord. conf.	cat.	prezzo (€)
● 2661106	-119.522.0.	NR	1	10	20

RUBINETTERIA SOTTOLAVABO, LAVATRICE E VARIA

RUBINETTI SOTTOLAVABO A SFERA

RUBINETTO SFERA CON FILTRO, CON SNODO CALOTTA BASSA



codice	sigla	attacco muro	calotta Ø	UM	min. ord.	conf.	cat.	prezzo (€)
● 2730203	0360B40ECR	1/2"	10	NR	2	50	06	

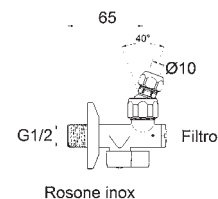

RUBINETTO SFERA CON FILTRO, CON SNODO CALOTTA ALTA



codice	sigla	attacco muro	uscita	battuta	calotta Ø	UM	min. ord.	conf.	cat.	prezzo (€)
● 2730217	0361A40ECR	1/2"	1/2"	piana	10	NR	50	06		

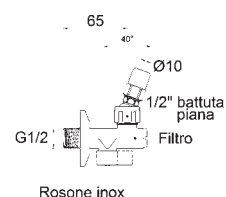

RUBINETTO SFERA CON FILTRO CALOTTA BASSA



codice	sigla	attacco muro	uscita	battuta	calotta Ø	UM	min. ord.	conf.	cat.	prezzo (€)
● 2730213	0350B40ECR	1/2"	3/8"	piana	10	NR	2	100	06	

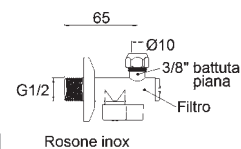

RUBINETTO SFERA CON FILTRO CALOTTA ALTA



codice	sigla	attacco muro	uscita	battuta	calotta Ø	UM	min. ord.	conf.	cat.	prezzo (€)
● 2730214	0350A40ECR	1/2"	3/8"	piana	10	NR	2	100	06	

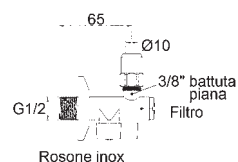

RUBINETTO SFERA CON FILTRO SENZA CALOTTA



codice	sigla	finitura	attacco muro	uscita	battuta	UM	min. ord.	conf.	cat.	prezzo (€)
● 2730216	0350040ECR	cromo	1/2"	3/8"	piana	NR	100	06		
● 2739216	03500401VE	nero opaco	1/2"	3/8"	piana	NR	2	06		

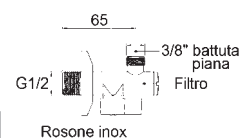

RUBINETTERIA SOTTOLAVABO, LAVATRICE E VARIA

RUBINETTI SOTTOLAVABO A VITONE

RUBINETTO VITONE CON FILTRO, CON SNODO CALOTTA BASSA

Corpo lungo cm. 8



codice	sigla	attacco muro	calotta Ø	UM	min. ord.	conf.	cat.	prezzo (€)
● 2730223	0417B400CR	1/2"	10	NR	2	50	06	

RUBINETTO VITONE CON FILTRO, CON SNODO CALOTTA BASSA

Corpo lungo cm. 8, battuta piana

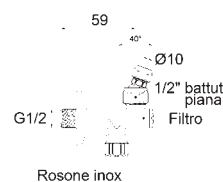

codice	sigla	attacco muro	uscita	battuta	calotta Ø	UM	min. ord.	conf.	cat.	prezzo (€)
● 2730225	0418B400CR	1/2"	1/2"	piana	10	NR	2	50	06	

RUBINETTO VITONE CON FILTRO SENZA CALOTTA

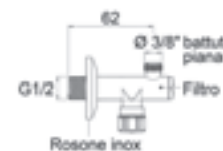

codice	sigla	attacco muro	uscita	battuta	UM	min. ord.	conf.	cat.	prezzo (€)
● 2730261	04140400CR	1/2"	3/8"	piana	NR	100	06		

RUBINETTO VITONE SENZA FILTRO CALOTTA BASSA

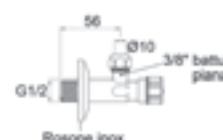

codice	sigla	attacco muro	uscita	battuta	calotta Ø	UM	min. ord.	conf.	cat.	prezzo (€)
● 2730281	0500B400ECR	1/2"	3/8"	piana	10	NR	2	100	06	

RUBINETTO VITONE SENZA FILTRO CALOTTA ALTA



codice	sigla	attacco muro	uscita	battuta	calotta Ø	UM	min. ord.	conf.	cat.	prezzo (€)
● 2730282	0500A400CR	1/2"	3/8"	piana	10	NR	2	100	06	

RUBINETTO VITONE SENZA FILTRO SENZA CALOTTA

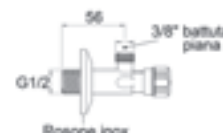

codice	sigla	attacco muro	uscita	battuta	UM	min. ord.	conf.	cat.	prezzo (€)
● 2730283	05000400ECR	1/2"	3/8"	piana	NR	2	100	06	

COMPLEMENTI SANITARI

RUBINETTERIA SOTTOLAVABO, LAVATRICE E VARIA

CURVETTE SOTTOLAVABO

CURVETTA ESAGONALE 45° STAMPATA CALOTTA BASSA



codice	sigla	attacco muro	uscita	battuta	calotta Ø	UM	min. ord.	conf.	cat.	prezzo (€)
● 2731101	0150B400CR	1/2"	3/8"	piana	10	NR	2	100	06	

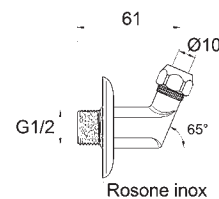

CURVETTA ESAGONALE 45° STAMPATA SENZA CALOTTA



codice	sigla	attacco muro	uscita	UM	min. ord.	conf.	cat.	prezzo (€)
● 2731105	01500400CR	1/2"	3/8"	NR	2	100	06	

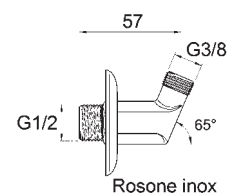

CURVETTA 90° STAMPATA CALOTTA BASSA



codice	sigla	attacco muro	uscita	battuta	calotta Ø	UM	min. ord.	conf.	cat.	prezzo (€)
● 2731106	0160SB400CR	1/2"	3/8"	piana	10	NR	2	100	06	

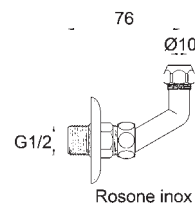

CURVETTA 90° IN TUBO DI RAME CROMATO CALOTTA BASSA



codice	sigla	attacco muro	uscita	battuta	calotta Ø	UM	min. ord.	conf.	cat.	prezzo (€)
● 2731102	0160B400CR	1/2"	3/8"	piana	10	NR	2	100	06	

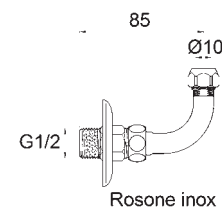

CURVETTA SNODATA CALOTTA BASSA



codice	sigla	attacco muro	uscita	battuta	calotta Ø	UM	min. ord.	conf.	cat.	prezzo (€)
● 2731103	0172B400CR	1/2"	3/8"	piana	10	NR	2	100	06	

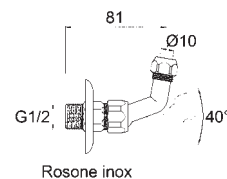

RUBINETTERIA SOTTOLAVABO, LAVATRICE E VARIA

RUBINETTI PER CASSETTA WC

RUBINETTO MASCHIO PER CASSETTA WC

Chiusura a vitone con codolo e calotta girevole



codice	sigla	attacco Ø	UM	min. ord.	conf.	cat.	prezzo (€)
● 2733002	0500C300CR	3/8"x3/8"	NR	1	50	06	
● 2733001	0500C400CR	1/2"x3/8"	NR	1	50	06	

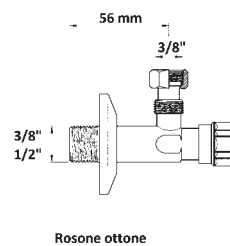

RUBINETTO FEMMINA PER CASSETTA WC

Chiusura a vitone con codolo e calotta girevole



codice	sigla	attacco Ø	UM	min. ord.	conf.	cat.	prezzo (€)
● 2733000	0509C300CR	3/8"x3/8"	NR	1	50	06	

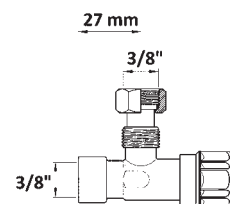

RUBINETTO MASCHIO PER CASSETTA WC CON TUBO

Chiusura a vitone con tubetto in rame cromato D.10



codice	sigla	attacco Ø	UM	min. ord.	conf.	cat.	prezzo (€)
● 2733003	05050300CR	3/8"x3/8"	NR	1	25	06	
● 2733004	05050400CR	1/2"x3/8"	NR	1	25	06	

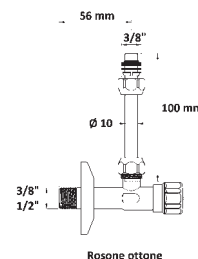

RUBINETTO MASCHIO PER CASSETTA WC CON TUBI

Chiusura a vitone, con tubetti in rame cromato D.10 lunghi 15 cm



codice	sigla	attacco Ø	UM	min. ord.	conf.	cat.	prezzo (€)
● 2733005	05070300CR	3/8"x3/8"	NR	1	20	06	

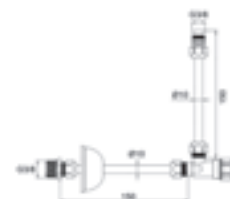

RACCORDI PER SCALDABAGNO

RACCORDI PER SCALDABAGNO

Con tubi e squadretta in rame cromato, biconi D. 14



codice	sigla	attacco Ø	UM	min. ord.	conf.	cat.	prezzo (€)
● 2733010	0905R442CR	1/2"x1/2"	NR	1	06		



COMPLEMENTI
SANITARI

RUBINETTERIA SOTTOLAVABO, LAVATRICE E VARIA

LAVATRICE E SOTTOLAVELLO

RUBINETTO 5 VIE SENZA FILTRO



Chiusure a vitoni indipendenti

codice	sigla	attacco Ø	calotta Ø	UM	min. ord.	conf.	cat.	prezzo (€)
● 2730251	0550S400CR	1/2"x3/4"	10	NR	1	50	06	

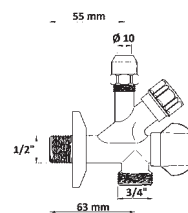

RUBINETTO 5 VIE CON FILTRO



Chiusure a vitoni indipendenti

codice	sigla	attacco Ø	calotta Ø	UM	min. ord.	conf.	cat.	prezzo (€)
● 2730252	0551B400CR	1/2"x3/4"	10	NR	1	50	06	

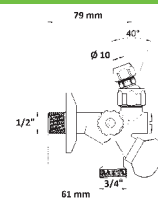

RUBINETTO LAVATRICE CHIUSURA A SFERA



codice	sigla	attacco Ø	UM	min. ord.	conf.	cat.	prezzo (€)
● 2732005	05550300CR	3/8"x3/4"	NR	1	100	06	
● 2732001	05550400CR	1/2"x3/4"	NR	100	100	06	

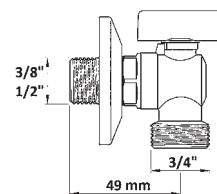

RUBINETTO LAVATRICE CHIUSURA A SFERA CORPO LUNGO



codice	sigla	attacco Ø	UM	min. ord.	conf.	cat.	prezzo (€)
● 2732008	0552L400CR	1/2"x3/4"	NR	1	50	06	

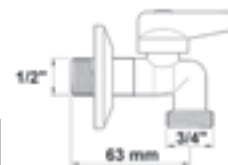

RUBINETTO LAVATRICE CHIUSURA A VITONE



codice	sigla	attacco Ø	UM	min. ord.	conf.	cat.	prezzo (€)
● 2732004	05580400CR	1/2"x3/4"	NR	1	100	06	

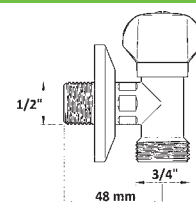

RUBINETTO LAVATRICE 3 VIE, CHIUSURA A VITONE



codice	sigla	attacco Ø	UM	min. ord.	conf.	cat.	prezzo (€)
● 2732003	05590400CR	1/2"x3/4"	NR	1	100	06	

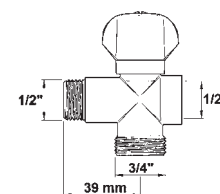

RUBINETTO LAVATRICE 3 VIE CON DISTANZIATORE



codice	sigla	attacco Ø	UM	min. ord.	conf.	cat.	prezzo (€)
● 2732006	05540500CR	3/4"x3/4"	NR	1	50	06	

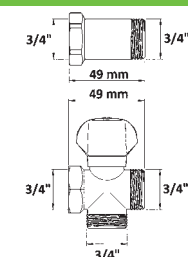

TUBO CARICO LAVATRICE

Tubo flessibile DN 13 in acciaio inox AISI 304 con raccordi femmina e guarnizioni inserite. Temperatura 90°C. Pressione max 10 bar



codice	∅	lunghezza (mm)	UM	min. ord. conf.	cat.	prezzo (€)
● 2862914	3/4"	1500	NR	1	06	
● 2862915	3/4"	2000	NR	1	06	

TUBO CARICO LAVATRICE CON CURVA

Tubo DN 8 in acciaio inox femmina e femmina curva con guarnizione inserita in entrambi i lati. Temperatura 70°C. Pressione max 10 bar



codice	sigla	∅	lungh. (mm)	UM	min. ord. conf.	cat.	prezzo (€)
● 2862701	CGGHZS1000LAN	3/4"	1000	NR	10	06	
● 2862702	CGGHZS1500LAN	3/4"	1500	NR	10	06	
● 2862703	CGGHZS2000LAN	3/4"	2000	NR	10	06	

TUBO CARICO LAVATRICE

Tubo DN 10 in nylon con guarnizione inserita in entrambi i lati



codice	∅	lunghezza (mm)	UM	min. ord. conf.	cat.	prezzo (€)
● 2880001	FF 3/4"	1000	NR	1	09	
● 2880002	FF 3/4"	1500	NR	1	09	
● 2880003	FF 3/4"	2000	NR	1	09	
● 2880005	FF 3/4"	3000	NR	1	09	

TUBO CARICO LAVATRICE CON CURVA

Tubo DN 10 in nylon con guarnizione inserita in entrambi i lati



codice	∅	lunghezza (mm)	UM	min. ord. conf.	cat.	prezzo (€)
● 2881001	FF 3/4"	1000	NR	1	09	
● 2881002	FF 3/4"	1500	NR	1	09	
● 2881003	FF 3/4"	2000	NR	1	09	
● 2881004	FF 3/4"	2500	NR	1	09	

TUBO SCARICO LAVATRICE

In polipropilene con curva, tubo D.19x25, manicotti D.19x22



codice	∅	lunghezza (mm)	UM	min. ord. conf.	cat.	prezzo (€)
● 2882001	19x25	1000	NR	1	09	
● 2882002	19x25	1500	NR	1	09	
● 2882003	19x25	2000	NR	1	09	
● 2882004	19x25	2500	NR	1	09	
● 2882005	19x25	3000	NR	1	09	

TUBO CARICO LAVATRICE CON ACQUASTOP

Tubo in PVC con parte esterna corrugata in polipropilene, raccordi in nylon con fibra di vetro.



Pressione d'esercizio: 0,2 - 10 bar
Pressione di scoppio: > 60 bar
Temperatura di utilizzo: max 80°C

codice	∅	lunghezza (mm)	UM	min. ord. conf.	cat.	prezzo (€)
● 2883101	FF 3/4"	1000	NR	1	09	
● 2883102	FF 3/4"	1500	NR	1	09	
● 2883103	FF 3/4"	2000	NR	1	09	

TUBO SCARICO LAVATRICE ESTENSIBILE

Con morsetti in gomma. Passaggio D. 19



codice	sigla	lunghezza (mm)	UM	min. ord. conf.	cat.	prezzo (€)
● 2883001	-485.309.6.	700-3000	NR	1	20	

SIFONE AD INCASSO PER LAVATRICE

In PeHD, con protezione



RICAMBI (PAG. 180)
2661013 - Piastra inox
2661014 - Piastra ABS
2661017 - Curvetta

codice	attacco ∅	piastra	UM	min. ord.	conf.	cat.	prezzo (€)
● 2401201	1"x40-50	acciaio inox	NR	1	30	02	
● 2401301	1"x40-50	ABS bianca	NR	1	30	02	



RUBINETTERIA SOTTOLAVABO, LAVATRICE E VARIA

LAVATRICE E SOTTOLAVELLO

SIFONE ESTERNO PER LAVATRICE



In ottone cromato, ispezionabile.

codice	sigla	attacco Ø	UM	min. ord.	conf.	cat.	prezzo (€)
● 2401305	93733400	32	NR	2	20	02	

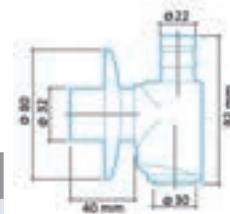

VALVOLA ESTERNA PER LAVATRICE



In PP. Con molla antiritorno che permette alla valvola di funzionare in tutte le posizioni.

codice	sigla	attacco Ø	UM	min. ord. conf.	cat.	prezzo (€)
● 2401304	2108.180.5.	32	NR	10	02	



CURVETTA IN ABS ATTACCO LAVATRICE CURVO

Con ghiera e guarnizione



codice	Ø	UM	min. ord. conf.	cat.	prezzo (€)
● 2661086	1"	NR	10	20	

CURVETTA IN PP ATTACCO LAVATRICE CURVO



codice	sigla	Ø	UM	min. ord. conf.	cat.	prezzo (€)
● 2661017	2111.100.4.	1"	NR	10	20	

PIPA CON GHIERA GIREVOLE IN PVC



codice	Ø	UM	min. ord. conf.	cat.	prezzo (€)
● 2661091	3/4"x3/4"	NR	10	23	

ATTACCO DOPPIO X TUBO CARICO LAVATRICE



codice	Ø	UM	min. ord. conf.	cat.	prezzo (€)
● 2661092	3/4" F x 3/4" M x 3/4" M	NR	10	20	

NIPPLE IN ABS



codice	Ø	UM	min. ord. conf.	cat.	prezzo (€)
● 2661087	3/4"	NR	10	23	

GIUNTO PER TUBO



codice	Ø	UM	min. ord. conf.	cat.	prezzo (€)
● 2661089	17x17	NR	1	23	
● 2661090	17x22	NR	1	23	
● 2661088	22x22	NR	1	23	

GIUNTO A DUE VIE X TUBO SCARICO LAVATRICE



codice	Ø	UM	min. ord. conf.	cat.	prezzo (€)
● 2661093	20x20x20	NR	10	20	

PIASTRA PER SIFONE LAVATRICE AD INCASSO



codice	sigla	descrizione	UM	min. ord. conf.	cat.	prezzo (€)
● 2661013	-137.074.0.	Inox	NR	10	20	
● 2661014	-137.075.0.	ABS bianca	NR	10	20	

FLESSIBILI ACQUA E ANTIVIBRANTI

FLESSIBILI RUBINETTERIA

Tubi flessibili in acciaio inox AISI 304, tubo interno in EPDM, raccordi in ottone.
Temperatura max 70°C. Pressione max 10 bar.

FLESSIBILE MASCHIO CORTO

Con maschio corto e femmina girevole, con guarnizione inserita.
APPLICAZIONE: Rubinetti tradizionali, rubinetti miscelatori.



codice	sigla	DN	FGI	MC	mm	UM	min. ord. conf.	cat.	prezzo (€)
● 2870011	-	6	3/8"	8x1	350	NR	25	06	
● 2870003	CGAKLS0300LAL	8	3/8"	10x1	300	NR	25	06	
● 2870004	-	8	3/8"	10x1	350	NR	25	06	
● 2870005	CGAKLS0400LAE	8	3/8"	10x1	400	NR	10	06	
● 2870006	CGAKLS0500LAE	8	3/8"	10x1	500	NR	10	06	
● 2870012	-	8	3/8"	11x1	350	NR	25	06	
● 2870013	-	8	3/8"	12x1	350	NR	25	06	

FLESSIBILE RACCORDO A COMPRESSIONE

Con raccordo a compressione con cartuccia 3 pezzi e astina con scalino
APPLICAZIONE: Rubinetti tradizionali, rubinetti miscelatori.



codice	sigla	TS	RCC	mm	UM	min. ord. conf.	cat.	prezzo (€)
● 2872002	CGA3GS0250LAL	10	10	250	NR	25	06	

FLESSIBILE MASCHIO MEDIO

Con maschio medio e femmina girevole, con guarnizione inserita.
APPLICAZIONE: Rubinetti tradizionali, rubinetti miscelatori.



codice	sigla	FGI	MM	mm	UM	min. ord. conf.	cat.	prezzo (€)
● 2873004	CGASES0350LAL	3/8"	10x1	350	NR	25	06	
● 2873005	CGASES0400LAE	3/8"	10x1	400	NR	10	06	

FLESSIBILI ACQUA DN8

FLESSIBILE FEMMINA RACCORDO A COMPRESSIONE

Con raccordo femmina e raccordo a compressione con cartuccia a 3 pezzi, con guarnizione inserita.
APPLICAZIONE: Cassette di scarico, caldaie, installazioni generiche.



codice	sigla	FGI	RCC	mm	UM	min. ord. conf.	cat.	prezzo (€)
● 2804503	CGANWS0300LAL	3/8"	10	300	NR	25	06	

FLESSIBILE FEMMINA - FEMMINA

Con raccordo femmina girevole, con guarnizione inserita, in entrambi i lati.
APPLICAZIONE: Cassette di scarico, caldaie, installazioni generiche.



codice	sigla	FGI	FGI	mm	UM	min. ord. conf.	cat.	prezzo (€)
● 2801102	CGAGUS0250LAL	3/8"	3/8"	250	NR	25	06	
● 2801103	CGAGUS0300LAL	3/8"	3/8"	300	NR	25	06	
● 2801104	CGAGUS0350LAL	3/8"	3/8"	350	NR	25	06	

FLESSIBILE FEMMINA - FEMMINA CURVA

Con femmina e femmina curva con guarnizione inserita.
APPLICAZIONE: Lavatrice, lavastoviglie.



codice	sigla	FGI	FCGI	mm	UM	min. ord. conf.	cat.	prezzo (€)
● 2862701	CGGHZS1000LAN	3/4"	3/4"	1000	NR	10	06	
● 2862702	CGGHZS1500LAN	3/4"	3/4"	1500	NR	10	06	
● 2862703	CGGHZS2000LAN	3/4"	3/4"	2000	NR	10	06	

FLESSIBILE MASCHIO PROLUNGATO RACCORDO A COMPRESSIONE

Con raccordo maschio prolungato e raccordo a compressione con cartuccia 3 pezzi.
APPLICAZIONE: Cassette di scarico, caldaie, installazioni generiche.



codice	sigla	MP	RCC	mm	UM	min. ord. conf.	cat.	prezzo (€)
● 2804201	CGAQPS0200LAL	1/2"	10	200	NR	25	06	
● 2804202	CGAQPS0250LAL	1/2"	10	250	NR	25	06	
● 2804203	CGAQPS0300LAL	1/2"	10	300	NR	25	06	
● 2804204	CGAQPS0350LAL	1/2"	10	350	NR	25	06	
● 2804205	CGAQPS0400LAE	1/2"	10	400	NR	10	06	

LEGENDA

F: FEMMINA GUARNIZIONE INSERITA

FCGI: FEMMINA CURVA GUARNIZIONE INSERITA

FGI: FEMMINA GUARNIZIONE INSERITA CON DADO GIREVOLE

M: MASCHIO

MC: MASCHIO CORTO

MM: MASCHIO MEDIO

MP: MASCHIO PROLUNGATO

MPR: MASCHIO PROLUNGATO CON ROSETTA

RCC: RACCORDO A COMPRESSIONE

TS: DIAMETRO ASTINA CON SCALINO

FLESSIBILI ACQUA E ANTIVIBRANTI

FLESSIBILI ACQUA DN10

Tubi flessibili in acciaio inox AISI 304, tubo interno in EPDM, raccordi in ottone.
Temperatura max 70°C. Pressione max 10 bar.

FLESSIBILE FEMMINA - FEMMINA

Con raccordo femmina girevole, con guarnizione inserita in entrambi i lati.

APPLICAZIONE: Cassette di scarico, caldaie, installazioni generiche.



codice	sigla	FGI	FGI	mm	UM	min. ord. conf.	cat.	prezzo (€)
● 2811101	-	3/8"	3/8"	200	NR	25	06	
● 2811102	-	3/8"	3/8"	250	NR	25	06	
● 2811103	-	3/8"	3/8"	300	NR	25	06	
● 2811104	FGAGUS0350LAL	3/8"	3/8"	350	NR	25	06	
● 2811105	FGAGUS0400LAE	3/8"	3/8"	400	NR	10	06	
● 2811106	FGAGUS0500LAE	3/8"	3/8"	500	NR	10	06	
● 2811201	FGAGNS0200LAL	1/2"	3/8"	200	NR	25	06	
● 2811202	FGAGNS0250LAL	1/2"	3/8"	250	NR	25	06	
● 2811203	-	1/2"	3/8"	300	NR	25	06	
● 2811204	FGAGNS0350LAL	1/2"	3/8"	350	NR	25	06	
● 2811205	FGAGNS0400LAE	1/2"	3/8"	400	NR	10	06	
● 2811301	FGAGKS0200LAL	1/2"	1/2"	200	NR	25	06	
● 2811302	FGAGKS0250LAL	1/2"	1/2"	250	NR	25	06	
● 2811303	-	1/2"	1/2"	300	NR	25	06	
● 2811304	FGAGKS0350LAL	1/2"	1/2"	350	NR	25	06	
● 2811305	FGAGKS0400LAE	1/2"	1/2"	400	NR	10	06	
● 2811306	FGAGKS0500LAE	1/2"	1/2"	500	NR	10	06	
● 2811309	FGAGKS1000LAE	1/2"	1/2"	1000	NR	10	06	

FLESSIBILE MASCHIO PROLUNGATO CON ROSETTA - FEMMINA

Con raccordo maschio prolungato con rosetta scorrevole e raccordo femmina girevole, con guarnizione inserita.

APPLICAZIONE: Cassette di scarico, caldaie, installazioni generiche.



codice	sigla	MPR	FGI	mm	UM	min. ord. conf.	cat.	prezzo (€)
● 2812101	-	3/8"	3/8"	200	NR	25	06	
● 2812102	-	3/8"	3/8"	250	NR	25	06	
● 2812103	-	3/8"	3/8"	300	NR	25	06	
● 2812104	FGADJ0350LAR	3/8"	3/8"	350	NR	25	06	
● 2812105	FGADJ0400LAS	3/8"	3/8"	400	NR	10	06	
● 2812106	FGADJ0500LAS	3/8"	3/8"	500	NR	10	06	
● 2812302	FGADES0250LAR	1/2"	3/8"	250	NR	25	06	
● 2812303	FGADES0300LAR	1/2"	3/8"	300	NR	25	06	
● 2812305	FGADES0400LAS	1/2"	3/8"	400	NR	10	06	
● 2812401	FGADDS0200LAR	1/2"	1/2"	200	NR	25	06	
● 2812402	-	1/2"	1/2"	250	NR	25	06	
● 2812403	-	1/2"	1/2"	300	NR	25	06	
● 2812404	-	1/2"	1/2"	350	NR	25	06	
● 2812405	-	1/2"	1/2"	400	NR	10	06	
● 2812406	FGADDS0500LAS	1/2"	1/2"	500	NR	10	06	
● 2812409	-	1/2"	1/2"	1000	NR	10	06	

FLESSIBILE MASCHIO - FEMMINA

Con raccordo maschio e raccordo femmina girevole, con guarnizione inserita.

APPLICAZIONE: Cassette di scarico, caldaie, installazioni generiche.



codice	sigla	M	FGI	mm	UM	min. ord. conf.	cat.	prezzo (€)
● 2810101	-	3/8"	3/8"	200	NR	25	06	
● 2810102	-	3/8"	3/8"	250	NR	25	06	
● 2810103	-	3/8"	3/8"	300	NR	25	06	
● 2810104	-	3/8"	3/8"	350	NR	25	06	
● 2810105	-	3/8"	3/8"	400	NR	10	06	
● 2810106	FGACFS0500LAE	3/8"	3/8"	500	NR	10	06	
● 2810107	FGACFS0600LAE	3/8"	3/8"	600	NR	10	06	
● 2810109	FGACFS1000LAE	3/8"	3/8"	1000	NR	10	06	
● 2810201	FGACDS0200LAL	3/8"	1/2"	200	NR	25	06	
● 2810202	FGACDS0250LAL	3/8"	1/2"	250	NR	25	06	
● 2810203	FGACDS0300LAL	3/8"	1/2"	300	NR	25	06	
● 2810204	FGACDS0350LAL	3/8"	1/2"	350	NR	25	06	
● 2810205	FGACDS0400LAE	3/8"	1/2"	400	NR	10	06	
● 2810206	FGACDS0500LAE	3/8"	1/2"	500	NR	10	06	
● 2810301	FGAAVS0200LAL	1/2"	3/8"	200	NR	25	06	
● 2810302	FGAAVS0250LAL	1/2"	3/8"	250	NR	25	06	
● 2810303	FGAAVS0300LAL	1/2"	3/8"	300	NR	25	06	
● 2810304	FGAAVS0350LAL	1/2"	3/8"	350	NR	25	06	
● 2810305	FGAAVS0400LAE	1/2"	3/8"	400	NR	10	06	
● 2810401	-	1/2"	1/2"	200	NR	25	06	
● 2810402	-	1/2"	1/2"	250	NR	25	06	
● 2810403	-	1/2"	1/2"	300	NR	25	06	
● 2810404	-	1/2"	1/2"	350	NR	25	06	
● 2810405	-	1/2"	1/2"	400	NR	10	06	
● 2810406	-	1/2"	1/2"	500	NR	10	06	
● 2810407	FGAASS0600LAE	1/2"	1/2"	600	NR	10	06	
● 2810408	FGAASS0800LAE	1/2"	1/2"	800	NR	10	06	
● 2810409	-	1/2"	1/2"	1000	NR	10	06	

FLESSIBILE MASCHIO PROLUNGATO RACCORDO A COMPRESIONE

Con raccordo maschio prolungato e raccordo a compressione con cartuccia a 3 pezzi.

APPLICAZIONE: Cassette di scarico, caldaie, installazioni generiche.



codice	sigla	MP	RCC	mm	UM	min. ord. conf.	cat.	prezzo (€)
● 2814202	FGAQPS0250LAL	1/2"	10	250	NR	25	06	
● 2814203	-	1/2"	10	300	NR	25	06	
● 2814204	FGAQPS0350LAL	1/2"	10	350	NR	25	06	

LEGENDA

F: FEMMINA GUARNIZIONE INSERITA
FCGI: FEMMINA CURVA GUARNIZIONE INSERITA
FGI: FEMMINA GUARNIZIONE INSERITA CON DADO GIREVOLE

M: MASCHIO
MC: MASCHIO CORTO
MM: MASCHIO MEDIO
MP: MASCHIO PROLUNGATO

MPR: MASCHIO PROLUNGATO CON ROSETTA
RCC: RACCORDO A COMPRESIONE
TS: DIAMETRO ASTINA CON SCALINO

FLESSIBILI ACQUA E ANTIVIBRANTI

FLESSIBILI ACQUA DN10

FLESSIBILE FEMMINA RACCORDO A COMPRESSIONE

Con raccordo femmina e raccordo a compressione con cartuccia a 3 pezzi, con guarnizione.

APPLICAZIONE: Cassette di scarico, caldaie, installazioni generiche.



codice	sigla	FGI	RCC	mm	UM	min. ord. conf.	cat.	prezzo (€)
● 2814502	FGANWS0250LAL	3/8"	10	250	NR	25	06	
● 2814503	FGANWS0300LAL	3/8"	10	300	NR	25	06	

FLESSIBILE MASCHIO RACCORDO A COMPRESSIONE

Con raccordo maschio e raccordo a compressione con cartuccia a 3 pezzi.

APPLICAZIONE: Cassette di scarico, caldaie, installazioni generiche.



codice	sigla	M	RCC	mm	UM	min. ord. conf.	cat.	prezzo (€)
● 2815201	FGAQES0200LAL	1/2"	10	200	NR	25	06	
● 2815202	FGAQES0250LAL	1/2"	10	250	NR	25	06	
● 2815203	FGAQES0300LAL	1/2"	10	300	NR	25	06	

FLESSIBILI ACQUA DN13

FLESSIBILE MASCHIO - FEMMINA

Tubo flessibile in acciaio inox AISI 304 con raccordo maschio e raccordo femmina girevole, con guarnizione inserita.

Temperatura max 70°C. Pressione max 10 bar.

APPLICAZIONE: Scaldabagni, cabine doccia, vasche idromassaggio, fan coil, installazioni generiche.



codice	sigla	M	FGI	mm	UM	min. ord. conf.	cat.	prezzo (€)
● 2820102	MGAASS0250LAL	1/2"	1/2"	250	NR	25	06	
● 2820103	MGAASS0300LAL	1/2"	1/2"	300	NR	25	06	
● 2820105	MGAASS0400LAE	1/2"	1/2"	400	NR	10	06	

FLESSIBILE FEMMINA-FEMMINA

Tubo flessibile in acciaio inox AISI 304 con raccordi femmina e guarnizioni inserite.

Temperatura max 90°C. Pressione max 10 bar.

APPLICAZIONE: Lavatrice e lavastoviglie.



codice	FGI	mm	UM	min. ord. conf.	cat.	prezzo (€)
● 2862914	3/4"	1500	NR	1	06	
● 2862915	3/4"	2000	NR	1	06	

ANTIVIBRANTI

Tubi flessibili in acciaio zincato, tubo interno in EPDM.

Temperatura max 110°C. Pressione max 15 bar (DN 15-25), 6 bar (DN 32-50)

FLESSIBILI ANTIVIBRANTI ZINCATI MASCHIO-FEMMINA

Con raccordo maschio e raccordo femmina in ottone nichelato.

APPLICAZIONE: Pompe, Impianti di riscaldamento, colonne montanti, applicazioni generiche.



**RACCORDI
IN OTTONE**

codice	MF	DN	mm	UM	min. ord. conf.	cat.	prezzo (€)
● 2862101	1/2"	13	300	NR	5	21	
● 2862102	1/2"	13	400	NR	5	21	
● 2862103	1/2"	13	500	NR	5	21	
● 2862104	1/2"	13	600	NR	5	21	
● 2862106	1/2"	13	800	NR	5	21	
● 2862107	1/2"	13	1000	NR	5	21	
● 2862201	3/4"	19	300	NR	5	21	
● 2862202	3/4"	19	400	NR	5	21	
● 2862203	3/4"	19	500	NR	5	21	
● 2862204	3/4"	19	600	NR	5	21	
● 2862206	3/4"	19	800	NR	5	21	
● 2862207	3/4"	19	1000	NR	5	21	
● 2862301	1"	25	300	NR	5	21	
● 2862302	1"	25	400	NR	5	21	
● 2862303	1"	25	500	NR	5	21	
● 2862304	1"	25	600	NR	5	21	
● 2862306	1"	25	800	NR	5	21	
● 2862307	1"	25	1000	NR	5	21	

codice	MF	DN	mm	UM	min. ord. conf.	cat.	prezzo (€)
● 2862401	1"1/4	32	300	NR	2	21	
● 2862402	1"1/4	32	400	NR	2	21	
● 2862403	1"1/4	32	500	NR	2	21	
● 2862404	1"1/4	32	600	NR	2	21	
● 2862406	1"1/4	32	800	NR	2	21	
● 2862407	1"1/4	32	1000	NR	2	21	
● 2862502	1"1/2	40	400	NR	2	21	
● 2862503	1"1/2	40	500	NR	2	21	
● 2862504	1"1/2	40	600	NR	2	21	
● 2862602	2"	50	400	NR	1	21	
● 2862603	2"	50	500	NR	1	21	

LEGENDA

F: FEMMINA GUARNIZIONE INSERITA

FCGI: FEMMINA CURVA GUARNIZIONE INSERITA

FGI: FEMMINA GUARNIZIONE INSERITA CON DADO GIREVOLE

M: MASCHIO

MC: MASCHIO CORTO

MM: MASCHIO MEDIO

MP: MASCHIO PROLUNGATO

MPR: MASCHIO PROLUNGATO CON ROSETTA

RCC: RACCORDO A COMPRESSIONE

TS: DIAMETRO ASTINA CON SCALINO

SISTEMI DI FISSAGGIO

STAFFE PER SANITARI SOSPESI

STAFFA WC E BIDET SOSPESI MOD. UNIVERSALE



Sistema universale per vasi e bidet sospesi, con alloggiamento per tubo di cacciata. SMONTATA.

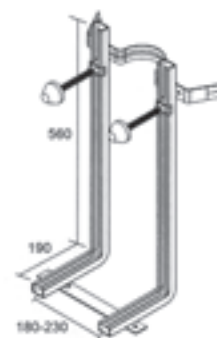

codice	interasse (mm)	UM	min. ord. conf.	cat.	prezzo (€)
● 5850002	180-230	NR	1	09	

STAFFA BIDET SOSPESO MOD. COMBI



codice	interasse (mm)	UM	min. ord. conf.	cat.	prezzo (€)
● 5850031	180-230	NR	1	09	

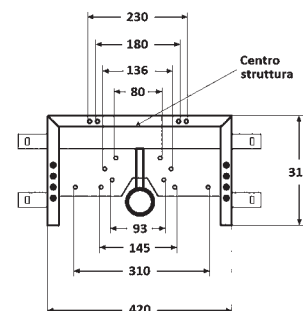

SUPPORTI E FISSAGGI

SUPPORTO REGOLABILE PER PILOZZI, VERNICIATO BIANCO

Confezione 2 pezzi



codice	dimensioni (mm)	tassello (mm)	UM	min. ord.	conf.	cat.	prezzo (€)
● 5863001	12x340	16x90	CF	1	10	09	
● 5863002	12x460	16x90	CF	1	10	09	

FISSAGGIO LATERALE WC E BIDET MULTIFORO

In nylon.
Confezione 2 pezzi



codice	tassello (mm)	UM	min. ord.	conf.	cat.	prezzo (€)
● 5863101	M10x50	CF	1	100	09	

FISSAGGIO VERTICALE WC E BIDET

Vite in acciaio inox, dado in ottone nichelato.
Confezione 4 pezzi



codice	dimensioni (mm)	tassello (mm)	UM	min. ord.	conf.	cat.	prezzo (€)
● 5863401	M6x80	8x40	CF	1	100	09	

FISSAGGIO LAVABO

Dado in acciaio, tassello doppia espansione.
Confezione 2 pezzi



codice	dimensioni (mm)	tassello (mm)	UM	min. ord.	conf.	cat.	prezzo (€)
● 5863201	M10x120	14x70	CF	1	50	09	

FISSAGGIO SCALDABAGNO E CALDAIA

Con tassello doppia espansione per pareti vuote.
Confezione 2 pezzi



codice	dimensioni (mm)	tassello (mm)	UM	min. ord.	conf.	cat.	prezzo (€)
● 5863301	M10x94	14x70	CF	1	50	09	

SANITRIT UP

Trituratore adattabile a tutti i wc tradizionali in ceramica.
A corredo: valvola clapet, kit di raccordo impianto e filtro a carboni attivi, per neutralizzare gli odori.



Applicazioni: WC

Capacità di scarico: 4 metri in verticale (tubo Ø 22/28/32 mm.)
100 metri in orizzontale (tubo Ø 28/32/40 mm.)

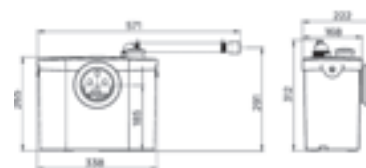

codice	sigla	Nr. entrate	Livello sonoro	UM	min. ord. conf.	cat.	prezzo (€)
● 3350100	STSUP	1	46 dB(A)	NR	1	13	

SANITOP UP

Trituratore adattabile a tutti i wc tradizionali in ceramica, con la possibilità di collegare anche un lavabo. A corredo: valvola clapet, kit di raccordo impianto e filtro a carboni attivi, per neutralizzare gli odori.



Applicazioni: WC - lavabo

Capacità di scarico: 5 metri in verticale (tubo Ø 22/28/32 mm.)
100 metri in orizzontale (tubo Ø 22/28/40 mm.)

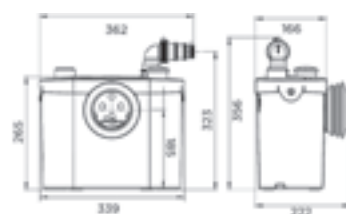

codice	sigla	Nr. entrate	Livello sonoro	UM	min. ord. conf.	cat.	prezzo (€)
● 3350060	SPSUP	2	46 dB(A)	NR	1	13	

SANISLIM

Trituratore con profondità ridotta, con la possibilità di collegare un bagno completo (escluso lavatrice). A corredo: valvola clapet, kit di raccordo impianto e filtro a carboni attivi, per neutralizzare gli odori.



Applicazioni: WC - lavabo - bidet - doccia

Capacità di scarico: 4 metri in verticale (tubo Ø 22/28/32 mm.)
40 metri in orizzontale (tubo Ø 22/28/32 mm.)

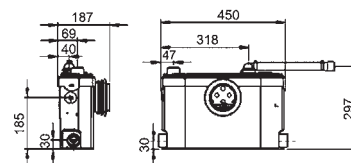

codice	sigla	Nr. entrate	Livello sonoro	UM	min. ord. conf.	cat.	prezzo (€)
● 3350080	SSL	4	46 dB(A)	NR	1	13	

SANIPLUS UP

Trituratore con ampio serbatoio, con la possibilità di collegare un bagno completo (escluso lavatrice). A corredo: valvola clapet, kit di raccordo impianto e filtro a carboni attivi, per neutralizzare gli odori.



Applicazioni: WC - lavabo - bidet - doccia

Capacità di scarico: 5 metri in verticale (tubo Ø 22/28/32 mm.)
100 metri in orizzontale (tubo Ø 28/32/40 mm.)

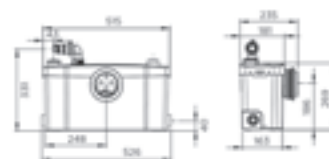

codice	sigla	Nr. entrate	Livello sonoro	UM	min. ord. conf.	cat.	prezzo (€)
● 3350090	SSSUP	4	46 dB(A)	NR	1	13	

TRITURATORI E POMPE SOLLEVAMENTO

TRITURATORI

SANIPACK PRO UP

Trituratore ad incasso per wc sospesi, con la possibilità di collegare un bagno completo (escluso lavatrice). A corredo: valvola clapet, connettori e filtro a carboni attivi, per neutralizzare gli odori.



Applicazioni: WC - WC sospeso - lavabo - bidet - doccia
Capacità di scarico: 5 metri in verticale (tubo Ø 22/28/32 mm.)
 100 metri in orizzontale (tubo Ø 28/32/40 mm.)

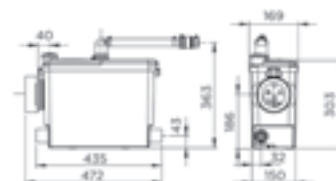

codice	sigla	Nr. entrate	Livello sonoro	UM	min. ord. conf.	cat.	prezzo (€)
● 3350050	SKUP	4	47 dB(A)	NR	1	13	

SANICOMPACT 43 SILENCE

WC in ceramica con trituratore incorporato, sedile antibatterico a chiusura rallentata. Non necessita di cassetta di scarico, in quanto dotato di meccanismo di risciacquo con doppio scarico da 1,8 a 3 litri. Ultracompatto: 43 cm profondità. A corredo: valvola clapet, fissaggi a terra.



Applicazioni: WC - lavabo
Capacità di scarico: 3 metri in verticale (tubo Ø 32 mm.)
 30 metri in orizzontale (tubo Ø 32/40 mm.)

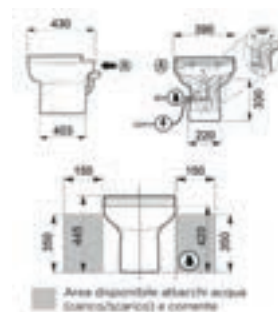

codice	sigla	Nr. entrate	Livello sonoro	UM	min. ord. conf.	cat.	prezzo (€)
● 3350001	CPT43LS	1	51 dB(A)	NR	1	13	

SANICOMPACT LUXE SILENCE

WC in ceramica dal design classico con trituratore incorporato, sedile antibatterico. Non necessita di cassetta di scarico in quanto è dotato di meccanismo di risciacquo con doppio scarico da 1,8 a 3 litri. A corredo: valvola clapet, fissaggi a terra.



Applicazioni: WC - lavabo
Capacità di scarico: 3 metri in verticale (tubo Ø 32 mm.)
 30 metri orizzontale (tubo Ø 32/40 mm.)

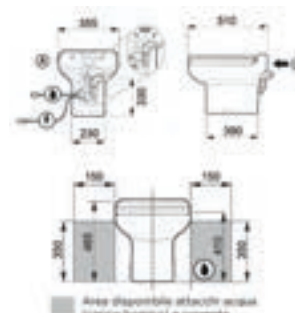

codice	sigla	Nr. entrate	Livello sonoro	UM	min. ord. conf.	cat.	prezzo (€)
● 3550003	CPTLS	1	51 dB(A)	NR	1	13	

LIQUIDO ANTICALCARE PER TRITURATORI

Anticalcare specifico per trituratori, sgrassante e disinfettante. Non è un disotturante.



codice	sigla	descrizione	UM	min. ord. conf.	cat.	prezzo (€)
● 3350503	ANTICALC	Tanica 5 litri	NR	1	10	

SANISHOWER PLUS+

Pompa e sifone per piatto doccia classico. Possibilità di collegare anche un lavabo o un bidet. A corredo: valvola clapet, filtro a carboni attivi, per neutralizzare gli odori.

Applicazioni: lavabo - cabina doccia - bidet - addolcitore acqua
Capacità di scarico: 5 metri in verticale (tubo Ø 32 mm.)
 50 metri in orizzontale (tubo Ø 32 mm.)

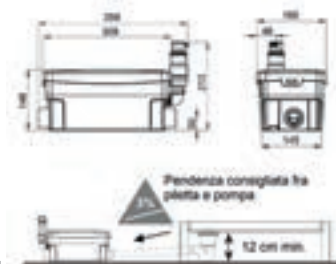

codice	sigla	Nr. entrate	Livello sonoro	UM	min. ord. conf.	cat.	prezzo (€)
● 3350040	SH+	2	40 dB(A)	NR	1	13	

SANIVITE PLUS+

Pompa domestica per acque chiare, specifica per cucine e lavanderie. Temperatura max delle acque reflue: 60°C ad intermittenza (max 5 min.) A corredo: valvola clapet, filtro a carboni attivi, per neutralizzare gli odori.

Applicazioni: lavatrice - lavabo - lavastoviglie - bidet - lavello - doccia - vasca da bagno - addolcitore acqua
Capacità di scarico: 5 metri in verticale (tubo Ø 32 mm.)
 50 metri in orizzontale (tubo Ø 32 mm.)

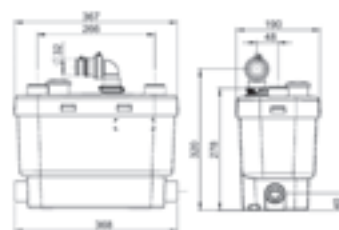

codice	sigla	Nr. entrate	Livello sonoro	UM	min. ord. conf.	cat.	prezzo (€)
● 3350110	SVES+	4	46 dB(A)	NR	1	13	

SANISPEED PLUS+

Pompa per acque chiare ideale per ambienti commerciali come piccoli negozi, uffici, bar, lavanderie e studi dentistici. Temperatura max delle acque reflue: 75°C ad intermittenza (max 5 min.) A corredo: valvola clapet, filtro a carboni attivi per neutralizzare gli odori.

Applicazioni: lavabo - bidet - doccia - vasca da bagno - lavello - lavatrice - lavastoviglie
Capacità di scarico: 7 metri in verticale (tubo Ø 32 mm.)
 70 metri in orizzontale (tubo Ø 32 mm.)

NOVITÀ!

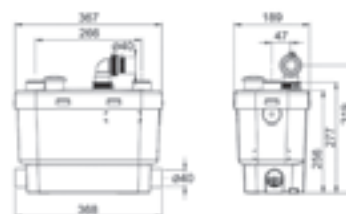

codice	sigla	Nr. entrate	Livello sonoro	UM	min. ord. conf.	cat.	prezzo (€)
● 3350640	SDS+	4	42 dB(A)	NR	1	13	

SANICUBIC 1

Stazione di sollevamento per acque chiare e scure con una testata trituratrice, progettata per uso singolo (villetta, piccolo locale commerciale). Potenza motore 1.500 W. Temperatura max delle acque reflue: 70°C ad intermittenza (max 5 min.) A corredo: valvola clapet integrata, allarme remoto via cavo.

Applicazioni: lavabo - bidet - wc - vasca da bagno - doccia - lavatrice - lavello - lavastoviglie - degrassatore
Capacità di scarico: 11 metri in verticale (tubo Ø 50 mm.)
 110 metri in orizzontale (tubo Ø 50 mm.)

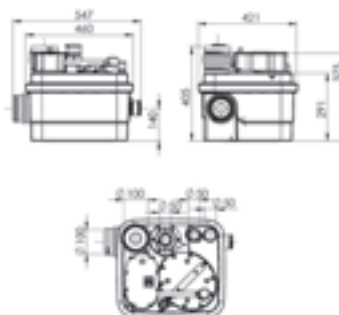

codice	sigla	Indice di protezione	Serbaio	UM	min. ord. conf.	cat.	prezzo (€)
● 3350070	SQ1	IP 67	32 lt	NR	1	17	

CATALOGO
LISTINO N° 6

PRODOTTI TECNICI

MINUTERIA IDRAULICA E ACCESSORI	190
PRODOTTI TECNICI E CHIMICI	196
CONTATORI ACQUA	203
RUBINETTERIA DA ESTERNO	205
RUBINETTI GALLEGGIANTI	207

MINUTERIA IDRAULICA E ACCESSORI

TUBI CROMATI IN RAME

ROTOLO TUBO RAME



codice	sigla	∅	lungh. (cm)	UM	min. ord.	conf.	cat.	prezzo (€)
● 2750101	06600500CR	10	500	NR	1	10	09	
● 2750102	06602500CR	12	500	NR	1	10	09	

TUBETTO PROLUNGA



codice	∅	lungh. (cm)	UM	min. ord. conf.	cat.	prezzo (€)
● 2750501	10	30	NR	10	09	

TUBETTO PER MISCELATORE



codice	∅	lungh. (cm)	UM	min. ord. conf.	cat.	prezzo (€)
● 2750502	10	30	NR	1	09	

TUBETTO LISCIO



codice	∅	lungh. (cm)	UM	min. ord. conf.	cat.	prezzo (€)
● 2750510	10	100	NR	1	09	

TUBETTO CON GHIERA



codice	sigla	∅	lungh. (cm)	UM	min. ord. conf.	cat.	prezzo (€)
● 2750541	02700030CR	3/8"x10	30	NR	25	09	
● 2750540	02700100CR	3/8"x10	100	NR	10	09	
● 2750531	02500030CR	1/2"x10	30	NR	25	09	
● 2750532	02500050CR	1/2"x10	50	NR	25	09	
● 2750533	02500100CR	1/2"x10	100	NR	10	09	

BICONO MASCHIO



codice	sigla	Ø	filetto (mm)	UM	min. ord. conf.	cat.	prezzo (€)
● 2750240	0321B330CR	3/8" x10	13	NR	10	06	
● 2750241	0320B330CR	3/8" x10	20	NR	10	06	
● 2750242	0320B342CR	3/8" x12	20	NR	10	06	
● 2750244	0321B430CR	1/2" x10	13	NR	10	06	
● 2750245	0320B430CR	1/2" x10	20	NR	10	06	
● 2750246	0320B442CR	1/2" x12	20	NR	10	06	
● 2750247	0320B444CR	1/2" x14	20	NR	10	06	

BICONO FEMMINA



codice	sigla	attacco Ø	calotta Ø	UM	min. ord. conf.	cat.	prezzo (€)
● 2750311	0041B330CR	3/8"	3/8" x10	NR	10	06	
● 2750313	0041B430CR	1/2"	3/8" x10	NR	10	06	
● 2750314	0041B440CR	1/2"	1/2" x10	NR	10	06	
● 2750315	0041B442CR	1/2"	1/2" x12	NR	10	06	
● 2750316	0041B444CR	1/2"	1/2" x14	NR	10	06	

BICONO DOPPIO



codice	sigla	calotta Ø	UM	min. ord. conf.	cat.	prezzo (€)
● 2750301	0040B310CR	3/8" x10	NR	10	06	

BICONO DOPPIO A GOMITO



codice	sigla	calotta Ø	UM	min. ord. conf.	cat.	prezzo (€)
● 2750321	0042B310CR	3/8" x10	NR	10	06	

BICONO MASCHIO PROLUNGATO CON ROSONE



codice	sigla	attacco Ø	calotta Ø	UM	min. ord. conf.	cat.	prezzo (€)
● 2750251	0330C330CR	3/8"	3/8" x10	NR	2	06	
● 2750252	0330C430CR	1/2"	3/8" x10	NR	2	06	

NIPPLE RIDOTTO PROLUNGATO CON ROSONE



codice	sigla	Ø	UM	min. ord. conf.	cat.	prezzo (€)
● 2750263	0330R430CR	1/2" x3/8"	NR	2	06	

PROLUNGA PER RETROGRUPPO CALOTTA GIREVOLE

Lunghezza 40 mm



codice	sigla	attacco Ø	foro Ø	UM	min. ord. conf.	cat.	prezzo (€)
● 2751122	00630530CR	3/4" M x 3/4" F	3/8"	NR	1	06	
● 2751123	0063F540CR	3/4" M x 3/4" F	1/2"	NR	1	06	
● 2751121	00620500CR	3/4" M x 3/4" F	-	NR	1	06	

NIPPLE RIDOTTO PROLUNGATO SENZA ROSONE



codice	sigla	Ø	UM	min. ord. conf.	cat.	prezzo (€)
● 2750264	03300430CR	1/2" x3/8"	NR	2	06	
● 2750266	03300442CR	1/2" x1/2"	NR	2	06	

PROLUNGA CON E SENZA CALOTTA

Lunghezza 40 mm



codice	sigla	attacco Ø	calotta Ø	UM	min. ord. conf.	cat.	prezzo (€)
● 2735041	0050B340CR	3/8"	3/8" x10	NR	10	06	
● 2735031	00500340CR	3/8"	-	NR	10	06	

MINUTERIA IDRAULICA E ACCESSORI

ROSONI

ROSONE PER CURVE 45°



codice	sigla	rosone (mm)	altezza (mm)	UM	min. ord. conf.	cat.	prezzo (€)
● 2661006	-115.321.0.	77	18	NR	10	20	

ROSONE PER CANOTTO



codice	Ø tubo	rosone (mm)	altezza (mm)	UM	min. ord. conf.	cat.	prezzo (€)
● 2750601	26	76	32	NR	50	20	
● 2750602	30	76	32	NR	50	20	
● 2750603	32	76	32	NR	50	20	

ROSONE GIGANTE



codice	Ø tubo	rosone (mm)	altezza (mm)	UM	min. ord. conf.	cat.	prezzo (€)
● 2750623	32	105	42	NR	10	20	

ROSONE



codice	Ø	rosone (mm)	UM	min. ord. conf.	cat.	prezzo (€)
● 2750620	1/2"	59	NR	100	20	
● 2750640	3/4"	72	NR	50	20	

ROSONE A SCATOLA



codice	sigla	Ø	rosone (mm)	altezza (mm)	UM	min. ord. conf.	cat.	prezzo (€)
● 2750624	06550410CR	1/2"	60	10	NR	50	20	
● 2750625	06550420CR	1/2"	60	20	NR	15	20	

CAPPUCCIO UNIVERSALE PER RUBINETTO INCASSO



codice	sigla	Ø	rosone (mm)	altezza (mm)	UM	min. ord. conf.	cat.	prezzo (€)
● 2750903	05820000CR	1/2"	60	55	NR	1	20	

MINUTERIA IDRAULICA E ACCESSORI

TAPPI COPRIFORO

COPRIFORO mm.54,5 D.1/2" CROMATO



codice	sigla	Ø	rosone (mm)	UM	min. ord.	conf.	cat.	prezzo (€)
● 2750901	06700400CR	M 1/2"	54,5	NR	1	50	20	

COPRIFORO CROMATO



codice	sigla	Ø	UM	min. ord.	conf.	cat.	prezzo (€)
● 2750902	06750000CR	54	NR	1	50	20	

COPRIFORO BIANCO

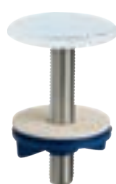

codice	Ø	UM	min. ord. conf.	cat.	prezzo (€)
● 2750904	50	NR	20	20	

COPRIFORO BIANCO RAL 9010



codice	sigla	Ø	UM	min. ord.	conf.	cat.	prezzo (€)
● 2750908	06750000VR	54	NR	1	50	20	

TAPPO PROVA IMPIANTI 1/2" CON GUARNIZIONE



codice	colore	UM	min. ord.	conf.	cat.	prezzo (€)
● 2651046	ROSSO	NR	10	200	14	
● 2651047	BLU	NR	10	200	14	

BORCHIA CROMATA PER TROPPO PIENO



codice	Ø	UM	min. ord. conf.	cat.	prezzo (€)
● 2750905	18	NR	10	24	
● 2750906	24	NR	10	24	
● 2750907	28	NR	10	24	

PRODOTTI TECNICI

MORSETTI

MORSETTO PER CONDIZIONAMENTO



codice	Ø	Ø cannette	UM	min. ord. conf.	cat.	prezzo (€)
● 2006607	34	14	NR	50	14	

MORSETTO PER TUBO SCARICO REDI



codice	Ø	Ø canotto	UM	min. ord. conf.	cat.	prezzo (€)
● 2006608	32	26	NR	50	14	

MINUTERIA IDRAULICA E ACCESSORI

MORSETTI

MORSETTO PER CURVA TECNICA



codice	∅	∅ canotto (mm)	UM	min. ord. conf.	cat.	prezzo (€)
● 2006602	40	26-32	NR	50	23	

MORSETTO PER CURVA TECNICA

Per Geberit e Wavin



codice	∅	∅ canotto (mm)	UM	min. ord. conf.	cat.	prezzo (€)
● 2006605	47	26-32	NR	50	23	

MORSETTO PER CURVA TECNICA

Per Geberit



codice	∅	∅ canotto (mm)	UM	min. ord. conf.	cat.	prezzo (€)
● 2006606	46	40	NR	50	23	

MORSETTO PER CURVA TECNICA



codice	∅	∅ canotto (mm)	UM	min. ord. conf.	cat.	prezzo (€)
● 2006603	50	26-32	NR	50	23	
● 2006604	50	40	NR	50	23	

MORSETTO BIANCO PER WC



codice	∅	∅ canotto (mm)	foto	UM	min. ord. conf.	cat.	prezzo (€)
● 2006601	50	26-32	1	NR	50	23	
● 3302114	50	40	2	CF	1	23	

MORSETTO BIANCO PER WC



codice	∅	∅ canotto (mm)	foto	UM	min. ord. conf.	cat.	prezzo (€)
● 2006621	60	30	1	NR	50	23	
● 3302115	60	40	2	CF	1	23	

MANICOTTI WC

MANICOTTO SCARICO WC DIRITTO BIANCO



codice	∅	UM	min. ord.	conf.	cat.	prezzo (€)
● 2651034	110	NR	1	60	24	

MANICOTTO SCARICO WC ECCENTRICO BIANCO



codice	∅	UM	min. ord.	conf.	cat.	prezzo (€)
● 2651035	110	NR	1	60	24	

MANICOTTO WC DRITTO IN GOMMA NERA



codice	∅	UM	min. ord. conf.	cat.	prezzo (€)
● 2005015	100-110	NR	1	23	

MANICOTTO WC ECCENTRICO IN GOMMA NERA



codice	∅	UM	min. ord. conf.	cat.	prezzo (€)
● 2005016	110	NR	1	23	

MINUTERIA IDRAULICA E ACCESSORI

CURVE TECNICHE WC

CURVA TECNICA WC C/GUARNIZIONE EPDM



codice	∅	UM	min. ord.	conf.	cat.	prezzo (€)
● 2651052	90	NR	1	30	24	
● 2651051	100	NR	1	24	24	
● 2651050	110	NR	1	24	24	

TUBO PROLUNGA WC



codice	∅	lunghezza (cm)	UM	min. ord.	conf.	cat.	prezzo (€)
● 2651059	90	35	NR	1	16	24	
● 2651062	100	25	NR	1	16	24	
● 2651061	110	25	NR	1	16	24	
● 2651060	110	35	NR	1	16	24	

CURVA WC PER RISTRUTTURAZIONE



codice	∅	UM	min. ord.	conf.	cat.	prezzo (€)
● 2651053	90-100-110	NR	1	12	24	

CURVA TECNICA DA TAGLIARE



codice	∅	UM	min. ord.	conf.	cat.	prezzo (€)
● 2651054	100	NR	1	18	24	

TUBO ESTENSIBILE PER WC



codice	∅	lunghezza (cm)	UM	min. ord.	conf.	cat.	prezzo (€)
● 2005013	90-100-110	23-57	NR	1	10	24	

ROSONE DI RIFINITURA



codice	∅	UM	min. ord.	conf.	cat.	prezzo (€)
● 2651070	90	NR	1	10	24	
● 2651072	110	NR	1	10	24	

KIT FISSAGGIO PER CURVA TECNICA



codice	UM	min. ord.	conf.	cat.	prezzo (€)
● 2651058	NR	1	10	24	

GUARNIZIONE CON ALETTA PER CURVA TECNICA



codice	∅	UM	min. ord.	conf.	cat.	prezzo (€)
● 2651057	90-100-110	NR	1	10	24	

PRODOTTI TECNICI E CHIMICI

TRATTAMENTO E MANUTENZIONE IMPIANTI

F1 PROTECTOR ml.500

Protettivo. Soluzione neutra che protegge dalla corrosione interna e dai depositi di calcare tutti i tipi di impianti termici.

Compatibile con tutti i tipi di metalli (compreso alluminio), plastiche e materiali comunemente utilizzati.

Dosaggio: 500 ml ogni 100 lt d'acqua. Prima di aggiungere F1 Protector, pulire l'impianto con F3 Cleaner.



codice	sigla	UM	min. ord. conf.	cat.	prezzo (€)
● 2009003	53663	NR	10	05	

F3 CLEANER ml.500

Rigeneratore. Soluzione neutra per rimuovere fanghi, alghe e depositi da impianti vecchi, o residui di fabbricazione ed installazione da impianti nuovi.

Compatibile con tutti i tipi di metalli (compreso alluminio), plastiche e materiali comunemente utilizzati.

Dosaggio: 500 ml ogni 100 lt d'acqua. Dopo aver pulito l'impianto si raccomanda di aggiungere F1 Protector.



codice	sigla	UM	min. ord. conf.	cat.	prezzo (€)
● 2009004	53637	NR	10	05	

F4 LEAK SEALER ml.500

Sigillaperdite. Soluzione neutra per sigillare micro-fessure responsabili di piccole perdite ed inaccessibili, in tutti i tipi di impianti termici.

Compatibile con tutti i tipi di metalli (compreso alluminio), e materiali comunemente utilizzati.

Dosaggio: 500 ml ogni 100 lt d'acqua, efficace nell'arco di 1-24 ore, in acqua tiepida/calda circolante. Non viene garantita la sigillatura di qualsiasi tipo di perdita. Una volta sigillata la perdita si raccomanda di aggiungere F1 Protector.



codice	sigla	UM	min. ord. conf.	cat.	prezzo (€)
● 2009005	52818	NR	1	10	05

F8 POWERFLUSHING CLEANER ml.500

Detergente. Soluzione neutra ad alte prestazioni per impianti termici molto contaminati, rimuove residui di lavorazione, fanghi ed incrostazioni da nuovi e vecchi impianti di qualsiasi età con problemi ostinati, ripristinando l'efficienza di riscaldamento, riducendo il rumore della caldaia.

Dosaggio: 500 ml ogni 130 lt d'acqua. Ø 16 radiatori.

Dopo aver pulito l'impianto si raccomanda di aggiungere F1 Protector.



codice	sigla	UM	min. ord. conf.	cat.	prezzo (€)
● 2009017	62487	NR	1	10	05

F7 BIOCIDE ml. 200

Antialghe. Additivo concentrato per impianti riscaldamento a pavimento e refrigerazione, per evitare la proliferazione batterica e la formazione di alghe.

Dosaggio: 200 ml ogni 150 lt d'acqua, da utilizzare in abbinamento all'F1 Protector



codice	sigla	UM	min. ord. conf.	cat.	prezzo (€)
● 2009000	62393	NR	1	10	05

SOLAR S1 lt.10

Fluido termovettore. Protezione anticorrosiva e antigelo (fino a -28°C) per impianti solari che raggiungono temperature molto elevate (ristagno superiore a 360°C).

PRONTO ALL'USO (quindi non diluire)



codice	sigla	UM	min. ord. conf.	cat.	prezzo (€)
● 2009008	57675	NR	1	05	

FILTER FLUID + PROTECTOR ml.500

Abbinato ad un defangatore magnetico, protegge l'impianto dalla corrosione e dalle incrostazioni. Miscela di disperdenti che porta in sospensione le impurità convogliandole nel filtro.

E' possibile quindi lasciarlo all'interno dell'impianto senza effettuare il risciacquo.

Dosaggio: 500 ml ogni 100 lt d'acqua



codice	sigla	UM	min. ord. conf.	cat.	prezzo (€)
● 2009009	62235	NR	1	10	05

DISINCROSTANTE ACIDO INIBITO lt.5

Liquido a viraggio di colorazione inibito specifico per la rimozione di incrostazioni calcaree e ossidi da scambiatori di calore e superfici metalliche. Compatibile con ACCIAIO, RAME e GHISA (non adatto su alluminio, inox e acciaio zincato). Diluizione consigliata: 10%-20%



codice	UM	min. ord. conf.	cat.	prezzo (€)
● 2006020	NR	1	4	06

SILICONE ANTIMUFFA



codice	descrizione	contenuto (ml)	UM	min. ord.	conf.	cat.	prezzo (€)
● 2005030	Acetico Trasparente	280	NR	24	24	21	
● 2005031	Acetico Bianco	280	NR	24	24	21	
● 2005040	Neutro Trasparente	310	NR	24	24	21	
● 2005041	Neutro Bianco	310	NR	1	24	21	
● 2005050	Alta Temperatura rosso	280	NR	1	24	21	
● 2005051	Alta Temperatura nero	280	NR	1	24	21	

SIGILLANTE E ADESIVO IBRIDO

Incolla e sigilla piastrelle, pietra, granito, vetro, metacrilato, PVC, cartongesso, intonaco, acciaio, lamiera, alluminio, rame, polistirolo. Anche su superfici umide. Inodore e verniciabile.



codice	colore	contenuto (gr)	UM	min. ord. conf.	cat.	prezzo (€)
● 2005084	cristallino	290	NR	1	21	

PASTA SIGILLANTE PER GIUNTI FILETTATI

In condotte di acqua, gas naturale e gas di città.



codice	contenuto (gr)	UM	min. ord. conf.	cat.	prezzo (€)
● 2006372	450	NR	12	02	

ERMETIC PASTA VERDE

Mastice per raccordi filettati, impianti civili ed industriali.

Limite di temperatura: -20°C + 70°C (gas)
-20°C + 90°C (acqua)



codice	contenuto (gr)	UM	min. ord. conf.	cat.	prezzo (€)
● 2006373	460	NR	30	02	

EXTRA GAS PASTA MARRONE

Mastice di alta qualità per raccordi filettati, ideale per gas metano, NON ADATTO PER GPL.

Limite di temperatura: -30°C + 70°C (gas)
-30°C + 90°C (acqua)



codice	contenuto (gr)	UM	min. ord. conf.	cat.	prezzo (€)
● 2006374	460	NR	30	02	

FILO SIGILLANTE LOCTITE 55

Nastro in multifibra di nylon, in sostituzione di paste, canapa e nastri di tenuta.

Rispetta le seguenti normative:

- ACQUA POTABILE: Cert. Italiana C.S.A.,

standard KTW, approvato WRC.

- GAS E ACQUA: Marchio IMO-UNICIG, UNI EN 751-2, approvato DVGW, DIN 32160



codice	contenuto (mt)	UM	min. ord. conf.	cat.	prezzo (€)
● 2006361	160	NR	15	04	

KIT LOCTITE 55 (5pz.+OMAGGIO)

Kit formato da 5 pezzi di Loctite 55 (2006361) e oggettistica in omaggio (variabile)



codice	UM	min. ord.	conf.	cat.	prezzo (€)
● 2006363	CF	1	10	04	

PRODOTTI TECNICI E CHIMICI

SILICONI E SIGILLANTI

TANGIT PVC-U TUBETTO

Adesivo speciale a presa rapida, a base di solvente, per PVC-U rigido e ABS, non adatto per PE, PP e PTFE.



codice	contenuto (gr)	UM	min. ord. conf.	cat.	prezzo (€)
● 2006380	125	NR	12	05	

TANGIT PVC-U BARATTOLO + PENNELLO

Adesivo speciale a presa rapida, a base di solvente, per PVC-U rigido e ABS, non adatto per PE, PP e PTFE.



codice	contenuto (gr)	UM	min. ord. conf.	cat.	prezzo (€)
● 2006381	250	NR	12	05	

CANAPA PETTINATA

Extra fine



codice	contenuto (gr)	UM	min. ord. conf.	cat.	prezzo (€)
● 2006002	250	NR	1	80	06

STRISCE BUTILICHE ELASTOPLASTICHE AUTOADESIVE

Indicato per piani cottura e per giunzioni tra vetro, legno, metallo e vetroresina. Foglio da n.4 strisce preformate 490x15x8 mm. pronte all'uso.



codice	UM	min. ord. conf.	cat.	prezzo (€)
● 2005090	NR	30	08	

SCHIUMA POLIURETANICA LAND

Schiuma poliuretana autoespandente per la sigillatura impermeabile di pozzetti, tubi e canali sia di materiale cementizio che di materiale plastico. Non idonea su PE, silicone e PTFE. Pronto all'uso, di colore blu.



codice	contenuto (ml)	UM	min. ord. conf.	cat.	prezzo (€)
● 2006025	750	NR	1	12	06

ADESIVO PER PVC IN TUBETTO

Adesivo saldante trasparente, a base di PVC disciolto in solventi. Per tubi e raccordi in PVC rigido, utilizzabile anche per incollare ABS, PVA e polistirolo rigido.



codice	contenuto (gr)	UM	min. ord. conf.	cat.	prezzo (€)
● 2006385	125	NR	1	30	21

COLLA K 414

Adesivo per isolamento in gomma espansa, resistente agli agenti atmosferici e all'invecchiamento.



codice	contenuto (gr)	UM	min. ord. conf.	cat.	prezzo (€)
● 2006350	0,5	NR	1	20	19

CANAPA IN BALLETTTE

Extra fine



codice	contenuto (kg)	UM	min. ord. conf.	cat.	prezzo (€)
● 2006004	25	KG	25	06	

DRIP STOP MASTICE EPOSSIDICO BICOMPONENTE

Bicomponente per arrestare le perdite di tubazioni senza svuotare l'impianto. Verniciabile, ideale per riparazioni su metalli, vetro, plastica, legno. Polimerizza a temperatura ambiente ed anche immerso nell'acqua.



codice	contenuto (gr)	UM	min. ord. conf.	cat.	prezzo (€)
● 2006029	65	NR	1	24	02

NASTRO P.T.F.E. PROFESSIONALE

Alta qualità (100% PTFE), ideale per grandi diametri (>2")



codice	spess. (mm)	altezza (mm)	lung. (mt)	colore	UM	min. ord.	conf.	cat.	prezzo (€)
● 2006307	0,20	19	15	giallo	NR	25	250	22	
● 2006308	0,20	25	15	rosso	NR	25	25	22	

NASTRO P.T.F.E. ALTA DENSITA'

Particolarmente indicato per temperature e pressioni elevate (per esempio impianti di vapore, pannelli solari, ecc.)



codice	spess. (mm)	altezza (mm)	lung. (mt)	colore	UM	min. ord.	conf.	cat.	prezzo (€)
● 2006323	0,10	12	12	bianco	NR	10	250	22	
● 2006322	0,10	12	12	rosa	NR	10	250	22	

NASTRO P.T.F.E. GAS



codice	spess. (mm)	altezza (mm)	lung. (mt)	UM	min. ord. conf.	cat.	prezzo (€)
● 2006304	0,10	12	12	NR	250	22	
● 2006305	0,10	19	12	NR	250	22	

NASTRO P.T.F.E. CERTIFICATO DVGW

Conforme alla norma UNI-EN 751-3, Certificato DIN-DVGW e BAM. Indispensabile per sigillature a norma di raccordi filettati in condotte di gas, acqua, ossigeno, ecc.



codice	spess. (mm)	altezza (mm)	lung. (mt)	UM	min. ord. conf.	cat.	prezzo (€)
● 2006330	0,10	12	12	NR	250	22	

NASTRO P.T.F.E.

Nastro in resina PTFE per tenuta di raccordi filettati di qualsiasi tipo (metallo, plastica ecc.). Atossico, inodore, insolubile ed infiammabile, adatto per impianti alimentari e chimici.



codice	spess. (mm)	altezza (mm)	lung. (mt)	UM	min. ord. conf.	cat.	prezzo (€)
● 2006300	0,076	12	10	NR	250	22	
● 2006301	0,076	12	12	NR	250	22	

NASTRO ADESIVO ANTICONDENSA

In elastomero



codice	spess. (mm)	altezza (mm)	lung. (mt)	UM	min. ord. conf.	cat.	prezzo (€)
● 2006341	3	50	10	NR	24	19	
● 2006340	3	50	15	NR	12	19	

PRODOTTI TECNICI E CHIMICI

NASTRI

NASTRO ADESIVO ALLUMINIO LISCIO

In alluminio puro



codice	spess. (micron)	altezza (mm)	lungh. (mt)	UM	min. ord. conf.	cat.	prezzo (€)
● 2006410	25	50	50	NR	24	19	

NASTRO ADESIVO ALLUMINIO LISCIO

In alluminio anodizzato



codice	spess. (micron)	altezza (mm)	lungh. (mt)	UM	min. ord. conf.	cat.	prezzo (€)
● 2006413	40	50	50	NR	24	09	

NASTRO ADESIVO ALLUMINIO RETINATO

Retinatura in vetro tessile



codice	spess. (micron)	altezza (mm)	lungh. (mt)	UM	min. ord. conf.	cat.	prezzo (€)
● 2006415	43	50	50	NR	24	19	

NASTRO ADESIVO DIELETTRICO PVC



codice	altezza (mm)	lungh. (mt)	colore	UM	min. ord. conf.	cat.	prezzo (€)
● 2006313	38	25	nero	NR	24	19	
● 2006311	50	25	nero	NR	18	19	
● 2006312	50	25	grigio	NR	18	19	

BENDA VINILICA

In PVC, non adesiva.



codice	altezza (cm)	lungh. (mt)	colore	UM	min. ord. conf.	cat.	prezzo (€)
● 2006346	10	25	bianca	NR	70	19	

NASTRO SEGNALETICO ACQUA/GAS

Nastro di polietilene (80µm) per la segnalazione di tubi acqua e gas interrati. Striscia di avvertimento da posare a 30/50 cm sopra il tubo.



codice	tipo	altezza (mm)	lungh. (mt)	UM	min. ord. conf.	cat.	prezzo (€)
● 2006030	ACQUA	12,5	200	NR	1	10	02
● 2006031	GAS	12,5	200	NR	1	10	02

CLIMAFOAM SPRAY

Detergente schiumogeno per condizionatori per la pulizia dei pacchi alettati e dei filtri delle unità interne degli impianti di aria condizionata. Disgrega lo sporco ed emulsionandolo permette di eliminarlo facilmente.



CONDIBAT SPRAY

Sanificante e igienizzante per condizionatori, fan coil e piccoli ambienti in soluzione alcolica >70% in combinazione con sostanze fenoliche. Testato secondo il metodo UNI EN 1040:2005

Proprietà chimico fisiche

Forma: Aerosol
 Colore: Incolore
 Odore: Fiori di campo
 pH: 11,25 ± 0,25
 Solubilità/Miscibilità acqua: Poco solubile
 VOC (%): 50,40



codice	contenuto (ml)	UM	min. ord. conf.	cat.	prezzo (€)
● 2006010	500	NR	12	02	

codice	contenuto (ml)	UM	min. ord. conf.	cat.	prezzo (€)
● 2006011	500	NR	12	02	

TANGIT KS DETERGENTE

Detergente specifico per giunzioni in plastica da termosaldare. Adatto per PE, PP e PVDF.



DETERPLAST SPRAY PER GIUNTI ELETTROSALDABILI

Detergente spray a base di solventi, specifico per la pulizia di giunti da elettrosaldare. Adatto per PE e PP.



codice	contenuto (lt)	UM	min. ord. conf.	cat.	prezzo (€)
● 2006382	1	NR	8	05	

codice	contenuto (lt)	UM	min. ord. conf.	cat.	prezzo (€)
● 2006034	400	NR	12	02	

SCIVOLINA SPRAY BOMBOLA

Lubrificante protettivo spray, a base di olio di silicone, confezionato con propellente esente da CFC. Ideale per l'innesto di tubazioni in pp e PVC con anello; oltre a facilitare lo scorrimento mantiene morbida la guarnizione nel tempo.



SCIVOLINA TUBETTO

Gel lubrificante, inodore, a base di olii silconici. Facilita l'innesto di tubi con o-ring, protegge la guarnizione. Non contiene alcun tipo di sapone.



codice	contenuto (ml)	UM	min. ord. conf.	cat.	prezzo (€)
● 2006384	400	NR	1	12	21

codice	contenuto (ml)	UM	min. ord. conf.	cat.	prezzo (€)
● 2006383	250	NR	1	50	21

CS CLEANER DISINCROSTANTE CASSETTE

Liquido a viraggio di colorazione inibito specifico per la rimozione rapida di incrostazioni calcaree ed ossidi nelle cassette di risciacquo wc. Evita il rigagnolo giallo nei wc e ripristina un buon funzionamento del galleggiante. Indicatore di viraggio: ROSSO (attivo), GIALLO/ARANCIO (esausto).



SOLVACAL DISINCROSTANTE IN POLVERE

Prodotto in polvere per la rimozione del calcare da sanitari, docce, rubinetterie, superfici in acciaio inox. Diluito in acqua può essere utilizzato per la pulizia di scambiatori e tubazioni.



codice	contenuto (lt)	UM	min. ord. conf.	cat.	prezzo (€)
● 2006012	1	NR	12	06	

codice	contenuto (gr)	UM	min. ord. conf.	cat.	prezzo (€)
● 2006013	500	NR	1	36	06

PRODOTTI TECNICI E CHIMICI

PRODOTTI CHIMICI

SGORGOSI' DISOTTURANTE

Disotturante liquido ad alta concentrazione per scarichi, **solo ad uso professionale**, altamente corrosivo.



	codice	contenuto (lt)	UM	min. ord. conf.	cat.	prezzo (€)
●	2006390	1	NR	6	06	

SGORGOSI' GEL DISOTTURANTE

Disotturante gel per scarichi occlusi da materiale organico. Gradevolmente profumato (fresco balsamico).



	codice	contenuto (lt)	UM	min. ord. conf.	cat.	prezzo (€)
●	2006391	1	NR	6	06	

EFFE 91 RILEVATORE FUGHE GAS

Rilevatore di piccole e grandi fughe di gas metano e GPL. Non è infiammabile, non macchia, non favorisce ossidazioni.



	codice	contenuto (lt)	UM	min. ord. conf.	cat.	prezzo (€)
●	2006032	400	NR	12	02	

WD-40 LUBRIFICANTE MULTIFUNZIONE

Lubrificante, sloccante, elimina cigolii, elimina l'umidità, previene la ruggine e protegge tutte le superfici metalliche non porose. Doppia erogazione (vaporizzazione ampia e applicazione dei precisione).



	codice	contenuto (lt)	UM	min. ord. conf.	cat.	prezzo (€)
●	2006024	500	NR	6	24	05

PRODOTTI TECNICI

TRACK VERNICE TRACCIANTE SPRAY NERO

Utilizzabile su qualsiasi superficie (muratura, pavimentazione, asfalto, legno, ecc.). Ottima resistenza agli agenti atmosferici.



	codice	contenuto (lt)	UM	min. ord. conf.	cat.	prezzo (€)
●	2006033	400	NR	12	02	

TRACK VERNICE TRACCIANTE SPRAY ROSSO

Utilizzabile su qualsiasi superficie (muratura, pavimentazione, asfalto, legno, ecc.). Ottima resistenza agli agenti atmosferici.

NOVITÀ!



	codice	contenuto (lt)	UM	min. ord. conf.	cat.	prezzo (€)
●	2006035	400	NR	12	02	

CONTATORE ACQUA FREDDA



Installazione sia orizzontale che verticale. Quadrante asciutto a trasmissione magnetica Super Dry 8 rulli.
Pressione Nominale 16 bar, temperatura max 50°C.
A norma Europea EN 14154, direttiva 2004/22/CE (MID), certificazione di utilizzo con acque potabili DM 6/4/2004 n.174.
Non predisposti per emettitore impulsi
Confezione completa di raccordi.

Su richiesta, è possibile avere:
- versione con emettitore impulsi P = 10 lt.
- versione con predisposizione radio 868 MHz (EN 13757) OMS.



codice	Ø	Portata Q3 (m³/ora)	UM	min. ord.	conf.	cat.	prezzo (€)
● 1207101	1/2"	2,5	NR	1	10	05	
● 1207102	3/4"	4,0	NR	1	10	05	

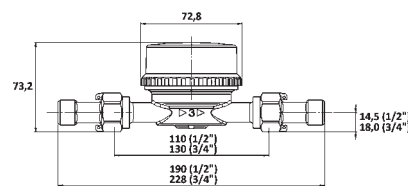

CONTATORE ACQUA FREDDA CON COPERCHIO



Installazione sia orizzontale che verticale. Quadrante a rulli protetti, con l'area di lettura non a contatto con l'acqua.
Pressione Nominale 16 bar, temperatura massima 50°C.
A norma Europea EN 14154, direttiva 2004/22/CE (MID), certificazione di utilizzo con acque potabili DM 6/4/2004 n.174.
Non predisposti per emettitore impulsi
Confezione completa di raccordi.

Su richiesta, è possibile avere:
- versione con emettitore impulsi P = 1-10 lt.



codice	Ø	Portata Q3 (m³/ora)	UM	min. ord.	conf.	cat.	prezzo (€)
● 1207121	1"	6,3	NR	1	10	05	

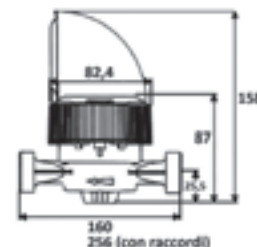

CONTATORE ACQUA CALDA



Installazione sia orizzontale che verticale. Quadrante asciutto a trasmissione magnetica Super Dry 8 rulli.
Pressione Nominale 16 bar, temperatura max 90°C.
A norma Europea EN 14154, direttiva 2004/22/CE (MID), certificazione di utilizzo con acque potabili DM 6/4/2004 n.174.
Non predisposti per emettitore impulsi
Confezione completa di raccordi.

Su richiesta, è possibile avere:
- versione con emettitore impulsi P = 10 lt.
- versione con predisposizione radio 868 MHz (EN 13757) OMS.



codice	Ø	Portata Q3 (m³/ora)	UM	min. ord.	conf.	cat.	prezzo (€)
● 1207111	1/2"	2,5	NR	1	10	05	
● 1207112	3/4"	4,0	NR	1	10	05	

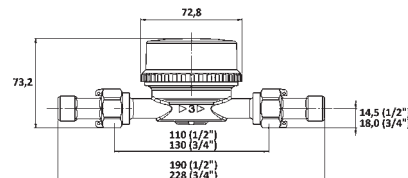

RACCORDO PER CONTATORE



codice	Ø	UM	min. ord.	conf.	cat.	prezzo (€)
● 1560001	3/4" x 1/2"	NR	10	06		
● 1560002	1" x 3/4"	NR	2	06		

CONTATORI ACQUA

CONTATORI A GETTO MULTIPLIO

CONTATORE PER ACQUA FREDDA



CERTIFICATO
MID
M1001

Installazione solo orizzontale. Quadrante a rulli protetti, con l'area di lettura non a contatto con l'acqua. Pressione nominale 16 bar. Temperatura massima di utilizzo 50°C. **Confezione completa di raccordi.** Non predisposto per emettitore impulsivi. A norma Europea EN 14154, direttiva 2004/22/CE (MID), certificazione di utilizzo con acque potabili DM 6/4/2004 n.174.

A richiesta: emettitore impulsivi P = 1-10-100 lt.
A richiesta: versione predisposto per radio 868 MHz (EN 13757) OMS.

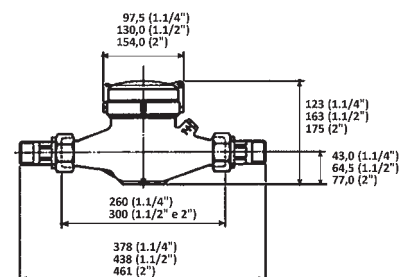

codice	Ø	Portata Q3 (m³/ora)	UM	min. ord.	conf.	cat.	prezzo (€)
● 1207134	1"1/4	10,0	NR	1	1	05	
● 1207135	1"1/2	16,0	NR	1	1	05	
● 1207136	2"	25,0	NR	1	1	05	

CONTATORI A MULINELLO

WOLTMANN PER ACQUA FREDDA PN16



CERTIFICATO
MID
M1001

Installazione orizzontale o verticale o inclinata. Estraibile. Trasmissione del movimento tramite giunto magnetico. Pressione nominale 10/16 bar. Temperatura massima di utilizzo 50°C. Predisposto per 2 uscite impulsive (una del tipo induttivo, una reed-switch), per installazione dell'emettitore di impulsi senza alterare la sigillatura. Predisposizione lancia impulsi: 1 impulso=100 litri (dal DN 50:100), 1 impulso=1.000 litri (dal DN 125:200). A norma Europea EN 14154, direttiva 2004/22/CE (MID), certificazione di utilizzo con acque potabili DM 6/4/2004 n.174.

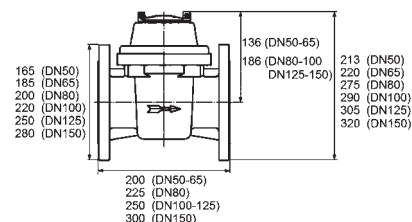

codice	Ø	Portata Q3 (m³/ora)	UM	min. ord.	conf.	cat.	prezzo (€)
● 1207151	50	25,0	NR	1	11		
● 1207152	65	40,0	NR	1	11		
● 1207153	80	63,0	NR	1	11		
● 1207154	100	100,0	NR	1	11		
● 1207155	125	160,0	NR	1	11		

codice	descrizione	UM	min. ord.	conf.	cat.	prezzo (€)
● 1207159	Emettitore di impulsi reed-switch	NR	1	11		



RUBINETTERIA DA ESTERNO

RUBINETTERIA DA ESTERNO

RUBINETTO A SFERA CON PORTAGOMMA

Leva alluminio



codice	Ø	UM	min. ord.	conf.	cat.	prezzo (€)
● 2009100	3/8"	NR	20	20	09	
● 2009101	1/2"	NR	25	25	09	
● 2009102	3/4"	NR	15	15	09	
● 2009103	1"	NR	1	10	09	

RUBINETTO A FARFALLA ANTIGHIACCIO CON PORTAGOMMA

Con sistema di regolazione del flusso.
Limite temperatura:
-10°C +100°C



codice	Ø	UM	min. ord.	conf.	cat.	prezzo (€)
● 2009120	1/2"	NR	25	25	04	
● 2009121	3/4"	NR	15	15	04	
● 2009122	1"	NR	1	10	04	

GIRELLO CON PORTAGOMMA E GUARNIZIONE

Ricambio per rubinetto 2009100-2009101-2009102-2009103-2009120-2009121-2009122



codice	Ø	UM	min. ord.	conf.	cat.	prezzo (€)
● 2009170	3/8" - 1/2"	NR	1	5	09	
● 2009171	3/4"	NR	1	5	09	
● 2009172	1"	NR	1	5	09	

RUBINETTO A SFERA PER IDRANTE

Con portagomma



codice	Ø	UM	min. ord.	conf.	cat.	prezzo (€)
● 2009165	1/2"	NR	1	30	04	
● 2009166	3/4"	NR	1	20	04	

RUBINETTO BRONZATO CON LEVA

A vitone passo-rapido
con guarnizione
in gomma.
Con raccordo per
portagomma



codice	Ø	UM	min. ord. conf.	cat.	prezzo (€)
● 2009010	1/2"	NR	1	22	

RUBINETTO BRONZATO CON VOLANTINO

A vitone normale.
Con raccordo per
portagomma



codice	Ø	UM	min. ord. conf.	cat.	prezzo (€)
● 2009011	1/2"	NR	1	22	

RUBINETTO LUCIDO CON LEVA

Con portagomma



codice	Ø	UM	min. ord. conf.	cat.	prezzo (€)
● 2009055	1/2"	NR	1	15	

RUBINETTO A PULSANTE

Contro colpo d'ariete



codice	Ø	UM	min. ord. conf.	cat.	prezzo (€)
● 2009060	1/2"	NR	1	15	

RUBINETTERIA DA ESTERNO

RUBINETTERIA DA ESTERNO

RUBINETTO LUCIDO CON CHIAVE ESTRAIBILE

Con portagomma



codice	Ø	UM	min. ord. conf.	cat.	prezzo (€)
● 2009041	1/2"	NR	1	15	

RUBINETTO LUCIDO

Con portagomma



codice	Ø	UM	min. ord. conf.	cat.	prezzo (€)
● 2009020	1/2"	NR	1	15	
● 2009021	3/4"	NR	1	15	

RUBINETTO SABBIAIO

Con portagomma



codice	Ø	UM	min. ord. conf.	cat.	prezzo (€)
● 2009081	1/2"	NR	1	15	

RUBINETTO SABBIAIO CROMATO

Con portagomma



codice	Ø	UM	min. ord. conf.	cat.	prezzo (€)
● 2009071	1/2"	NR	1	15	

RUBINETTO SABBIAIO CROMATO PASSORAPIDO

Con portagomma



codice	Ø	UM	min. ord. conf.	cat.	prezzo (€)
● 2009092	1/2"	NR	1	15	

RUBINETTI GALLEGGIANTI

RUBINETTI GALLEGGIANTI

RUBINETTO GALLEGGIANTE STAMPATO SEDE OTTONE

A 5 coppie, asta tonda in ottone D.5 mm.

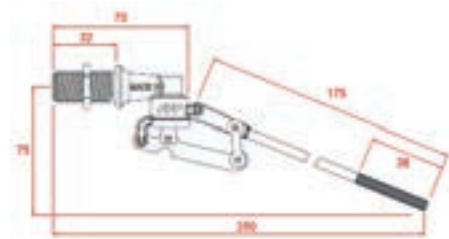

codice	sigla	Ø	sede	Ø sfera consigliata	UM	min. ord.	conf.	cat.	prezzo (€)
● 2012001	510/1.3/8	3/8"	ottone	90	NR	1	100	22	
● 2012002	510/1.1/2	1/2"	ottone	90	NR	1	100	22	

RUBINETTO GALLEGGIANTE STAMPATO / FUSO, SEDE OTTONE / INOX

A 5 coppie, asta piatta AISI 430

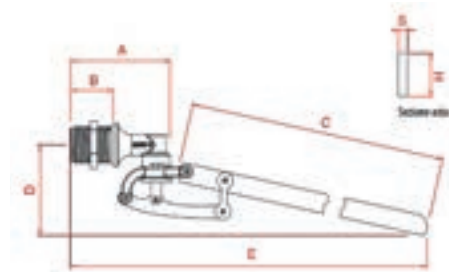

codice	sigla	Ø	corpo	sede	Ø sfera consigliata	UM	min. ord.	conf.	cat.	prezzo (€)
● 2012003	511/5.3/4	3/4"	stampato	ottone	120	NR	1	50	22	
● 2012004	511/5.1	1"	stampato	ottone	150	NR	1	30	22	
● 2012005	511/6.11/4	1"1/4	fuso	ottone	180	NR	1	10	22	
● 2012006	511/6.11/2	1"1/2	fuso	ottone	220	NR	1	10	22	
● 2012007	511/7.2	2"	fuso	ottone	220	NR	1	5	22	
● 2012890	511/10.3/4	3/4"	stampato	inox	120	NR	1	50	22	
● 2012891	511/10.1	1"	stampato	inox	150	NR	1	30	22	

Ø	mm							
	A	B	C	D	E	S	H	
3/4"	78	30	320	110	385	2,9	14	
1"	90	35	320	115	400	2,9	14	
1"1/4	120	43	500	120	600	3,8	18	
1"1/2	140	55	500	135	630	3,8	18	
2"	160	65	580	150	750	3,8	18	

RUBINETTO GALLEGGIANTE STAMPATO SEDE INOX

Asta tonda in ottone D.5 mm, REGOLABILE

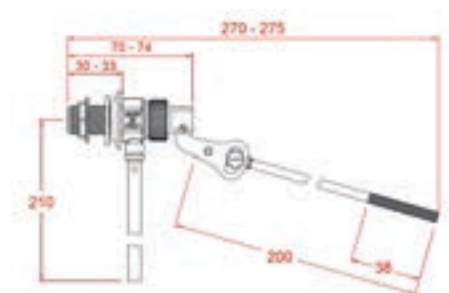

codice	sigla	Ø	Ø sfera consigliata	UM	min. ord.	conf.	cat.	prezzo (€)
● 2012201	516/2.3/8	3/8"	90	NR	1	100	22	
● 2012202	516/2.1/2	1/2"	90	NR	1	100	22	

RUBINETTI GALLEGGIANTI

RUBINETTI GALLEGGIANTI

RUBINETTO GALLEGGIANTE STAMPATO SEDE RESINA PDM

TIPO CATIS
Asta tonda in ottone
D.5 mm.

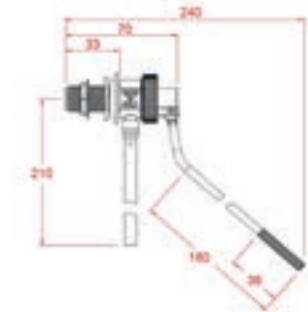

codice	sigla	Ø	Ø sfera consigliata	UM	min. ord.	conf.	cat.	prezzo (€)
2012833	518/3.3/8	3/8"	90	NR	1	100	22	
2012834	518/3.1/2	1/2"	90	NR	1	100	22	

RUBINETTO GALLEGGIANTE STAMPATO SEDE RESINA PDM, CON SFERA

TIPO CATIS. Asta tonda in ottone D.5 mm., completo di sfera in plastica piatta da D. 90

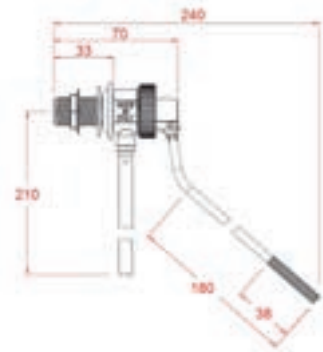

codice	sigla	Ø	UM	min. ord.	conf.	cat.	prezzo (€)
2012847	518/6.3/8+530/2	3/8"	NR	1	22		

RUBINETTO GALLEGGIANTE STAMPATO SEDE NYLON

Attacco alto, rubinetto d'arresto incorporato, asta sagomata AISI 430 REGOLABILE

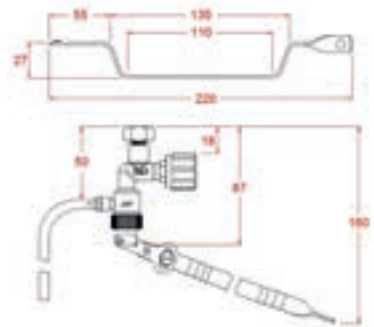

codice	sigla	Ø	Ø sfera consigliata	UM	min. ord.	conf.	cat.	prezzo (€)
2012401	519/1.3/8	3/8"	90	NR	1	50	22	

RUBINETTO GALLEGGIANTE STAMPATO SEDE INOX

Asta piatta AISI 430 REGOLABILE, completo di tubo di carico

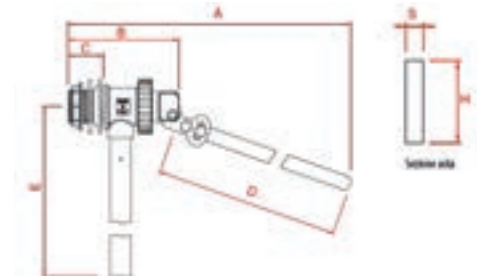

codice	sigla	Ø	Ø sfera consigliata	UM	min. ord.	conf.	cat.	prezzo (€)
2012101	523/1.3/4	3/4"	150	NR	1	30	22	
2012102	523/1.1	1"	180	NR	1	30	22	

Ø	mm						
	A	B	C	D	E	S	H
3/4"	390	92	35	320	320	2,9	14
1"	390	92	35	320	320	2,9	14

RUBINETTI GALLEGGIANTI

RUBINETTI GALLEGGIANTI

RUBINETTO GALLEGGIANTE STAMPATO / FUSO SEDE INOX

Per alte pressioni PN 12
Asta piatta AISI 430
REGOLABILE, completo di
tubo di carico

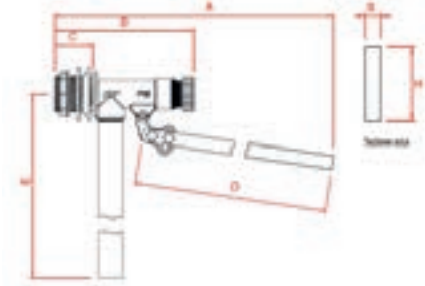

codice	sigla	Ø	corpo	Ø sfera consigliata	UM	min. ord.	conf.	cat.	prezzo (€)
● 2012821	524/1.3/4	3/4"	stampato	150	NR	1	30	22	
● 2012822	524/1.1	1"	stampato	180	NR	1	30	22	
● 2012823	524/2.11/4	1"1/4	fuso	220	NR	1	10	22	
● 2012824	524/2.11/2	1"1/2	fuso	220	NR	1	10	22	
● 2012825	524/2.2	2"	fuso	220	NR	1	5	22	

Ø	mm						
	A	B	C	D	E	S	H
3/4"	580	142-155	37	490	410	3,5	15
1"	580	142-155	37	490	410	3,5	15
1"1/4	690	177-190	40	580	410	3,8	18
1"1/2	700	182-195	50	580	410	3,8	18
2"	720	210-225	55	580	430	3,8	18

SFERA IN PLASTICA CON NOTTOLINO OTTONE



codice	Ø	UM	min. ord. conf.	cat.	prezzo (€)
● 2012501	90	NR	1	20	

SFERA IN PLASTICA CON SCORREVOLE



codice	Ø	UM	min. ord. conf.	cat.	prezzo (€)
● 2012601	120	NR	1	20	
● 2012602	150	NR	1	20	
● 2012603	180	NR	1	20	
● 2012604	220	NR	1	20	

SFERA IN PLASTICA PIATTA CON NOTTOLINO

Tipo Catis



codice	Ø	UM	min. ord. conf.	cat.	prezzo (€)
● 2012701	90	NR	1	20	

SFERA IN RAME CON REGGISFERA SALDATO



codice	Ø	UM	min. ord. conf.	cat.	prezzo (€)
● 2012722	1"- 150	NR	1	20	
● 2012723	1"1/4- 180	NR	1	20	

SFERA IN RAME CON NOTTOLINO



codice	Ø	UM	min. ord. conf.	cat.	prezzo (€)
● 2012711	90	NR	1	20	

CATALOGO
LISTINO N° 6

ACCESSORI CONDIZIONAMENTO

STAFFE PER CONDIZIONATORI	212
SCARICO CONDENZA	213
ACCESSORI CONDIZIONAMENTO	214
RACCORDERIA A PRESSARE IN RAME PER ARIA CONDIZIONATA E REFRIGERAZIONE	216

ACCESSORI
CONDIZIONAMENTO

ACCESSORI CONDIZIONAMENTO

STAFFE PER CONDIZIONATORI

MENSOLA UNIVERSALE PER CONDIZIONATORI

In lamiera zincata spessore 15/10, verniciata con polveri poliesteri (RAL 9002), premontate, ad aggancio regolabile.

Fornite con livella, piedini posteriori regolabili, antivibranti, tasselli di fissaggio.

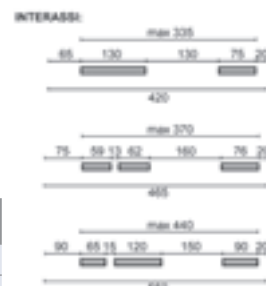

codice	Dimensioni (mm)	Portata (kg)	UM	min. ord.	pz. pallet	cat.	prezzo (€)
● 5850020	P420 x H400 x L800	120	NR	1	150	06	
● 5850021	P465 x H400 x L800	160	NR	1	150	06	
● 5850023	P550 x H400 x L800	160	NR	1	60	06	

STAFFA A TETTO

In lamiera zincata, verniciata con polveri poliesteri (RAL 9002), regolabile con inclinazione da 15° a 30°.

Fornita con gommini antivibranti e viteria.

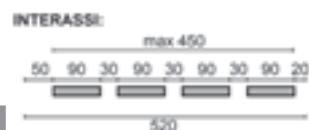

codice	Dimensioni (mm)	Portata (kg)	UM	min. ord. conf.	cat.	prezzo (€)
● 5850040	P520 x L850	15° = 80 30° = 150	NR	1	06	

POMPA SCARICO CONDENSA SANICONDENS CLIM MINI NEW SILENCE

Minipompa interna per split di condizionatori fino a 8 Kw, con sistema di allarme contro le fuoriuscite, perfettamente intercambiabile con modello precedente. A corredo: tubo flessibile da 1,2 mt., supporto di fissaggio, tubo di sfiato, cavi di alimentazione e di allarme.

Applicazioni: split

Capacità di scarico: 6 metri in verticale (tubo Ø 8/10 mm.)
60 metri in orizzontale (tubo Ø 8/10 mm.)

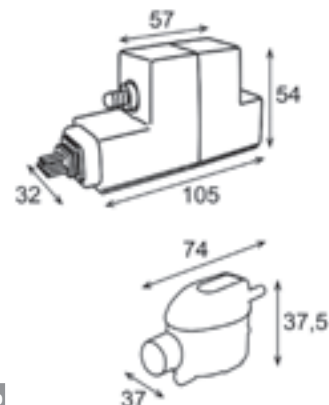

codice	sigla	Portata max	Livello sonoro	UM	min. ord.	conf.	cat.	prezzo (€)
● 3350020	SCONCLIMS	9 lt/h	21dB(A)	NR	1	12	13	

POMPA SCARICO CONDENSA A PISTONE

Adatto per climatizzatori fino a 20Kw. Pompa a pistone, livello sonoro ridotto indipendentemente dal volume di condensa da scaricare. A corredo: piastrina di fissaggio pompa per montaggio a parete, sulle tubazioni o in sospensione.

Cavo di alimentazione da 0,8 mt, tubo pvc trasparente da 1,5 mt Ø int. 6 mm; kit installazione.

Applicazioni: split

Capacità di scarico verticale: 10 metri (portata 4 lt/h)



codice	sigla	Portata max	Livello sonoro	UM	min. ord.	conf.	cat.	prezzo (€)
● 3351023	SI27CE01UN23	20 lt/h	20dB(A)	NR	1	20	03	

SIFONE SCARICO CONDENSA DA INCASSO CON PLACCA BIANCA

Con pallina di chiusura per i periodi di inutilizzo in cui evapora l'acqua.



codice	sigla	UM	min. ord.	conf.	cat.	prezzo (€)
● 2401101	2370.273.4.	NR	1	15	01	

ACCESSORI CONDIZIONAMENTO

SCARICO CONDENSA

SIFONE SCARICO CONDENSA ESTERNO



Con pallina di chiusura per i periodi di inutilizzo in cui evapora l'acqua.



	codice	sigla	UM	min. ord.	conf.	cat.	prezzo (€)
●	2401001	2370.162.4.	NR	1	30	01	

SIFONE SCARICO CONDENSA DA INCASSO CON PLACCA INOX



Con pallina di chiusura per i periodi di inutilizzo in cui evapora l'acqua. Doppio attacco, diritto e curvo.



	codice	sigla	UM	min. ord.	conf.	cat.	prezzo (€)
●	2401004	2370.185.4	NR	1	30	01	

ACCESSORI CONDIZIONAMENTO

BASE A PAVIMENTO



In PVC rigido antiurto, autoestinguente e stabilizzato contro i raggi UV. Compreso fasce adesive antiscivolo e antivibrazione coestruse. Colore avorio

	codice	descrizione	Portata (kg)	misura (mm)	UM	min. ord. conf.	cat.	prezzo (€)
●	5850052	Base a pavimento	140	L350xH80	NR	12	06	
●	5850050	Base a pavimento	140	L450xH80	NR	12	06	
●	5850051	Tappo x base pavimento	-	L80xH80	NR	4	06	

KIT ANTIVIBRANTI

Kit composto da 4 antivibranti, con relativi dadi a rondelle.



	codice	descrizione	misura (mm)	Fig.	UM	min. ord. conf.	cat.	prezzo (€)
●	5850060	Per staffe	39x22	1	NR	20	06	
●	5850061	A pavimento	40x40	2	NR	20	06	

TELO PROTETTIVO PER UNITA' ESTERNE

Cover in busta minigrip, materiali cuciti e bordati.



codice	Dimensioni (mm)	adattabilità unità	UM	min. ord. conf.	cat.	prezzo (€)
● 5850082	L800 x H650 x P350	Dual	NR	1	06	
● 5850084	L950 x H750 x P400	Quadri	NR	1	06	

CLIMAFOAM SPRAY

Detergente schiumogeno per condizionatori per la pulizia dei pacchi alettati e dei filtri delle unità interne degli impianti di aria condizionata. Disgrega lo sporco ed emulsionandolo permette di eliminarlo facilmente.



codice	contenuto (ml)	UM	min. ord. conf.	cat.	prezzo (€)
● 2006010	500	NR	12	02	

CONDIBAT SPRAY

Sanificante e igienizzante per condizionatori, fan coil e piccoli ambienti in soluzione alcolica >70% in combinazione con sostanze fenoliche. Testato secondo il metodo UNI EN 1040:2005



PROPRIETA' CHIMICO FISICHE	VALORI
Forma	Aerosol
Colore	Incolore
Odore	Fiori di campo
pH	11,25 ± 0,25
Solubilità/Miscibilità acqua	Poco solubile
VOC (%)	50,40

codice	contenuto (ml)	UM	min. ord. conf.	cat.	prezzo (€)
● 2006011	500	NR	12	02	

NASTRO ADESIVO ANTICONDENSA

In elastomero



codice	spess. (mm)	altezza (mm)	lungh. (mt)	UM	min. ord. conf.	cat.	prezzo (€)
● 2006341	3	50	10	NR	24	19	
● 2006340	3	50	15	NR	12	19	

CURVETTA IN PP

Per sifone scarico condensa esterno (2401001)



codice	sigla	Ø	UM	min. ord. conf.	cat.	prezzo (€)
● 2661017	2111.100.4.	1"	NR	10	20	

ACCESSORI CONDIZIONAMENTO

RACCORDERIA A PRESSURE IN RAME ARIA CONDIZIONATA E REFRIGERAZIONE



Conforme alla normativa EN 378-2
Elastomero in HNBR nero (EN549)

- Misure in pollici
- Profilo di pressatura BMP

Raccordi in rame per aria condizionata e refrigerazione fino a 48 bar, vuoto 200 micron, temperatura -40°C / +121°C.

CURVA A 90° M/F



codice	sigla	Ø	UM	min. ord. conf.	cat.	prezzo (€)
6750001	MPA5001 0030001	3/8"	NR	3	10	
6750002	MPA5001 0040001	1/2"	NR	3	10	
6750003	MPA5001 0050001	5/8"	NR	3	10	
6750004	MPA5001 0060001	3/4"	NR	3	10	
6750005	MPA5001 0070001	7/8"	NR	3	10	
6750006	MPA5001 0080001	1"	NR	2	10	
6750007	MPA5001 0090001	1"1/8	NR	2	10	
6750008	MPA5001 0110001	1"3/8	NR	1	10	

CURVA A 90° F/F



codice	sigla	Ø	UM	min. ord. conf.	cat.	prezzo (€)
6751001	MPA5002 0020001	1/4"	NR	5	10	
6751002	MPA5002 0030001	3/8"	NR	5	10	
6751003	MPA5002 0040001	1/2"	NR	3	10	
6751004	MPA5002 0050001	5/8"	NR	3	10	
6751005	MPA5002 0060001	3/4"	NR	3	10	
6751006	MPA5002 0070001	7/8"	NR	3	10	
6751007	MPA5002 0080001	1"	NR	2	10	
6751008	MPA5002 0090001	1"1/8	NR	2	10	
6751009	MPA5002 0110001	1"3/8	NR	1	10	

CURVA A 45° F/F



codice	sigla	Ø	UM	min. ord. conf.	cat.	prezzo (€)
6752001	MPA5041 0020001	1/4"	NR	3	10	
6752002	MPA5041 0030001	3/8"	NR	3	10	
6752003	MPA5041 0040001	1/2"	NR	3	10	
6752004	MPA5041 0050001	5/8"	NR	3	10	
6752005	MPA5041 0060001	3/4"	NR	3	10	
6752006	MPA5041 0070001	7/8"	NR	3	10	
6752007	MPA5041 0080001	1"	NR	2	10	
6752008	MPA5041 0090001	1"1/8	NR	2	10	
6752009	MPA5041 0110001	1"3/8	NR	2	10	

MANICOTTO CON BATTUTA F/F



codice	sigla	Ø	UM	min. ord. conf.	cat.	prezzo (€)
6756001	MPA5270 0020001	1/4"	NR	5	10	
6756002	MPA5270 0030001	3/8"	NR	5	10	
6756003	MPA5270 0040001	1/2"	NR	5	10	
6756004	MPA5270 0050001	5/8"	NR	5	10	
6756005	MPA5270 0060001	3/4"	NR	2	10	
6756006	MPA5270 0070001	7/8"	NR	2	10	
6756007	MPA5270 0080001	1"	NR	2	10	
6756008	MPA5270 0090001	1"1/8	NR	2	10	
6756009	MPA5270 0110001	1"3/8	NR	2	10	

MANICOTTO PASSANTE F/F



codice	sigla	Ø	UM	min. ord. conf.	cat.	prezzo (€)
6758001	MPA5275L0020001	1/4"	NR	5	10	
6758002	MPA5275L0030001	3/8"	NR	5	10	
6758003	MPA5275L0040001	1/2"	NR	5	10	
6758004	MPA5275L0050001	5/8"	NR	3	10	
6758005	MPA5275L0060001	3/4"	NR	2	10	
6758006	MPA5275L0070001	7/8"	NR	2	10	
6758007	MPA5275L0080001	1"	NR	1	10	
6758008	MPA5275L0090001	1"1/8	NR	1	10	

ACCESSORI CONDIZIONAMENTO

RACCORDERIA A PRESSARE IN RAME ARIA CONDIZIONATA E REFRIGERAZIONE

MANICOTTO RIDOTTO F/F



codice	sigla	Ø	UM	min. ord. conf.	cat.	prezzo (€)
6753001	MPA5240 0030201	3/8"x1/4"	NR	2	10	
6753002	MPA5240 0040201	1/2"x1/4"	NR	2	10	
6753003	MPA5240 0040301	1/2"x3/8"	NR	2	10	
6753004	MPA5240 0050301	5/8"x3/8"	NR	2	10	
6753005	MPA5240 0050401	5/8"x1/2"	NR	2	10	
6753006	MPA5240 0060301	3/4"x3/8"	NR	2	10	
6753007	MPA5240 0060401	3/4"x1/2"	NR	2	10	
6753008	MPA5240 0060501	3/4"x5/8"	NR	2	10	
6753009	MPA5240 0070401	7/8"x1/2"	NR	2	10	
6753010	MPA5240 0070501	7/8"x5/8"	NR	2	10	
6753011	MPA5240 0070601	7/8"x3/4"	NR	2	10	
6753012	MPA5240 0080601	1"x3/4"	NR	1	10	
6753013	MPA5240 0090501	1"1/8x5/8"	NR	1	10	
6753014	MPA5240 0090601	1"1/8x3/4"	NR	1	10	
6753015	MPA5240 0090701	1"1/8x7/8"	NR	1	10	
6753016	MPA5240 0090801	1"1/8x1"	NR	1	10	
6753017	MPA5240 0110701	1"3/8x7/8"	NR	1	10	
6753018	MPA5240 0110801	1"3/8x1"	NR	1	10	
6753019	MPA5240 0110901	1"3/8x1"1/8"	NR	1	10	

MANICOTTO RIDOTTO M/F



codice	sigla	Ø	UM	min. ord. conf.	cat.	prezzo (€)
6755001	MPA5243 0030201	3/8"x1/4"	NR	2	10	
6755002	MPA5243 0040301	1/2"x3/8"	NR	2	10	
6755003	MPA5243 0050301	5/8"x3/8"	NR	2	10	
6755004	MPA5243 0050401	5/8"x1/2"	NR	2	10	
6755005	MPA5243 0060501	3/4"x5/8"	NR	2	10	
6755006	MPA5243 0070401	7/8"x1/2"	NR	2	10	
6755007	MPA5243 0070501	7/8"x5/8"	NR	2	10	
6755008	MPA5243 0070601	7/8"x3/4"	NR	2	10	
6755009	MPA5243 0090401	1"1/8x1/2"	NR	1	10	
6755010	MPA5243 0090501	1"1/8x5/8"	NR	1	10	
6755011	MPA5243 0090601	1"1/8x3/4"	NR	1	10	
6755012	MPA5243 0090701	1"1/8x7/8"	NR	1	10	
6755013	MPA5243 0110701	1"3/8x7/8"	NR	1	10	
6755014	MPA5243 0110801	1"3/8x1"	NR	1	10	
6755015	MPA5243 0110901	1"3/8x1"1/8"	NR	1	10	

TAPPO F



codice	sigla	Ø	UM	min. ord. conf.	cat.	prezzo (€)
6763001	MPA5301 0020001	1/4"	NR	3	10	
6763002	MPA5301 0030001	3/8"	NR	3	10	
6763003	MPA5301 0040001	1/2"	NR	3	10	
6763004	MPA5301 0050001	5/8"	NR	2	10	
6763005	MPA5301 0060001	3/4"	NR	2	10	
6763006	MPA5301 0070001	7/8"	NR	2	10	
6763007	MPA5301 0080001	1"	NR	1	10	
6763008	MPA5301 0090001	1"1/8"	NR	1	10	
6763009	MPA5301 0110001	1"3/8"	NR	1	10	

MISURATORE DI PROFONDITÀ E PENNARELLO



codice	sigla	Ø	UM	min. ord. conf.	cat.	prezzo (€)
6766001	MPA DEPTH GAUGE	1/4" - 1"3/8"	NR	1	10	

LUBRIFICANTE PER O-RING 100ml



codice	sigla	UM	min. ord. conf.	cat.	prezzo (€)	
6766002	MPABPSOIL100ML	NR	1	25	10	

TEE F/F /F



codice	sigla	Ø	UM	min. ord. conf.	cat.	prezzo (€)
6764001	MPA5T 002020201	1/4"	NR	3	10	
6764002	MPA5T 003030301	3/8"	NR	3	10	
6764003	MPA5T 004040401	1/2"	NR	3	10	
6764004	MPA5T 005050501	5/8"	NR	2	10	
6764005	MPA5T 006060601	3/4"	NR	2	10	
6764006	MPA5T 007070701	7/8"	NR	2	10	
6764007	MPA5T 008080801	1"	NR	1	10	
6764008	MPA5T 009090901	1"1/8"	NR	1	10	
6764009	MPA5T 011111101	1"3/8"	NR	1	10	

MANICOTTO CARTELLATO IN RAME, DADO GIREVOLE IN OTTONE



codice	sigla	Ø	UM	min. ord. conf.	cat.	prezzo (€)
6759001	MPA5285G0020201	1/4"	NR	4	10	
6759002	MPA5285G0030301	3/8"	NR	4	10	
6759003	MPA5285G0040401	1/2"	NR	2	10	
6759004	MPA5285G0050501	5/8"	NR	2	10	
6759005	MPA5285G0060601	3/4"	NR	2	10	

CATALOGO
LISTINO N° 6

RISCALDAMENTO

SCALDABAGNI	220
TERMOARREDO ELETTRICO	222
TERMOARREDO	224
RADIATORI IN ALLUMINIO	228
ACCESSORI RADIATORI	237
CIRCOLATORI	241
ACCESSORI SOTTOCALDAIA	242
RIDUTTORI DI PRESSIONE	247
MANOMETRI E TERMOMETRI	248



SCALDABAGNI

SCALDABAGNI ELETTRICI

SCALDABAGNO ELETTRICO VERTICALE - GARANZIA 5 ANNI

Realizzati in acciaio di alta qualità, trattamento interno di vetroporcellanatura in polvere, isolamento in schiuma poliuretanicopriva di CFC. Dotato di resistenza elettrica ultraperformante con speciale trattamento superficiale che riduce quasi del tutto le incrostazioni. Controllo termostatico a sonda. Anodo di magnesio a protezione del serbatoio. Flangia a 5 bulloni. Indicatore livello di temperatura e spia on/off. Valvola di sicurezza tarata a 8 bar.



ERP

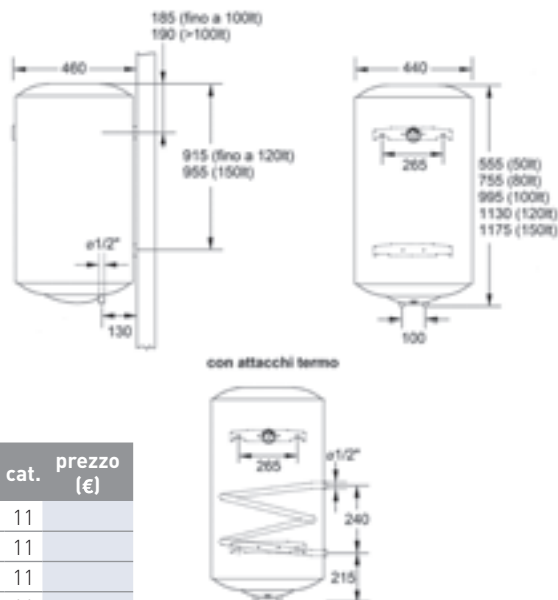

codice	TIPO	LITRI	Classe ERP	Watt	Profilo di carico	UM	min. ord. conf.	cat.	prezzo (€)
6170001	Verticale	50	C	1200	M	NR	1	11	
6170002	Verticale	80	C	1200	L	NR	1	11	
6170003	Verticale	100	C	1500	L	NR	1	11	
6170006	Verticale	120	C	1500	L	NR	1	11	
6170007	Verticale	150	C	1500	L	NR	1	11	
6170004	Termoelettrico - attacchi DX	80	C	1200	L	NR	1	11	
6170005	Termoelettrico - attacchi SX	80	C	1200	L	NR	1	11	

SCALDABAGNO ELETTRICO ORIZZONTALE - GARANZIA 5 ANNI

Realizzati in acciaio di alta qualità, trattamento interno di vetroporcellanatura in polvere, isolamento in schiuma poliuretanicopriva di CFC. Dotato di resistenza elettrica ultraperformante con speciale trattamento superficiale che riduce quasi del tutto le incrostazioni. Controllo termostatico a sonda. Anodo di magnesio a protezione del serbatoio. Flangia a 5 bulloni. Indicatore livello di temperatura e spia on/off. Valvola di sicurezza tarata a 8 bar.



ERP

VERSIONE RESISTENZA DESTRA

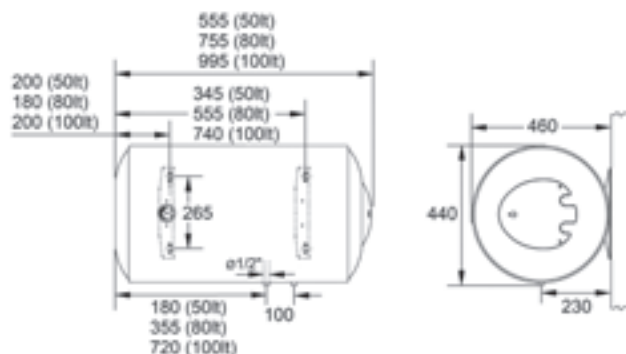

codice	TIPO	LITRI	Classe ERP	Watt	Profilo di carico	UM	min. ord. conf.	cat.	prezzo (€)
6172005	Resistenza DESTRA	50	C	1200	M	NR	1	11	
6172006	Resistenza SINISTRA	50	C	1200	M	NR	1	11	
6172001	Resistenza DESTRA	80	C	1200	M	NR	1	11	
6172002	Resistenza SINISTRA	80	C	1200	M	NR	1	11	
6172003	Resistenza DESTRA	100	C	1500	L	NR	1	11	
6172004	Resistenza SINISTRA	100	C	1500	L	NR	1	11	
6171006	Termoelettrico - attacchi DX	80	C	1200	M	NR	1	11	
6171007	Termoelettrico - attacchi SX	80	C	1200	M	NR	1	11	

SCALDABAGNO ELETTRICO - GARANZIA 5 ANNI

Bollitore vetroporcellanato con trattamento igienizzante. Resistenza elettrica in acciaio inossidabile. Anodo di magnesio. Regolatore della temperatura esterno con indicatore della potenza a led. Involucro esterno in ABS. Termostato a capillare per il controllo della temperatura.

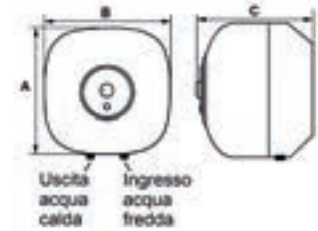

codice	TIPO	LITRI	Classe ERP	Watt	Profilo di carico	UM	min. ord. conf.	cat.	prezzo (€)
6171001	SOPRA lavello	10	B	1500	XXS	NR	1	11	
6171002	SOTTO lavello	10	C	1500	XXS	NR	1	11	
6171003	SOPRA lavello	15	B	1500	XXS	NR	1	11	
6171004	SOTTO lavello	15	C	1500	XXS	NR	1	11	
6171005	SOPRA lavello	30	C	1500	S	NR	1	11	

codice	A	B	C
6171001	240	291	347
6171002	240	291	347
6171003	360	329	375
6171004	360	329	375
6171005	440	389	455

ACCESSORI E RICAMBI SCALDABAGNI ELETTRICI

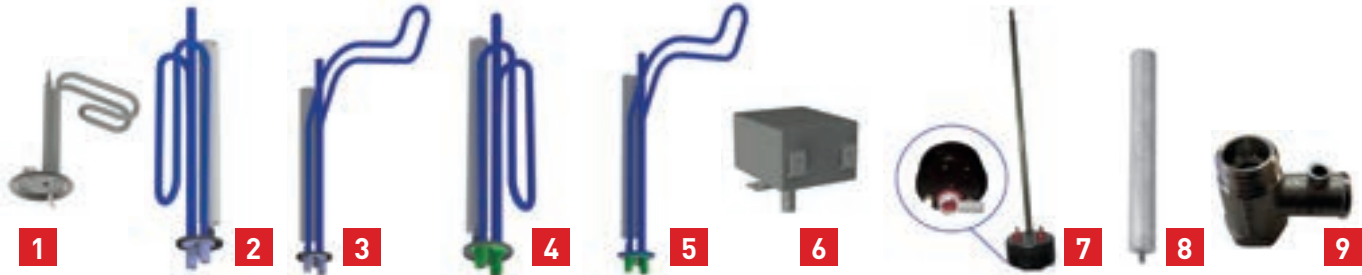

codice	descrizione	compatibilità scaldabagno			garanzia (Anni)	foto	UM	min. ord. conf.	cat.	prezzo (€)
		modelli	versione							
2008051	Resistenza flangiata 1500w (Conf.5pz)	10-15-30	-		2-5	1	CF	1	01	
2008056	Resistenza flangiata 1200w (Conf.10pz)	50-80	verticale		5	2	CF	1	01	
2008060	Resistenza flangiata 1200w (Conf.10pz)	50-80	orizzontale		5	3	CF	1	01	
2008057	Resistenza flangiata 1500w (Conf.10pz)	100-120-150	verticale		5	4	CF	1	01	
2008061	Resistenza flangiata 1500w (Conf.10pz)	100-120-150	orizzontale		5	5	CF	1	01	
2008052	Termostato capillare (Conf.10pz)	10-15-30	-		2-5	6	CF	1	01	
2008062	Termostato (Conf.10pz)	50-80-100-120-150	verticale		2-5	7	CF	1	01	
2008063	Termostato (Conf.10pz)	50-80-100-120-150	orizzontale		2-5	7	CF	1	01	
2008050	Anodo 17 x 130 (Conf.5pz)	10-15-30	-		2-5	8	CF	1	01	
2008064	Anodo 21,3 x 220 (Conf.5pz)	50-80-100-120-150	vertic./orizz.		2-5	8	CF	1	01	
2008065	Valvola di sicurezza 1/2" - 8 bar	tutti	vertic./orizz.		2-5	9	NR	1	01	

RACCORDI PER SCALDABAGNO



Con tubi e squadretta in rame cromato, biconi D. 14

codice	sigla	attacco Ø	UM	min. ord. conf.	cat.	prezzo (€)
2733010	0905R442CR	1/2"x1/2"	NR	1	06	



TRADIZIONALE RUBINETTO PER SCALDABAGNO



Incluso tubo di collegamento

codice	UM	min. ord. conf.	cat.	prezzo (€)
3005028	NR	1	03	

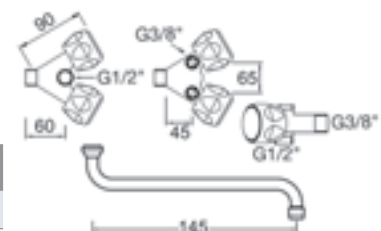

TERMOARREDO ELETTRICO

MODELLO CLOE

ELETTRICO BIANCO

Termoarredo in acciaio al carbonio, collettori laterali Ø 40x30 mm., saldobrasati, con cronotermostato digitale. Con kit di fissaggio incluso. Verniciatura a polveri epossipoliestere. Temperatura max d'esercizio 90°C. Grado protezione IP24. Isolamento elettrico Classe 2. Spina Schuko.



Cronotermostato digitale con sensore per la rilevazione della temperatura ambiente impostata ed ampio display per visualizzare tutte le funzioni (non retroilluminato).

Progettato per essere conforme alla nuova direttiva Europea ErP (Energy-related-Products) per il risparmio energetico.

Il termostato presenta le seguenti modalità di funzionamento:

- Modalità "Comfort": mantenimento della temperatura ambiente impostata dall'utente;
- Modalità "Crono": programmazione del funzionamento giornaliero con ripetizione settimanale;
- Modalità "2h": il radiatore funziona alla massima potenza per 2h indipendentemente dalla temperatura impostata;
- Modalità "Antigelo": mantenimento della temperatura ambiente sempre sopra i 7°C;
- Modalità "Notte": mantenimento della temperatura ambiente ad un valore ridotto rispetto alla temperatura Comfort;
- Rilevamento "Finestra aperta": il termostato si disattiva per un massimo di 30 minuti nel caso di apertura di una finestra all'interno della stanza;

BIANCO

codice	altezza (mm)	larghezza (mm)	peso (kg)	Resistenza (Watt)	UM	min. ord.	pz. pallet	cat.	prezzo (€)
● 6122001	720	400	7,7	300	NR	1	20	02	
● 6122002	920	480	9,4	500	NR	1	20	02	
● 6122003	1375	480	14,7	750	NR	1	20	02	
● 6122004	1703	550	22,1	1000	NR	1	9	02	

ELETTRICO CROMATO

Termoarredo in acciaio al carbonio, collettori laterali Ø 40x30 mm., saldobrasati, con cronotermostato digitale. Con kit di fissaggio incluso. Verniciatura a polveri epossipoliestere. Temperatura max d'esercizio 90°C. Grado protezione IP24. Isolamento elettrico Classe 2. Spina Schuko.

PRODOTTO CONFORME
ALLA NUOVA DIRETTIVA



CROMATO

Ø 22

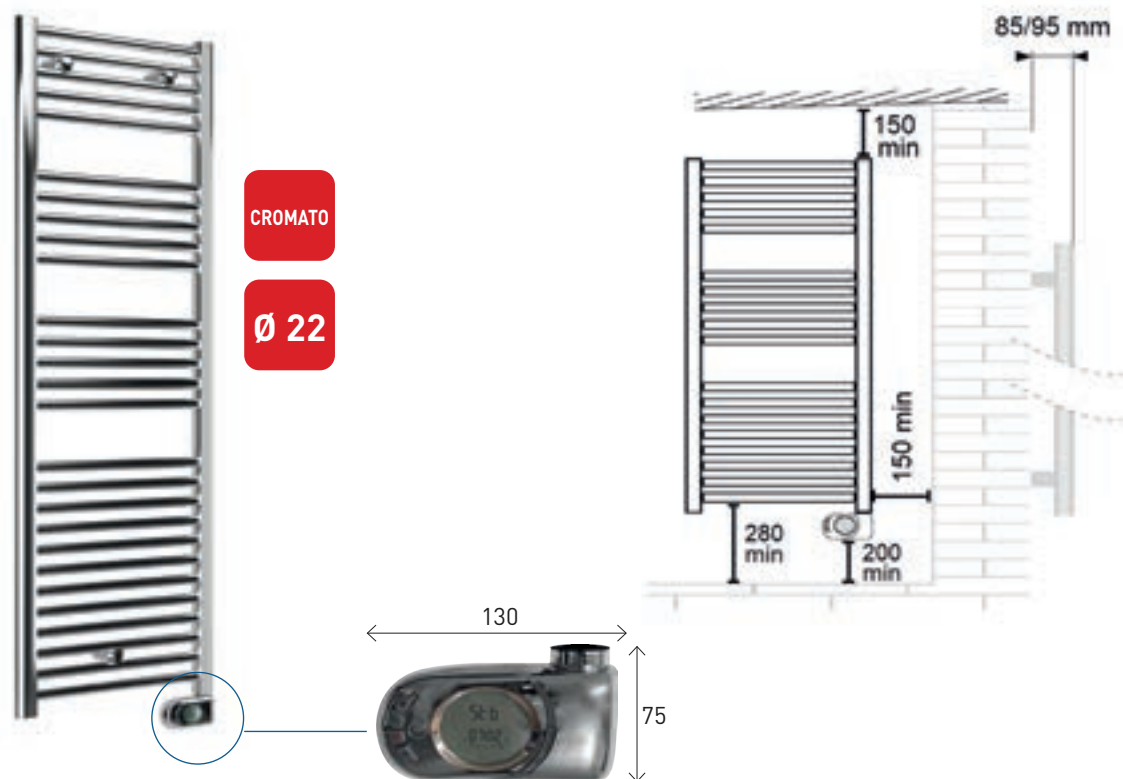

Cronotermostato digitale con sensore per la rilevazione della temperatura ambiente impostata ed ampio display per visualizzare tutte le funzioni (non retroilluminato).

Progettato per essere conforme alla nuova direttiva Europea ErP (Energy-related-Products) per il risparmio energetico.

Il termostato presenta le seguenti modalità di funzionamento:

- Modalità "Comfort": mantenimento della temperatura ambiente impostata dall'utente;
- Modalità "Crono": programmazione del funzionamento giornaliero con ripetizione settimanale;
- Modalità "2h": il radiatore funziona alla massima potenza per 2h indipendentemente dalla temperatura impostata;
- Modalità "Antigelo": mantenimento della temperatura ambiente sempre sopra i 7°C;
- Modalità "Notte": mantenimento della temperatura ambiente ad un valore ridotto rispetto alla temperatura Comfort;
- Rilevamento "Finestra aperta": il termostato si disattiva per un massimo di 30 minuti nel caso di apertura di una finestra all'interno della stanza;

CROMATO

codice	altezza (mm)	larghezza (mm)	peso (kg)	Resistenza (Watt)	UM	min. ord.	pz. pallet	cat.	prezzo (€)
6122011	720	400	7,7	150	NR	1	20	03	
6122012	920	480	9,4	300	NR	1	20	03	
6122013	1375	480	14,7	400	NR	1	20	03	
6122014	1703	550	22,1	600	NR	1	9	03	

TERMOARREDO

MODELLO GIULIA

BIANCO

Termoarredo in acciaio al carbonio, collettori laterali Ø 40x30 mm., saldobrasati. Con kit di fissaggio incluso.

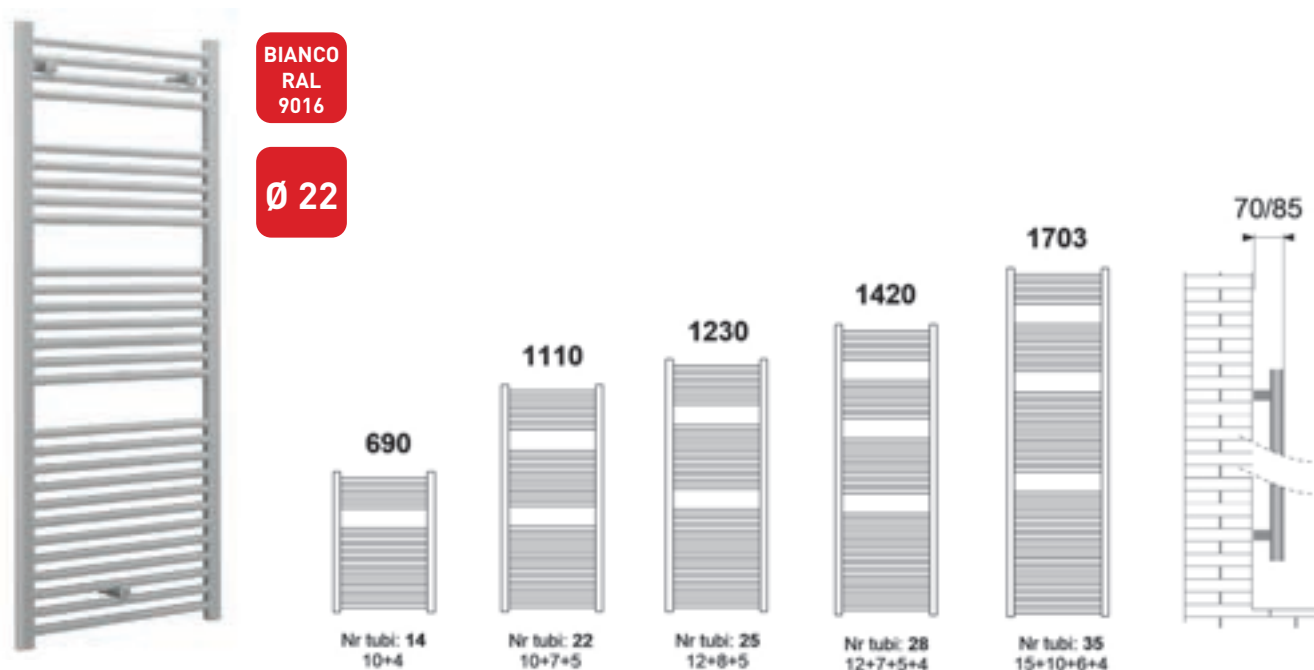

BIANCO

codice	altezza (mm)	larghezza (mm)	interasse (mm)	watt		peso (kg)	contenuto acqua (litri)	Resistenza (Watt)	UM	min. ord.	cat.	prezzo (€)
				Δt 30°C	Δt 50°C							
6100001	690	450	405	162	301	5,1	2,9	300	NR	1	02	
6100002	690	500	455	177	330	5,5	3,2	300	NR	1	02	
6100003	690	550	505	192	358	5,9	3,4	300	NR	1	02	
6100004	690	600	555	207	386	6,2	3,6	300	NR	1	02	
6100005	1110	450	405	249	468	8,0	4,7	500	NR	1	02	
6100006	1110	500	455	272	512	8,6	5,0	500	NR	1	02	
6100007	1110	550	505	294	555	9,2	5,4	500	NR	1	02	
6100008	1110	600	555	318	599	9,8	5,7	700	NR	1	02	
6100018	1230	450	405	276	522	10,1	5,6	500	NR	1	02	
6100019	1230	500	455	302	571	10,9	6,0	500	NR	1	02	
6100009	1420	450	405	323	611	10,2	5,9	700	NR	1	02	
6100010	1420	500	455	354	669	11,0	6,4	700	NR	1	02	
6100011	1420	550	505	385	727	11,7	6,8	700	NR	1	02	
6100012	1420	600	555	415	784	12,5	7,3	700	NR	1	02	
6100013	1703	450	405	387	733	12,5	7,3	700	NR	1	02	
6100014	1703	500	455	424	802	13,5	7,8	700	NR	1	02	
6100015	1703	550	505	461	871	14,4	8,4	1000	NR	1	02	
6100016	1703	600	555	498	940	15,4	9,0	1000	NR	1	02	
6100017	1703	750	705	609	1147	18,3	10,7	1000	NR	1	02	

BIANCO

Termoarredo in acciaio al carbonio, collettori laterali Ø 40x30 mm., saldobrasati. Con kit di fissaggio incluso.

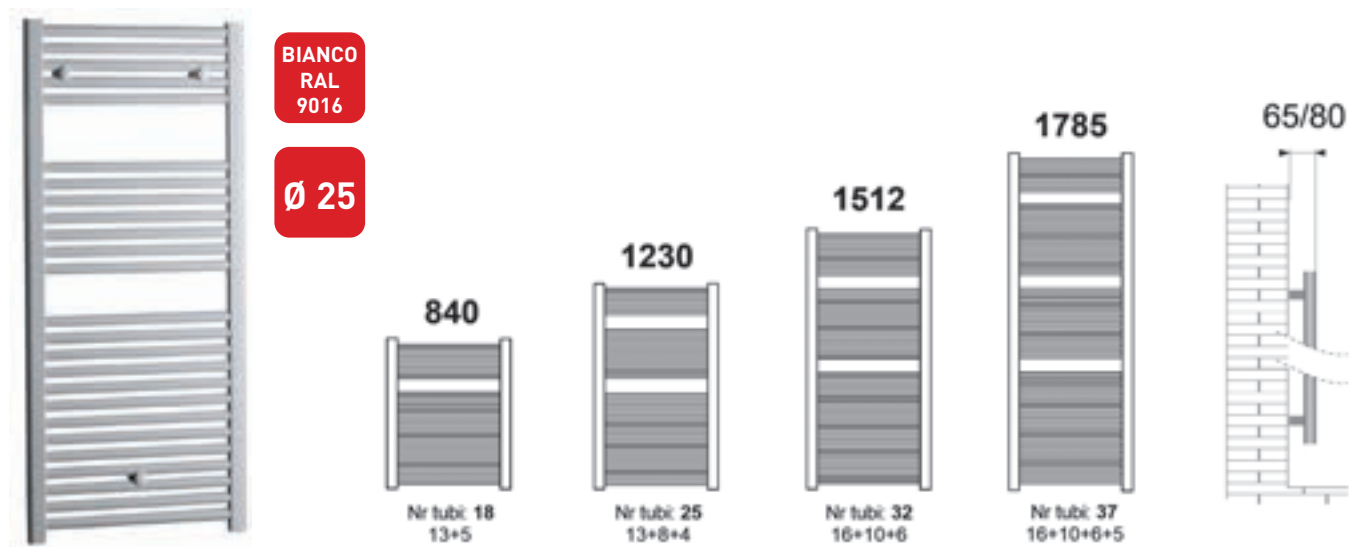

BIANCO

codice	altezza (mm)	larghezza (mm)	interasse (mm)	watt		peso (kg)	contenuto acqua (litri)	Resistenza (Watt)	UM	min. ord.	cat.	prezzo (€)
				Δt 30°C	Δt 50°C							
6101001	840	400	355	184	342	6,3	4,0	300	NR	1	15	
6101002	840	450	405	207	385	6,9	4,4	300	NR	1	15	
6101003	840	500	455	229	426	7,5	4,7	500	NR	1	15	
6101004	840	550	505	251	467	8,0	5,1	500	NR	1	15	
6101005	840	600	555	273	508	8,6	5,5	500	NR	1	15	
6101009	1230	400	355	253	478	9,0	5,6	500	NR	1	15	
6101010	1230	450	405	285	538	9,7	6,2	500	NR	1	15	
6101011	1230	500	455	320	605	10,5	6,7	700	NR	1	15	
6101012	1230	550	505	356	673	11,3	7,2	700	NR	1	15	
6101013	1230	600	555	391	740	12,1	7,8	700	NR	1	15	
6101015	1230	750	705	497	942	14,5	9,3	1000	NR	1	15	
6101017	1512	400	355	310	585	11,2	7,1	700	NR	1	15	
6101018	1512	450	405	348	658	12,3	7,8	700	NR	1	15	
6101019	1512	500	455	390	736	13,3	8,5	700	NR	1	15	
6101020	1512	550	505	430	813	14,3	9,1	700	NR	1	15	
6101021	1512	600	555	471	890	15,3	9,8	1000	NR	1	15	
6101023	1512	750	705	594	1122	18,3	11,8	1000	NR	1	15	
6101025	1785	400	355	370	697	13,1	8,3	700	NR	1	15	
6101026	1785	450	405	416	784	14,3	9,1	700	NR	1	15	
6101027	1785	500	455	458	863	15,4	9,9	1000	NR	1	15	
6101028	1785	550	505	500	942	16,6	10,6	1000	NR	1	15	
6101029	1785	600	555	541	1020	17,8	11,4	1000	NR	1	15	
6101031	1785	750	705	668	1257	21,2	13,8	1000	NR	1	15	

TERMOARREDO

MODELLO GIADA

CROMATO

Termoarredo in acciaio al carbonio, collettori laterali Ø 40x30 mm., saldobrasati. Con kit di fissaggio incluso.

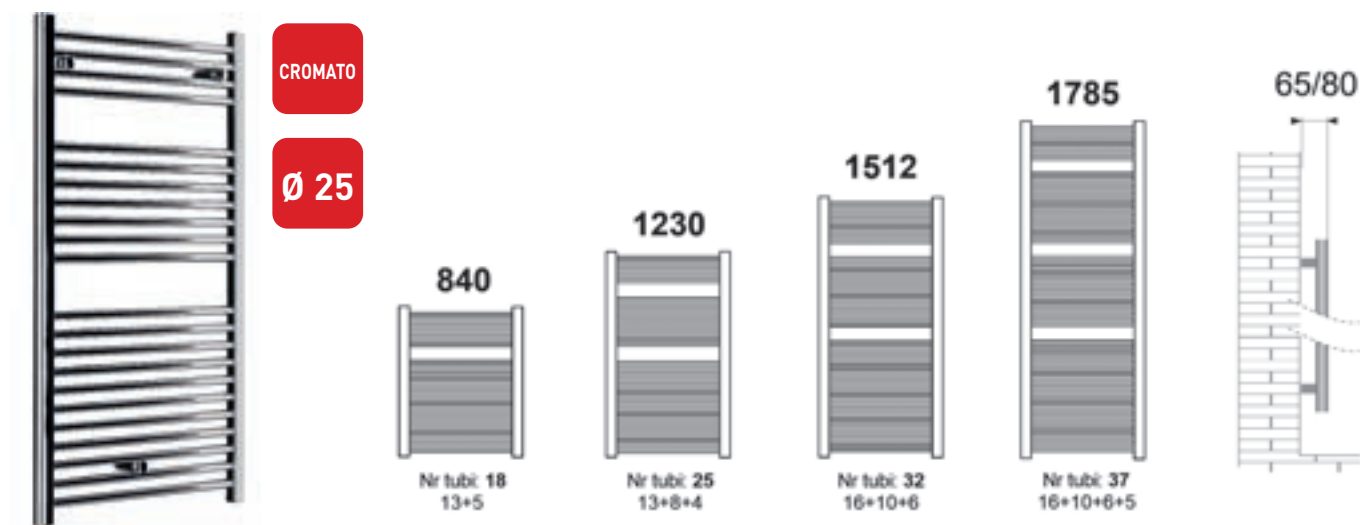

CROMATO

codice	altezza (mm)	larghezza (mm)	interasse (mm)	watt		peso (kg)	contenuto acqua (litri)	Resistenza (Watt)	UM	min. ord.	cat.	prezzo (€)
				Δt 30°C	Δt 50°C							
6111001	840	400	355	127	236	6,3	4,0	200	NR	1	15	
6111002	840	450	405	143	265	6,9	4,4	300	NR	1	15	
6111003	840	500	455	156	292	7,5	4,7	300	NR	1	15	
6111004	840	550	505	170	319	8,0	5,1	300	NR	1	15	
6111005	840	600	555	184	346	8,6	5,5	300	NR	1	15	
6111006	1230	400	355	168	321	9,0	5,6	300	NR	1	15	
6111007	1230	450	405	189	361	9,7	6,2	300	NR	1	15	
6111008	1230	500	455	210	400	10,5	6,7	300	NR	1	15	
6111009	1230	550	505	230	439	11,3	7,2	500	NR	1	15	
6111010	1230	600	555	250	479	12,1	7,8	500	NR	1	15	
6111011	1230	750	705	311	597	14,5	9,3	700	NR	1	15	
6111013	1512	450	405	233	444	12,3	7,8	500	NR	1	15	
6111014	1512	500	455	257	491	13,3	8,5	500	NR	1	15	
6111015	1512	550	505	282	539	14,3	9,1	500	NR	1	15	
6111016	1512	600	555	306	587	15,3	9,8	700	NR	1	15	
6111018	1785	400	355	251	478	13,1	8,3	500	NR	1	15	
6111019	1785	450	405	282	538	14,3	9,1	500	NR	1	15	
6111020	1785	500	455	311	593	15,4	9,9	700	NR	1	15	
6111021	1785	550	505	339	649	16,6	10,6	700	NR	1	15	
6111022	1785	600	555	368	705	17,8	11,4	700	NR	1	15	

APPENDINO SINGOLO



codice	sigla	colore	UM	min. ord. conf.	cat.	prezzo (€)
6190001	388132	Bianco	NR	1	09	
6190002	388133	Cromato	NR	1	09	

STENDINO



codice	sigla	colore - lunghezza	UM	min. ord. conf.	cat.	prezzo (€)
6190003	385023	Bianco cm.40	NR	1	09	
6190004	385024	Bianco cm.50	NR	1	09	
6190006	385026	Cromo cm.40	NR	1	09	

RACCORDO A TEE



codice	sigla	colore	UM	min. ord. conf.	cat.	prezzo (€)
6190009	386095	Bianco	NR	1	09	
6190010	386096	Cromato	NR	1	09	

RESISTENZA ELETTRICA SENZA INTERRUTTORE



codice	sigla	potenza	UM	min. ord. conf.	cat.	prezzo (€)
6191001	385987	300W	NR	1	09	
6191002	385988	500W	NR	1	09	
6191003	385989	700W	NR	1	09	
6191004	385990	1000W	NR	1	09	

RESISTENZA ELETTRICA PER TERMOSTATO



codice	sigla	potenza	UM	min. ord. conf.	cat.	prezzo (€)
6191009	385992	300W	NR	1	09	
6191010	385993	500W	NR	1	09	
6191011	385995	700W	NR	1	09	
6191012	385996	1000W	NR	1	09	

TERMOSTATO ANALOGICO



codice	sigla	colore	UM	min. ord. conf.	cat.	prezzo (€)
6191101	386005	bianco	NR	1	09	
6191102	386006	cromato	NR	1	09	

INTERRUTTORE ON-OFF



codice	sigla	colore	UM	min. ord. conf.	cat.	prezzo (€)
6191404	386007	bianco	NR	1	09	
6191405	386008	cromato	NR	1	09	

KIT DI FISSAGGIO



codice	sigla	modello - colore	UM	min. ord. conf.	cat.	prezzo (€)
6191402	388111	per Giada BC.	NR	1	09	
6191406	388112	per Giada CR.	NR	1	09	
6191407	388097	per Giulia BC.	NR	1	09	

BLISTER ATTACCHI BANDIERA



codice	sigla	colore	UM	min. ord. conf.	cat.	prezzo (€)
6191201	385977	Bianco	NR	1	09	
6191202	385978	Cromato	NR	1	09	

TANICA GLICOLE



codice	sigla	descrizione	UM	min. ord. conf.	cat.	prezzo (€)
6191403	386093	5 litri	NR	1	09	

RADIATORI IN ALLUMINIO

MODELLO SEBINO

350 - 500 - 600 - 700 - 800

IN ALLUMINIO ESTRUSO

modello	altezza (mm)	profondità (mm)	interasse (mm)	Ø attacchi
SEBINO 350	384	60	350	1/2"
SEBINO 500	534	60	500	1/2"
SEBINO 600	634	60	600	1/2"
SEBINO 700	734	60	700	1/2"
SEBINO 800	834	60	800	1/2"

Accessori a corredo:

- n. 2 mensole fino a 8 elementi
- n. 3 mensole da 10 a 14 elementi
- n. 1 tappo destro 1/2" bianco
- n. 1 valvola sfogo manuale 1/2" bianca



BIANCO
RAL
9010

serie	codice	sigla	numero elementi	lunghezza (mm)	peso a vuoto (kg)	contenuto acqua (lt)	watt Δt 30°C	watt Δt 50°C	UM	cat.	prezzo (€)
SEBINO 350	6906035	SE03501006	6	500	4,97	0,6	201	392	NR	10	
	6908035	SE03501008	8	660	6,60	0,8	268	523	NR	10	
	6910035	SE03501010	10	820	8,26	1,0	335	654	NR	10	
	6912035	SE03501012	12	980	9,93	1,2	402	785	NR	10	
	6914035	SE03501014	14	1140	11,63	1,4	469	916	NR	10	
SEBINO 500	6906050	SE05001006	6	500	6,46	1,2	265	518	NR	10	
	6908050	SE05001008	8	660	8,58	1,6	353	690	NR	10	
	6910050	SE05001010	10	820	10,70	2,0	441	863	NR	10	
	6912050	SE05001012	12	980	12,92	2,4	529	1036	NR	10	
	6914050	SE05001014	14	1140	15,14	2,7	617	1208	NR	10	
SEBINO 600	6906060	SE06001006	6	500	7,46	1,2	305	597	NR	10	
	6908060	SE06001008	8	660	9,91	1,7	406	796	NR	10	
	6910060	SE06001010	10	820	12,39	2,1	508	995	NR	10	
	6912060	SE06001012	12	980	14,92	2,5	610	1194	NR	10	
	6914060	SE06001014	14	1140	17,48	2,9	700	1393	NR	10	
SEBINO 700	6906070	SE07001006	6	500	8,45	1,3	344	674	NR	10	
	6908070	SE07001008	8	660	11,23	1,7	458	898	NR	10	
	6910070	SE07001010	10	820	14,05	2,2	573	1123	NR	10	
	6912070	SE07001012	12	980	16,91	2,6	688	1348	NR	10	
	6914070	SE07001014	14	1140	19,82	3,1	802	1572	NR	10	
SEBINO 800	6906080	SE08001006	6	500	9,45	1,4	382	748	NR	10	
	6908080	SE08001008	8	660	12,55	1,8	509	998	NR	10	
	6910080	SE08001010	10	820	15,70	2,3	636	1247	NR	10	
	6912080	SE08001012	12	980	18,91	2,7	763	1496	NR	10	
	6914080	SE08001014	14	1140	22,16	3,2	890	1746	NR	10	

900 - 1000 - 1200 - 1400 - 1600 - 1800 - 2000

IN ALLUMINIO ESTRUSO

modello	altezza (mm)	profondità (mm)	interasse (mm)	Ø attacchi
SEBINO 900	934	60	900	1/2"
SEBINO 1000	1034	60	1000	1/2"
SEBINO 1200	1234	60	1200	1/2"
SEBINO 1400	1434	60	1400	1/2"
SEBINO 1600	1634	60	1600	1/2"
SEBINO 1800	1834	60	1800	1/2"
SEBINO 2000	2034	60	2000	1/2"



Accessori a corredo:

- n. 2 mensole fino a 8 elementi
- n. 3 mensole da 10 a 14 elementi
- n. 1 tappo destro 1/2" bianco
- n. 1 valvola sfogo manuale 1/2" bianca
- n. 1 diaframma



serie	codice	sigla	numero elementi	lunghezza (mm)	peso a vuoto (kg)	contenuto acqua (lt)	watt Δt 30°C	watt Δt 50°C	UM	cat.	prezzo (€)
SEBINO 900	6906090	SE09001006	6	500	10,44	1,4	418	821	NR	10	
	6908090	SE09001008	8	660	13,87	1,9	558	1094	NR	10	
	6910090	SE09001010	10	820	17,36	2,4	697	1368	NR	10	
	6912090	SE09001012	12	980	20,90	2,9	836	1642	NR	10	
	6914090	SE09001014	14	1140	24,50	3,4	976	1915	NR	10	
SEBINO 1000	6906100	SE10001006	6	500	11,44	1,9	454	890	NR	10	
	6908100	SE10001008	8	660	15,20	2,6	605	1187	NR	10	
	6910100	SE10001010	10	820	19,01	3,2	756	1484	NR	10	
	6912100	SE10001012	12	980	22,89	3,8	907	1781	NR	10	
	6914100	SE10001014	14	1140	26,84	4,5	1058	2078	NR	10	
SEBINO 1200	6904120	SE12001004	4	340	9,09	1,4	347	684	NR	10	
	6906120	SE12001006	6	500	13,43	2,1	521	1025	NR	10	
	6908120	SE12001008	8	660	17,84	2,7	694	1367	NR	10	
	6910120	SE12001010	10	820	22,33	3,4	868	1709	NR	10	
SEBINO 1400	6904140	SE14001004	4	340	10,44	1,5	390	769	NR	10	
	6906140	SE14001006	6	500	15,42	2,2	584	1154	NR	10	
	6908140	SE14001008	8	660	20,49	2,9	779	1538	NR	10	
	6910140	SE14001010	10	820	25,64	3,6	974	1923	NR	10	
SEBINO 1600	6904160	SE16001004	4	340	11,79	1,5	429	851	NR	10	
	6906160	SE16001006	6	500	17,41	2,3	644	1277	NR	10	
	6908160	SE16001008	8	660	23,13	3,1	858	1702	NR	10	
	6910160	SE16001010	10	820	28,95	3,9	1073	2128	NR	10	
SEBINO 1800	6904180	SE18001004	4	340	13,14	1,6	466	929	NR	10	
	6906180	SE18001006	6	500	19,40	2,4	700	1394	NR	10	
	6908180	SE18001008	8	660	25,78	3,3	933	1858	NR	10	
	6910180	SE18001010	10	820	32,26	4,1	1166	2323	NR	10	
SEBINO 2000	6904200	SE20001004	4	340	14,49	1,7	502	1004	NR	10	
	6906200	SE20001006	6	500	21,39	2,6	752	1507	NR	10	
	6908200	SE20001008	8	660	28,42	3,4	1003	2009	NR	10	
	6910200	SE20001010	10	820	35,57	4,3	1254	2511	NR	10	

RADIATORI IN ALLUMINIO

MODELLO MIX

350 - 500 - 600 - 700 - 800

IN ALLUMINIO PRESSOFUSO

modello	dimensioni in mm				Ø attacchi	peso a vuoto kg circa	contenuto acqua in litri	potenza termica UNI EN 442	
	A	B	C	D				watt	
	altezza tot.	lunghezza	profondità	interasse				Δt 30°C	Δt 50°C
MIX 300	390	80	95	300	1"	1,00	0,33	43	82
MIX 350	440	80	95	350	1"	1,13	0,36	48	94
MIX 500	590	80	95	500	1"	1,61	0,40	63	123
MIX 600	690	80	95	600	1"	1,65	0,48	72	142
MIX 700	790	80	95	700	1"	2,02	0,54	82	161
MIX 800	890	80	95	800	1"	2,16	0,60	91	180



serie	codice	sigla	numero elementi	watt Δt 50°C	UM	cat.	prezzo (€)
MIX 350	6000004	MX03501001	1	94	el.	10	
	6802004	MX03501002	2	188	bat.	10	
	6803004	MX03501003	3	282	bat.	10	
	6804004	MX03501004	4	376	bat.	10	
	6805004	MX03501005	5	470	bat.	10	
	6806004	MX03501006	6	564	bat.	10	
	6807004	MX03501007	7	658	bat.	10	
	6808004	MX03501008	8	752	bat.	10	
	6809004	MX03501009	9	846	bat.	10	
	6810004	MX03501010	10	940	bat.	10	
	6811004	MX03501011	11	1.034	bat.	10	
	6812004	MX03501012	12	1.128	bat.	10	
	6813004	MX03501013	13	1.222	bat.	10	
	6814004	MX03501014	14	1.316	bat.	10	
MIX 500	6000003	MX05001001	1	123	el.	10	
	6802003	MX05001002	2	246	bat.	10	
	6803003	MX05001003	3	369	bat.	10	
	6804003	MX05001004	4	492	bat.	10	
	6805003	MX05001005	5	615	bat.	10	
	6806003	MX05001006	6	738	bat.	10	
	6807003	MX05001007	7	861	bat.	10	
	6808003	MX05001008	8	984	bat.	10	
	6809003	MX05001009	9	1.107	bat.	10	
	6810003	MX05001010	10	1.230	bat.	10	
	6811003	MX05001011	11	1.353	bat.	10	
	6812003	MX05001012	12	1.476	bat.	10	
	6813003	MX05001013	13	1.599	bat.	10	
	6814003	MX05001014	14	1.722	bat.	10	
MIX 600	6000002	MX06001001	1	142	el.	10	
	6802002	MX06001002	2	284	bat.	10	
	6803002	MX06001003	3	426	bat.	10	
	6804002	MX06001004	4	568	bat.	10	
	6805002	MX06001005	5	710	bat.	10	
	6806002	MX06001006	6	852	bat.	10	
	6807002	MX06001007	7	994	bat.	10	
	6808002	MX06001008	8	1.136	bat.	10	
	6809002	MX06001009	9	1.278	bat.	10	
	6810002	MX06001010	10	1.420	bat.	10	
	6811002	MX06001011	11	1.562	bat.	10	
	6812002	MX06001012	12	1.704	bat.	10	
	6813002	MX06001013	13	1.846	bat.	10	
	6814002	MX06001014	14	1.988	bat.	10	

serie	codice	sigla	numero elementi	watt Δt 50°C	UM	cat.	prezzo (€)
MIX 700	6000001	MX07001001	1	161	el.	10	
	6802001	MX07001002	2	322	bat.	10	
	6803001	MX07001003	3	483	bat.	10	
	6804001	MX07001004	4	644	bat.	10	
	6805001	MX07001005	5	805	bat.	10	
	6806001	MX07001006	6	966	bat.	10	
	6807001	MX07001007	7	1.127	bat.	10	
	6808001	MX07001008	8	1.288	bat.	10	
	6809001	MX07001009	9	1.449	bat.	10	
	6810001	MX07001010	10	1.610	bat.	10	
	6811001	MX07001011	11	1.771	bat.	10	
	6812001	MX07001012	12	1.932	bat.	10	
MIX 800	6000000	MX08001001	1	180	el.	10	
	6802000	MX08001002	2	360	bat.	10	
	6803000	MX08001003	3	540	bat.	10	
	6804000	MX08001004	4	720	bat.	10	
	6805000	MX08001005	5	900	bat.	10	
	6806000	MX08001006	6	1.080	bat.	10	
	6807000	MX08001007	7	1.260	bat.	10	
	6808000	MX08001008	8	1.440	bat.	10	
	6809000	MX08001009	9	1.620	bat.	10	
	6810000	MX08001010	10	1.800	bat.	10	
	6811000	MX08001011	11	1.980	bat.	10	
	6812000	MX08001012	12	2.160	bat.	10	



Nota: L'ELEMENTO SINGOLO NON E' ORDINABILE

RADIATORI IN ALLUMINIO

MODELLO VOX

350 - 500 - 600 - 700 - 800

IN ALLUMINIO PRESSOFUSO

modello	dimensioni in mm				Ø attacchi	peso a vuoto kg circa	contenuto acqua in litri	potenza termica UNI EN 442	
	A	B	C	D				watt	
	altezza tot.	lunghezza	profondità	interasse				Δt 30°C	Δt 50°C
VOX 350	440	80	95	350	1"	1,12	0,35	49	95
VOX 500	590	80	95	500	1"	1,45	0,46	65	127
VOX 600	690	80	95	600	1"	1,68	0,50	75	146
VOX 700	790	80	95	700	1"	1,95	0,53	83	164
VOX 800	890	80	95	800	1"	2,21	0,56	92	181



BIANCO
RAL
9010

serie	codice	sigla	numero elementi	watt Δt 50°C	UM	cat.	prezzo (€)
VOX 350	6000204	VX03501001	1	95	el.	10	
	6802204	VX03501002	2	190	bat.	10	
	6803204	VX03501003	3	285	bat.	10	
	6804204	VX03501004	4	380	bat.	10	
	6805204	VX03501005	5	475	bat.	10	
	6806204	VX03501006	6	570	bat.	10	
	6807204	VX03501007	7	665	bat.	10	
	6808204	VX03501008	8	760	bat.	10	
	6809204	VX03501009	9	855	bat.	10	
	6810204	VX03501010	10	950	bat.	10	
	6811204	VX03501011	11	1.045	bat.	10	
	6812204	VX03501012	12	1.140	bat.	10	
	6813204	VX03501013	13	1.235	bat.	10	
	6814204	VX03501014	14	1.330	bat.	10	
VOX 500	6000203	VX05001001	1	127	el.	10	
	6802203	VX05001002	2	254	bat.	10	
	6803203	VX05001003	3	381	bat.	10	
	6804203	VX05001004	4	508	bat.	10	
	6805203	VX05001005	5	635	bat.	10	
	6806203	VX05001006	6	762	bat.	10	
	6807203	VX05001007	7	889	bat.	10	
	6808203	VX05001008	8	1.016	bat.	10	
	6809203	VX05001009	9	1.143	bat.	10	
	6810203	VX05001010	10	1.270	bat.	10	
	6811203	VX05001011	11	1.397	bat.	10	
	6812203	VX05001012	12	1.524	bat.	10	
	6813203	VX05001013	13	1.651	bat.	10	
	6814203	VX05001014	14	1.778	bat.	10	
VOX 600	6000202	VX06001001	1	146	el.	10	
	6802202	VX06001002	2	292	bat.	10	
	6803202	VX06001003	3	438	bat.	10	
	6804202	VX06001004	4	584	bat.	10	
	6805202	VX06001005	5	730	bat.	10	
	6806202	VX06001006	6	876	bat.	10	
	6807202	VX06001007	7	1.022	bat.	10	
	6808202	VX06001008	8	1.168	bat.	10	
	6809202	VX06001009	9	1.314	bat.	10	
	6810202	VX06001010	10	1.460	bat.	10	
	6811202	VX06001011	11	1.606	bat.	10	
	6812202	VX06001012	12	1.752	bat.	10	
	6813202	VX06001013	13	1.898	bat.	10	
	6814202	VX06001014	14	2.044	bat.	10	

serie	codice	sigla	numero elementi	watt Δt 50°C	UM	cat.	prezzo (€)
VOX 700	6000201	VX07001001	1	164	el.	10	
	6802201	VX07001002	2	328	bat.	10	
	6803201	VX07001003	3	492	bat.	10	
	6804201	VX07001004	4	656	bat.	10	
	6805201	VX07001005	5	820	bat.	10	
	6806201	VX07001006	6	984	bat.	10	
	6807201	VX07001007	7	1.148	bat.	10	
	6808201	VX07001008	8	1.312	bat.	10	
	6809201	VX07001009	9	1.476	bat.	10	
	6810201	VX07001010	10	1.640	bat.	10	
	6811201	VX07001011	11	1.804	bat.	10	
	6812201	VX07001012	12	1.968	bat.	10	
VOX 800	6000200	VX08001001	1	181	el.	10	
	6802200	VX08001002	2	362	bat.	10	
	6803200	VX08001003	3	543	bat.	10	
	6804200	VX08001004	4	724	bat.	10	
	6805200	VX08001005	5	905	bat.	10	
	6806200	VX08001006	6	1.086	bat.	10	
	6807200	VX08001007	7	1.267	bat.	10	
	6808200	VX08001008	8	1.448	bat.	10	
	6809200	VX08001009	9	1.629	bat.	10	
	6810200	VX08001010	10	1.810	bat.	10	
	6811200	VX08001011	11	1.991	bat.	10	
	6812200	VX08001012	12	2.172	bat.	10	



Nota: L'ELEMENTO SINGOLO NON E' ORDINABILE

RISCALDAMENTO

RADIATORI IN ALLUMINIO

MODELLO VOX EXTRA

350 - 500 - 600 - 700 - 800

IN ALLUMINIO PRESSOFUSO

modello	dimensioni in mm				Ø attacchi	peso a vuoto kg circa	contenuto acqua in litri	potenza termica UNI EN 442 watt	
	A altezza tot.	B lunghezza	C profondità	D interasse				Δt 30°C	Δt 50°C
VOX EXTRA 350	427	80	95	350	1"	0,99	0,36	46	89
VOX EXTRA 500	577	80	95	500	1"	1,28	0,44	61	119
VOX EXTRA 600	677	80	95	600	1"	1,48	0,49	71	137
VOX EXTRA 700	777	80	95	700	1"	1,66	0,55	80	156
VOX EXTRA 800	877	80	95	800	1"	1,85	0,58	88	173

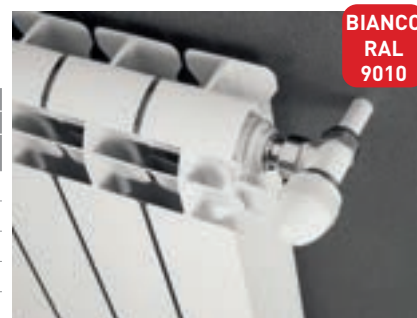

BIANCO
RAL
9010

serie	codice	sigla	numero elementi	watt Δt 50°C	UM	cat.	prezzo (€)
VOX EXTRA 350	6000214	VXE03501001	1	89	el.	10	
	6802214	VXE03501002	2	178	bat.	10	
	6803214	VXE03501003	3	267	bat.	10	
	6804214	VXE03501004	4	356	bat.	10	
	6805214	VXE03501005	5	445	bat.	10	
	6806214	VXE03501006	6	534	bat.	10	
	6807214	VXE03501007	7	623	bat.	10	
	6808214	VXE03501008	8	712	bat.	10	
	6809214	VXE03501009	9	801	bat.	10	
	6810214	VXE03501010	10	890	bat.	10	
	6811214	VXE03501011	11	979	bat.	10	
	6812214	VXE03501012	12	1.068	bat.	10	
	6813214	VXE03501013	13	1.157	bat.	10	
	6814214	VXE03501014	14	1.246	bat.	10	
VOX EXTRA 500	6000213	VXE05001001	1	119	el.	10	
	6802213	VXE05001002	2	238	bat.	10	
	6803213	VXE05001003	3	357	bat.	10	
	6804213	VXE05001004	4	476	bat.	10	
	6805213	VXE05001005	5	595	bat.	10	
	6806213	VXE05001006	6	714	bat.	10	
	6807213	VXE05001007	7	833	bat.	10	
	6808213	VXE05001008	8	952	bat.	10	
	6809213	VXE05001009	9	1.071	bat.	10	
	6810213	VXE05001010	10	1.190	bat.	10	
	6811213	VXE05001011	11	1.309	bat.	10	
	6812213	VXE05001012	12	1.428	bat.	10	
	6813213	VXE05001013	13	1.547	bat.	10	
	6814213	VXE05001014	14	1.666	bat.	10	
VOX EXTRA 600	6000212	VXE06001001	1	137	el.	10	
	6802212	VXE06001002	2	274	bat.	10	
	6803212	VXE06001003	3	411	bat.	10	
	6804212	VXE06001004	4	548	bat.	10	
	6805212	VXE06001005	5	685	bat.	10	
	6806212	VXE06001006	6	822	bat.	10	
	6807212	VXE06001007	7	959	bat.	10	
	6808212	VXE06001008	8	1.096	bat.	10	
	6809212	VXE06001009	9	1.233	bat.	10	
	6810212	VXE06001010	10	1.370	bat.	10	
	6811212	VXE06001011	11	1.507	bat.	10	
	6812212	VXE06001012	12	1.644	bat.	10	
	6813212	VXE06001013	13	1.781	bat.	10	
	6814212	VXE06001014	14	1.918	bat.	10	

serie	codice	sigla	numero elementi	watt Δt 50°C	UM	cat.	prezzo (€)
VOX EXTRA 700	6000211	VXE07001001	1	156	el.	10	
	6802211	VXE07001002	2	312	bat.	10	
	6803211	VXE07001003	3	468	bat.	10	
	6804211	VXE07001004	4	624	bat.	10	
	6805211	VXE07001005	5	780	bat.	10	
	6806211	VXE07001006	6	936	bat.	10	
	6807211	VXE07001007	7	1.092	bat.	10	
	6808211	VXE07001008	8	1.248	bat.	10	
	6809211	VXE07001009	9	1.404	bat.	10	
	6810211	VXE07001010	10	1.560	bat.	10	
	6811211	VXE07001011	11	1.716	bat.	10	
	6812211	VXE07001012	12	1.872	bat.	10	
VOX EXTRA 800	6000210	VXE08001001	1	173	el.	10	
	6802210	VXE08001002	2	346	bat.	10	
	6803210	VXE08001003	3	519	bat.	10	
	6804210	VXE08001004	4	692	bat.	10	
	6805210	VXE08001005	5	865	bat.	10	
	6806210	VXE08001006	6	1.038	bat.	10	
	6807210	VXE08001007	7	1.211	bat.	10	
	6808210	VXE08001008	8	1.384	bat.	10	
	6809210	VXE08001009	9	1.557	bat.	10	
	6810210	VXE08001010	10	1.730	bat.	10	
	6811210	VXE08001011	11	1.903	bat.	10	
	6812210	VXE08001012	12	2.076	bat.	10	



Nota: L'ELEMENTO SINGOLO NON E' ORDINABILE

350 - 500 - 600 - 700 - 800

IN ALLUMINIO PRESSOFUSO

modello	dimensioni in mm				Ø attacchi	peso a vuoto kg circa	contenuto acqua in litri	potenza termica UNI EN 442 watt	
	A altezza tot.	B lunghezza	C profondità	D interasse				Δt 30°C	Δt 50°C
VIP 350	440	80	95	350	1"	1,13	0,35	48	94
VIP 500	590	80	95	500	1"	1,62	0,39	63	123
VIP 600	690	80	95	600	1"	1,66	0,49	72	142
VIP 700	790	80	95	700	1"	2,05	0,53	82	161
VIP 800	890	80	95	800	1"	2,19	0,59	91	180



serie	codice	sigla	numero elementi	watt Δt 50°C	UM	cat.	prezzo (€)
VIP 350	6000404	VP03501001	1	94	el.	10	
	6802404	VP03501002	2	188	bat.	10	
	6803404	VP03501003	3	282	bat.	10	
	6804404	VP03501004	4	376	bat.	10	
	6805404	VP03501005	5	470	bat.	10	
	6806404	VP03501006	6	564	bat.	10	
	6807404	VP03501007	7	658	bat.	10	
	6808404	VP03501008	8	752	bat.	10	
	6809404	VP03501009	9	846	bat.	10	
	6810404	VP03501010	10	940	bat.	10	
	6811404	VP03501011	11	1.034	bat.	10	
	6812404	VP03501012	12	1.128	bat.	10	
	6813404	VP03501013	13	1.222	bat.	10	
	6814404	VP03501014	14	1.316	bat.	10	
VIP 500	6000403	VP05001001	1	123	el.	10	
	6802403	VP05001002	2	246	bat.	10	
	6803403	VP05001003	3	369	bat.	10	
	6804403	VP05001004	4	492	bat.	10	
	6805403	VP05001005	5	615	bat.	10	
	6806403	VP05001006	6	738	bat.	10	
	6807403	VP05001007	7	861	bat.	10	
	6808403	VP05001008	8	984	bat.	10	
	6809403	VP05001009	9	1.107	bat.	10	
	6810403	VP05001010	10	1.230	bat.	10	
	6811403	VP05001011	11	1.353	bat.	10	
	6812403	VP05001012	12	1.476	bat.	10	
	6813403	VP05001013	13	1.599	bat.	10	
	6814403	VP05001014	14	1.722	bat.	10	
VIP 600	6000402	VP06001001	1	142	el.	10	
	6802402	VP06001002	2	284	bat.	10	
	6803402	VP06001003	3	426	bat.	10	
	6804402	VP06001004	4	568	bat.	10	
	6805402	VP06001005	5	710	bat.	10	
	6806402	VP06001006	6	852	bat.	10	
	6807402	VP06001007	7	994	bat.	10	
	6808402	VP06001008	8	1.136	bat.	10	
	6809402	VP06001009	9	1.278	bat.	10	
	6810402	VP06001010	10	1.420	bat.	10	
	6811402	VP06001011	11	1.562	bat.	10	
	6812402	VP06001012	12	1.704	bat.	10	
	6813402	VP06001013	13	1.846	bat.	10	
	6814402	VP06001014	14	1.988	bat.	10	

serie	codice	sigla	numero elementi	watt Δt 50°C	UM	cat.	prezzo (€)
VIP 700	6000401	VP07001001	1	161	el.	10	
	6802401	VP07001002	2	322	bat.	10	
	6803401	VP07001003	3	483	bat.	10	
	6804401	VP07001004	4	644	bat.	10	
	6805401	VP07001005	5	805	bat.	10	
	6806401	VP07001006	6	966	bat.	10	
	6807401	VP07001007	7	1.127	bat.	10	
	6808401	VP07001008	8	1.288	bat.	10	
	6809401	VP07001009	9	1.449	bat.	10	
	6810401	VP07001010	10	1.610	bat.	10	
	6811401	VP07001011	11	1.771	bat.	10	
	6812401	VP07001012	12	1.932	bat.	10	
VIP 800	6000400	VP08001001	1	180	el.	10	
	6802400	VP08001002	2	360	bat.	10	
	6803400	VP08001003	3	540	bat.	10	
	6804400	VP08001004	4	720	bat.	10	
	6805400	VP08001005	5	900	bat.	10	
	6806400	VP08001006	6	1.080	bat.	10	
	6807400	VP08001007	7	1.260	bat.	10	
	6808400	VP08001008	8	1.440	bat.	10	
	6809400	VP08001009	9	1.620	bat.	10	
	6810400	VP08001010	10	1.800	bat.	10	
	6811400	VP08001011	11	1.980	bat.	10	
	6812400	VP08001012	12	2.160	bat.	10	



Nota: L'ELEMENTO SINGOLO NON E' ORDINABILE

RADIATORI IN ALLUMINIO

MODELLO KLASS

350 - 500 - 600 - 700 - 800

IN ALLUMINIO PRESSOFUSO

modello	dimensioni in mm				Ø attacchi	peso a vuoto kg circa	contenuto acqua in litri	potenza termica UNI EN 442 watt	
	A altezza tot.	B lunghezza	C profondità	D interasse				Δt 30°C	Δt 50°C
KLASS 350	432	80	80	350	1"	1,04	0,37	44	85
KLASS 500	582	80	80	500	1"	1,41	0,44	60	116
KLASS 600	682	80	80	600	1"	1,58	0,50	67	132
KLASS 700	782	80	80	700	1"	1,73	0,54	75	148
KLASS 800	882	80	80	800	1"	1,95	0,58	82	162



serie	codice	sigla	numero elementi	watt Δt 50°C	UM	cat.	prezzo (€)
KLASS 350	6000104	KL03501001	1	85	el.	10	
	6802104	KL03501002	2	170	bat.	10	
	6803104	KL03501003	3	255	bat.	10	
	6804104	KL03501004	4	340	bat.	10	
	6805104	KL03501005	5	425	bat.	10	
	6806104	KL03501006	6	510	bat.	10	
	6807104	KL03501007	7	595	bat.	10	
	6808104	KL03501008	8	680	bat.	10	
	6809104	KL03501009	9	765	bat.	10	
	6810104	KL03501010	10	850	bat.	10	
	6811104	KL03501011	11	935	bat.	10	
	6812104	KL03501012	12	1.020	bat.	10	
	6813104	KL03501013	13	1.105	bat.	10	
	6814104	KL03501014	14	1.190	bat.	10	
KLASS 500	6000103	KL05001001	1	116	el.	10	
	6802103	KL05001002	2	232	bat.	10	
	6803103	KL05001003	3	348	bat.	10	
	6804103	KL05001004	4	464	bat.	10	
	6805103	KL05001005	5	580	bat.	10	
	6806103	KL05001006	6	696	bat.	10	
	6807103	KL05001007	7	812	bat.	10	
	6808103	KL05001008	8	928	bat.	10	
	6809103	KL05001009	9	1.044	bat.	10	
	6810103	KL05001010	10	1.160	bat.	10	
	6811103	KL05001011	11	1.276	bat.	10	
	6812103	KL05001012	12	1.392	bat.	10	
	6813103	KL05001013	13	1.508	bat.	10	
	6814103	KL05001014	14	1.624	bat.	10	
KLASS 600	6000102	KL06001001	1	132	el.	10	
	6802102	KL06001002	2	264	bat.	10	
	6803102	KL06001003	3	396	bat.	10	
	6804102	KL06001004	4	528	bat.	10	
	6805102	KL06001005	5	660	bat.	10	
	6806102	KL06001006	6	792	bat.	10	
	6807102	KL06001007	7	924	bat.	10	
	6808102	KL06001008	8	1.056	bat.	10	
	6809102	KL06001009	9	1.188	bat.	10	
	6810102	KL06001010	10	1.320	bat.	10	
	6811102	KL06001011	11	1.452	bat.	10	
	6812102	KL06001012	12	1.584	bat.	10	
	6813102	KL06001013	13	1.716	bat.	10	
	6814102	KL06001014	14	1.848	bat.	10	

serie	codice	sigla	numero elementi	watt Δt 50°C	UM	cat.	prezzo (€)
KLASS 700	6000101	KL07001001	1	148	el.	10	
	6802101	KL07001002	2	296	bat.	10	
	6803101	KL07001003	3	444	bat.	10	
	6804101	KL07001004	4	592	bat.	10	
	6805101	KL07001005	5	740	bat.	10	
	6806101	KL07001006	6	888	bat.	10	
	6807101	KL07001007	7	1.036	bat.	10	
	6808101	KL07001008	8	1.184	bat.	10	
	6809101	KL07001009	9	1.332	bat.	10	
	6810101	KL07001010	10	1.480	bat.	10	
	6811101	KL07001011	11	1.628	bat.	10	
	6812101	KL07001012	12	1.776	bat.	10	
KLASS 800	6000100	KL08001001	1	162	el.	10	
	6802100	KL08001002	2	324	bat.	10	
	6803100	KL08001003	3	486	bat.	10	
	6804100	KL08001004	4	648	bat.	10	
	6805100	KL08001005	5	810	bat.	10	
	6806100	KL08001006	6	972	bat.	10	
	6807100	KL08001007	7	1.134	bat.	10	
	6808100	KL08001008	8	1.296	bat.	10	
	6809100	KL08001009	9	1.458	bat.	10	
	6810100	KL08001010	10	1.620	bat.	10	
	6811100	KL08001011	11	1.782	bat.	10	
	6812100	KL08001012	12	1.944	bat.	10	



Nota: L'ELEMENTO SINGOLO NON E' ORDINABILE

RADIATORI IN ALLUMINIO

MODELLO OSCAR

900 - 1000 - 1200 - 1400 - 1600 - 1800 - 2000

IN ALLUMINIO ESTRUSO

modello	dimensioni in mm				Ø attacchi	peso a vuoto kg circa	contenuto acqua in litri	potenza termica UNI EN 442 watt	
	A altezza tot.	B lunghezza	C profondità	D interasse				Δt 30°C	Δt 50°C
OSCAR 900	946	80	95	900	1"	1,99	0,41	88	175
OSCAR 1000	1046	80	95	1000	1"	2,05	0,42	95	190
OSCAR 1200	1246	80	95	1200	1"	2,43	0,49	109	218
OSCAR 1400	1446	80	95	1400	1"	2,80	0,56	123	245
OSCAR 1600	1646	80	95	1600	1"	3,18	0,62	136	271
OSCAR 1800	1846	80	95	1800	1"	3,53	0,69	148	297
OSCAR 2000	2046	80	95	2000	1"	3,86	0,76	161	321



serie	codice	sigla	numero elementi	watt Δt 50°C	UM	cat.	prezzo (€)
OSCAR 900	6000600	OS09001001	1	175	el.	11	
	6802600	OS09001002	2	350	bat.	11	
	6803600	OS09001003	3	525	bat.	11	
	6804600	OS09001004	4	700	bat.	11	
	6805600	OS09001005	5	875	bat.	11	
	6806600	OS09001006	6	1.050	bat.	11	
	6807600	OS09001007	7	1.225	bat.	11	
	6808600	OS09001008	8	1.400	bat.	11	
OSCAR 1000	6000601	OS10001001	1	190	el.	11	
	6802601	OS10001002	2	380	bat.	11	
	6803601	OS10001003	3	570	bat.	11	
	6804601	OS10001004	4	760	bat.	11	
	6805601	OS10001005	5	950	bat.	11	
	6806601	OS10001006	6	1.140	bat.	11	
	6807601	OS10001007	7	1.330	bat.	11	
	6808601	OS10001008	8	1.520	bat.	11	
OSCAR 1200	6000602	OS12001001	1	218	el.	11	
	6802602	OS12001002	2	436	bat.	11	
	6803602	OS12001003	3	654	bat.	11	
	6804602	OS12001004	4	872	bat.	11	
	6805602	OS12001005	5	1.090	bat.	11	
	6806602	OS12001006	6	1.308	bat.	11	
	6807602	OS12001007	7	1.526	bat.	11	
	6808602	OS12001008	8	1.744	bat.	11	
OSCAR 1400	6000603	OS14001001	1	245	el.	11	
	6802603	OS14001002	2	490	bat.	11	
	6803603	OS14001003	3	735	bat.	11	
	6804603	OS14001004	4	980	bat.	11	
	6805603	OS14001005	5	1.225	bat.	11	
	6806603	OS14001006	6	1.470	bat.	11	
	6807603	OS14001007	7	1.715	bat.	11	
	6808603	OS14001008	8	1.960	bat.	11	

serie	codice	sigla	numero elementi	watt Δt 50°C	UM	cat.	prezzo (€)
OSCAR 1600	6000604	OS16001001	1	271	el.	11	
	6802604	OS16001002	2	542	bat.	11	
	6803604	OS16001003	3	813	bat.	11	
	6804604	OS16001004	4	1.084	bat.	11	
	6805604	OS16001005	5	1.355	bat.	11	
	6806604	OS16001006	6	1.626	bat.	11	
	6807604	OS16001007	7	1.897	bat.	11	
	6808604	OS16001008	8	2.168	bat.	11	
OSCAR 1800	6000605	OS18001001	1	297	el.	11	
	6802605	OS18001002	2	594	bat.	11	
	6803605	OS18001003	3	891	bat.	11	
	6804605	OS18001004	4	1.188	bat.	11	
	6805605	OS18001005	5	1.485	bat.	11	
	6806605	OS18001006	6	1.782	bat.	11	
	6807605	OS18001007	7	2.079	bat.	11	
	6808605	OS18001008	8	2.376	bat.	11	
OSCAR 2000	6000606	OS20001001	1	321	el.	11	
	6802606	OS20001002	2	642	bat.	11	
	6803606	OS20001003	3	963	bat.	11	
	6804606	OS20001004	4	1.284	bat.	11	
	6805606	OS20001005	5	1.605	bat.	11	
	6806606	OS20001006	6	1.926	bat.	11	
	6807606	OS20001007	7	2.247	bat.	11	
	6808606	OS20001008	8	2.568	bat.	11	

Nota: L'ELEMENTO SINGOLO NON E' ORDINABILE



RISCALDAMENTO

RADIATORI IN ALLUMINIO

MODELLO OSCAR TONDO

900 - 1000 - 1200 - 1400 - 1600 - 1800 - 2000

IN ALLUMINIO ESTRUSO

modello	dimensioni in mm				Ø attacchi	peso a vuoto kg circa	contenuto acqua in litri	potenza termica UNI EN 442 watt	
	A altezza tot.	B lunghezza	C profondità	D interasse				Δt 30°C	Δt 50°C
O. TONDO 900	946	80	95	900	1"	1,99	0,41	88	175
O. TONDO 1000	1046	80	95	1000	1"	2,05	0,42	95	190
O. TONDO 1200	1246	80	95	1200	1"	2,43	0,49	109	218
O. TONDO 1400	1446	80	95	1400	1"	2,80	0,56	123	245
O. TONDO 1600	1646	80	95	1600	1"	3,18	0,62	136	271
O. TONDO 1800	1846	80	95	1800	1"	3,53	0,69	148	297
O. TONDO 2000	2046	80	95	2000	1"	3,86	0,76	161	321



BIANCO
RAL
9010

serie	codice	sigla	numero elementi	watt Δt 50°C	UM	cat.	prezzo (€)
OSCAR TONDO 900	6000610	OST09001001	1	175	el.	11	
	6802610	OST09001002	2	350	bat.	11	
	6803610	OST09001003	3	525	bat.	11	
	6804610	OST09001004	4	700	bat.	11	
	6805610	OST09001005	5	875	bat.	11	
	6806610	OST09001006	6	1.050	bat.	11	
	6807610	OST09001007	7	1.225	bat.	11	
	6808610	OST09001008	8	1.400	bat.	11	
OSCAR TONDO 1000	6000611	OST10001001	1	190	el.	11	
	6802611	OST10001002	2	380	bat.	11	
	6803611	OST10001003	3	570	bat.	11	
	6804611	OST10001004	4	760	bat.	11	
	6805611	OST10001005	5	950	bat.	11	
	6806611	OST10001006	6	1.140	bat.	11	
	6807611	OST10001007	7	1.330	bat.	11	
	6808611	OST10001008	8	1.520	bat.	11	
OSCAR TONDO 1200	6000612	OST12001001	1	218	el.	11	
	6802612	OST12001002	2	436	bat.	11	
	6803612	OST12001003	3	654	bat.	11	
	6804612	OST12001004	4	872	bat.	11	
	6805612	OST12001005	5	1.090	bat.	11	
	6806612	OST12001006	6	1.308	bat.	11	
	6807612	OST12001007	7	1.526	bat.	11	
	6808612	OST12001008	8	1.744	bat.	11	
OSCAR TONDO 1400	6000613	OST14001001	1	245	el.	11	
	6802613	OST14001002	2	490	bat.	11	
	6803613	OST14001003	3	735	bat.	11	
	6804613	OST14001004	4	980	bat.	11	
	6805613	OST14001005	5	1.225	bat.	11	
	6806613	OST14001006	6	1.470	bat.	11	
	6807613	OST14001007	7	1.715	bat.	11	
	6808613	OST14001008	8	1.960	bat.	11	

serie	codice	sigla	numero elementi	watt Δt 50°C	UM	cat.	prezzo (€)
OSCAR TONDO 1600	6000614	OST16001001	1	271	el.	11	
	6802614	OST16001002	2	542	bat.	11	
	6803614	OST16001003	3	813	bat.	11	
	6804614	OST16001004	4	1.084	bat.	11	
	6805614	OST16001005	5	1.355	bat.	11	
	6806614	OST16001006	6	1.626	bat.	11	
	6807614	OST16001007	7	1.897	bat.	11	
	6808614	OST16001008	8	2.168	bat.	11	
OSCAR TONDO 1800	6000615	OST18001001	1	297	el.	11	
	6802615	OST18001002	2	594	bat.	11	
	6803615	OST18001003	3	891	bat.	11	
	6804615	OST18001004	4	1.188	bat.	11	
	6805615	OST18001005	5	1.485	bat.	11	
	6806615	OST18001006	6	1.782	bat.	11	
	6807615	OST18001007	7	2.079	bat.	11	
	6808615	OST18001008	8	2.376	bat.	11	
OSCAR TONDO 2000	6000616	OST20001001	1	321	el.	11	
	6802616	OST20001002	2	642	bat.	11	
	6803616	OST20001003	3	963	bat.	11	
	6804616	OST20001004	4	1.284	bat.	11	
	6805616	OST20001005	5	1.605	bat.	11	
	6806616	OST20001006	6	1.926	bat.	11	
	6807616	OST20001007	7	2.247	bat.	11	
	6808616	OST20001008	8	2.568	bat.	11	



Nota: L'ELEMENTO SINGOLO NON E' ORDINABILE

Kit composto da n.2 riduzioni destre e n.2 riduzioni sinistre (con guarnizione in EPDM montata), compreso valvola sfiato d'aria manuale con anello in teflon, oppure valvola sfiato d'aria girevole con o-ring EPDM e chiavetta di chiusura.

KIT RADIATORI IN ALLUMINIO / ACCIAIO 1"



BIANCO
RAL
9010

codice	flangia Ø	Ø	valvola sfiato	UM	min. ord. conf.	cat.	prezzo (€)
● 5800011	42	1"x3/8"	manuale	NR	25	22	
● 5800012	42	1"x1/2"	manuale	NR	25	22	
● 5800001	42	1"x3/8"	girevole	NR	25	22	
● 5800002	42	1"x1/2"	girevole	NR	25	22	

KIT RADIATORI OSCAR, JUNIOR, EKOS, PLUS



BIANCO
RAL
9010

codice	flangia Ø	Ø	valvola sfiato	UM	min. ord. conf.	cat.	prezzo (€)
● 6010031	42	1"x3/8"	girevole	NR	1	25	22
● 6010033	42	1"x1/2"	girevole	NR	1	25	22

KIT RADIATORI IN GHISA



BIANCO
RAL
9010

codice	flangia Ø	Ø	valvola sfiato	UM	min. ord. conf.	cat.	prezzo (€)
● 5800031	48	1"x3/8"	manuale	NR	1	25	22
● 5800035	48	1"x1/2"	manuale	NR	1	25	22

KIT RADIATORI IN ACCIAIO 1"1/4



BIANCO
RAL
9010

codice	flangia Ø	Ø	valvola sfiato	UM	min. ord. conf.	cat.	prezzo (€)
● 5800021	56	1"1/4x3/8"	manuale	NR	15	22	
● 5800023	56	1"1/4x1/2"	manuale	NR	15	22	

TAPPI E RIDUZIONI VERNICIATI / ZINCATI

TAPPO CON GUARNIZIONE EPDM VERNICIATO RAL 9010



codice	flangia Ø	A Ø	versione	B (mm)	UM	min. ord.	conf.	cat.	prezzo (€)
● 5810301	42	1"	DX	22	NR	20	20	22	
● 5810302	42	1"	SX	22	NR	20	20	22	
● 5810305	56	1"1/4	DX	24	NR	5	25	22	
● 5810306	56	1"1/4	SX	24	NR	5	25	22	

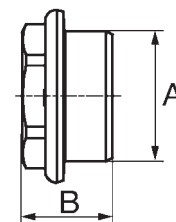

ACCESSORI RADIATORI

TAPPI E RIDUZIONI VERNICIATI / ZINCATI

RIDUZIONE CON GUARNIZIONE EPDM VERNICIATA RAL 9010



codice	flangia Ø	A Ø	C Ø	versione	B (mm)	UM	min. ord.	conf.	cat.	prezzo (€)
● 5810001	42	1"	1/4"	DX	22	NR	20	20	22	
● 5810002	42	1"	1/4"	SX	22	NR	20	20	22	
● 5810003	42	1"	3/8"	DX	22	NR	20	20	22	
● 5810004	42	1"	3/8"	SX	22	NR	20	20	22	
● 5810005	42	1"	1/2"	DX	22	NR	20	20	22	
● 5810006	42	1"	1/2"	SX	22	NR	20	20	22	
● 5810007	42	1"	3/4"	DX	22	NR	20	20	22	
● 5810008	42	1"	3/4"	SX	22	NR	20	20	22	
● 5810017	56	1"1/4	1/4"	DX	24	NR	5	25	22	
● 5810018	56	1"1/4	1/4"	SX	24	NR	5	25	22	
● 5810019	56	1"1/4	3/8"	DX	24	NR	5	25	22	
● 5810020	56	1"1/4	3/8"	SX	24	NR	5	25	22	
● 5810021	56	1"1/4	1/2"	DX	24	NR	5	25	22	
● 5810022	56	1"1/4	1/2"	SX	24	NR	5	25	22	

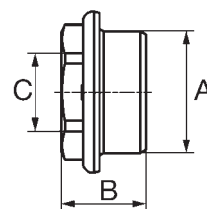

TAPPO ZINCATO



codice	flangia Ø	A Ø	versione	B (mm)	UM	min. ord.	conf.	cat.	prezzo (€)
● 5810601	48	1"	DX	22	NR	1	100	22	
● 5810602	48	1"	SX	22	NR	1	100	22	
● 5810603	56	1"1/4	DX	24	NR	1	50	22	
● 5810604	56	1"1/4	SX	24	NR	1	50	22	

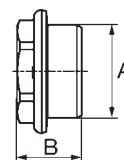

RIDUZIONE ZINCATATA



codice	flangia Ø	A Ø	C Ø	versione	B (mm)	UM	min. ord.	conf.	cat.	prezzo (€)
● 5810100	48	1"	1/4"	DX	22	NR	1	100	22	
● 5810101	48	1"	1/4"	SX	22	NR	1	100	22	
● 5810102	48	1"	3/8"	DX	22	NR	1	100	22	
● 5810103	48	1"	3/8"	SX	22	NR	1	100	22	
● 5810104	48	1"	1/2"	DX	22	NR	1	100	22	
● 5810105	48	1"	1/2"	SX	22	NR	1	100	22	
● 5810108	56	1"1/4	1/4"	DX	24	NR	1	50	22	
● 5810109	56	1"1/4	1/4"	SX	24	NR	1	50	22	
● 5810110	56	1"1/4	3/8"	DX	24	NR	1	50	22	
● 5810111	56	1"1/4	3/8"	SX	24	NR	1	50	22	
● 5810112	56	1"1/4	1/2"	DX	24	NR	1	50	22	
● 5810113	56	1"1/4	1/2"	SX	24	NR	1	50	22	
● 5810114	56	1"1/4	3/4"	DX	24	NR	1	50	22	
● 5810115	56	1"1/4	3/4"	SX	24	NR	1	50	22	
● 5810116	56	1"1/4	1"	DX	24	NR	1	50	22	
● 5810117	56	1"1/4	1"	SX	24	NR	1	50	22	

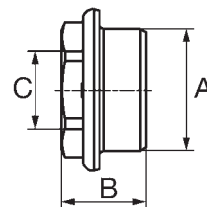

ACCESSORI RADIATORI

CHIAVE PER TAPPI E RIDUZIONI VERNICIATE

In nylon per radiatori Oscar.



NOVITÀ!

codice	sigla	Ø	UM	min. ord.	conf.	cat.	prezzo (€)
● 6010015	A019CHITP	28	NR	1	5	20	

CHIAVE PER TAPPI E RIDUZIONI VERNICIATE

In nylon



codice	Ø	UM	min. ord.	conf.	cat.	prezzo (€)
● 5800061	32-42-48-56	NR	1	50	20	

NIPPLE DX-SX IN ACCIAIO



codice	finitura	Ø	lungh. (mm)	UM	min. ord.	conf.	cat.	prezzo (€)
● 5800033	nero	1"	25,5	NR	1	100	20	
● 5800034	nero	1"1/4	27,5	NR	1	100	20	
● 5800037	zincato	1"	25,5	NR	1	100	20	
● 5800038	zincato	1"1/4	27,5	NR	1	100	20	
● 6010019	x Oscar e Ekos plus	1"	30	NR	1	50	20	

GUARNIZIONE PER TAPPI E RIDUZIONI - ESENTE AMIANTO

Composta da fibre di cellulosa e cariche minerali.



codice	flangia Ø	Ø	spessore (mm)	UM	min. ord. conf.	cat.	prezzo (€)
● 5810401	42	1"	1	NR	100	20	
● 5810404	56	1"1/4	2	NR	100	20	

GUARNIZIONE PER NIPPLE

Guarnizione bianca per tenuta elementi in alluminio.



codice	flangia Ø	Ø	spessore (mm)	UM	min. ord. conf.	cat.	prezzo (€)
● 6010007	42	1"	1	NR	100	20	

GUARNIZIONE IN CARTONCINO

In pura cellulosa riciclabile 100%, per tenuta elementi radiatori.



codice	flangia Ø	Ø	spessore (mm)	UM	min. ord. conf.	cat.	prezzo (€)
● 5810501	42	1"	0,5	NR	200	20	
● 5810502	48	1"	0,5	NR	200	20	
● 5810503	56	1"1/4	0,5	NR	200	20	

GUARNIZIONE IN GOMMA

In gomma EPDM bianca, per tappi e riduzioni flangiati con incavo.



codice	flangia Ø	Ø	spessore (mm)	UM	min. ord. conf.	cat.	prezzo (€)
● 5810550	42	1"	2,5	NR	100	20	

GUARNIZIONE OR PER OSCAR, JUNIOR, EKOS PLUS

In gomma per tenuta elementi e per tappi, riduzioni solo per serie Oscar, Junior, Ekosplus.

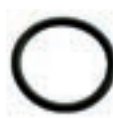

codice	flangia Ø	Ø	spessore (mm)	UM	min. ord. conf.	cat.	prezzo (€)
● 6010020	42	1"	3,2	NR	10	20	

VALVOLA SFIATO MANUALE

In ottone con guarnizione in teflon.



codice	Ø	UM	min. ord.	conf.	cat.	prezzo (€)
● 5800050	1/4"	NR	1	100	20	
● 5800051	3/8"	NR	1	100	20	

VALVOLA SFIATO GIREVOLE

In ottone D. 1/2" con guarnizione o-ring in EPDM, apertura con chiave in nylon.



codice	descrizione	UM	min. ord.	conf.	cat.	prezzo (€)
● 5800040	valvola	NR	1	100	20	
● 5800060	chiave	NR	1	100	20	

DIAFRAMMA PER OSCAR



codice	sigla	misura	UM	min. ord. conf.	cat.	prezzo (€)
● 6010018	A022DIA0SEK	Ø 1"x75	NR	1	20	

BOMBOLETTA SPRAY VERNICE BIANCO RAL9010



codice	sigla	volume	UM	min. ord.	conf.	cat.	prezzo (€)
● 6010009	A010SPY10	ml. 200	NR	1	12	20	

ACCESSORI RADIATORI

MENSOLE VERNICIATE

MENSOLA RADIATORI ALLUMINIO RAL 9010

Il prezzo è riferito alla coppia

versione piatta



versione tonda

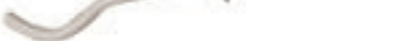

codice	versione	dimens. (mm)	tassello (mm)	UM	min. ord.	conf.	cat.	prezzo (€)
● 5860001	piatta	7x170	10	CP	50	50	20	
● 5860002	tonda	7x170	10	CP	1	50	20	
● 5860003	tonda	9x170	12	CP	50	50	20	
● 5860004	tonda	9x190	12	CP	1	50	20	

MENSOLA RADIATORI GHISA RAL 9010

Il prezzo è riferito alla coppia



codice	colonne nr.	dimens. (mm)	tassello (mm)	UM	min. ord.	conf.	cat.	prezzo (€)
● 5862001	2-3	12x200	16	CP	1	25	20	
● 5862002	3-4	12x230	16	CP	1	25	20	
● 5862003	5-6	12x260	16	CP	1	25	20	

MENSOLA RADIATORI ACCIAIO RAL 9010

Il prezzo è riferito alla coppia



codice	colonne nr.	dimens. (mm)	tassello (mm)	mozzo (mm)	UM	min. ord.	conf.	cat.	prezzo (€)
● 5861002	3-4	8,5x220	12	53	CP	1	25	20	
● 5861003	5-6	11,5x270	16	53	CP	1	25	20	
● 5861004	2-3	9x190	12	63	CP	1	40	20	
● 5861005	3-4	9x230	12	63	CP	1	30	20	
● 5861006	5-6	12x265	16	63	CP	1	25	20	

MENSOLA A PAVIMENTO PER RADIATORI RAL 9010

Il prezzo è riferito alla coppia.
Possibile abbinamento con copri piedino (5863502)



codice	colonne nr.	mozzo (mm)	UM	min. ord. conf.	cat.	prezzo (€)
● 5863501	2-6	45-60	CP	1	20	

ROSETTE

ROSONE PP APRIBILE PER RADIATORI



codice	tubo Ø	Ø (mm)	UM	min. ord. conf.	cat.	prezzo (€)
● 2661021	8-16	60	NR	100	23	

BORCHIA COPRIFORO APRIBILE PER TUBO RAME



codice	tubo Ø	Ø (mm)	UM	min. ord. conf.	cat.	prezzo (€)
● 2750635	8-16	60	NR	100	23	

ROSETTA APRIBILE PER VALVOLE MONOTUBO



codice	tubo Ø	dimensioni (mm)	UM	min. ord. conf.	cat.	prezzo (€)
● 2750630	14-16	90x50	NR	50	23	

CIRCOLATORE PER RISCALDAMENTO E CONDIZIONAMENTO

Circolatore domestico elettronico per riscaldamento e condizionamento, dotato di protezione da funzionamento a secco, cuscinetti in carbonio con assenza totale di piombo secondo le normative. Modalità estiva per prevenire il blocco del motore dopo lunghi periodi di inattività. Incluso guscio isolante in un pezzo unico.

Modalità di funzionamento 3 curve a pressione proporzionale (per riscaldamento a radiatori)
3 curve a pressione costante (per riscaldamento a pavimento)
3 curve a velocità fissa (per boiler e ventilazione)

Caratteristiche Temperatura min. -10°C, max +110°C
H. max 8 mt
Q. max 4 mc/h

Fluidi consentiti acqua, fluidi puliti e liberi da particelle solide, glicole max 40%.



CURVE DI LAVORO

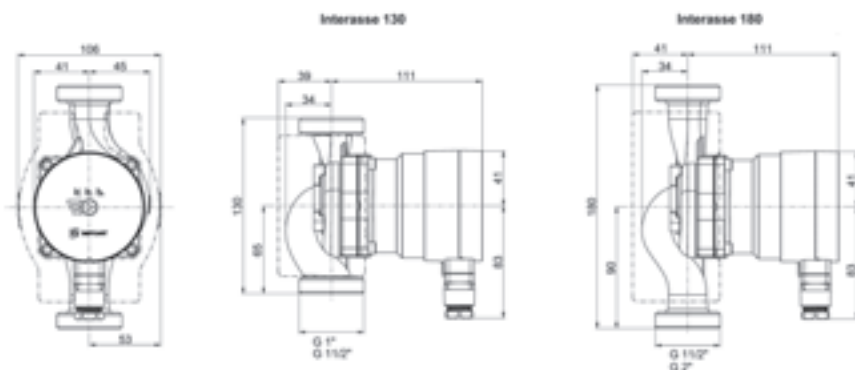
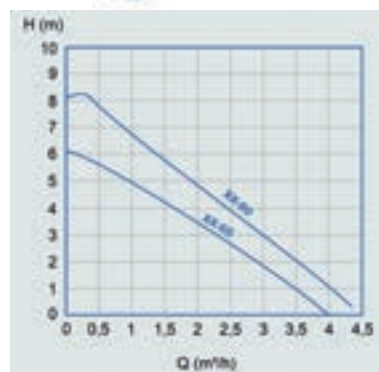

	codice	Modello	Interasse (mm)	Attacchi	UM	min. ord.	conf.	cat.	prezzo (€)
●	5901001	15-60	130	1"	NR	1	30	03	
●	5901002	25-60	130	1"1/2	NR	1	30	03	
●	5901011	25-60	180	1"1/2	NR	1	30	03	
●	5901005	25-80	130	1"1/2	NR	1	30	03	
●	5901014	25-80	180	1"1/2	NR	1	30	03	
●	5901013	32-60	180	2"	NR	1	30	03	
●	5901012	32-80	180	2"	NR	1	30	03	

CIRCOLATORE PER ACQUA CALDA SANITARIA

Circolatore domestico elettronico per acqua calda sanitaria, corpo pompa in acciaio inox, cuscinetti in carbonio con assenza totale di piombo secondo le normative. Tecnologia motore a magneti permanenti ed elettronica con inverter per un risparmio energetico. Un tasto solo per selezionare le modalità di funzionamento.

Modalità di funzionamento 3 curve a pressione proporzionale
3 curve a pressione costante
3 curve a velocità fissa

Caratteristiche Temperatura min. -10°C, max +110°C
H. max 8 mt
Q. max 4 mc/h

Fluidi consentiti acqua, fluidi puliti e liberi da particelle solide, senza oli minerali



CURVE DI LAVORO

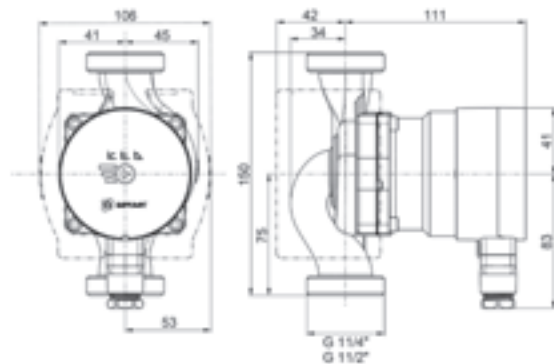
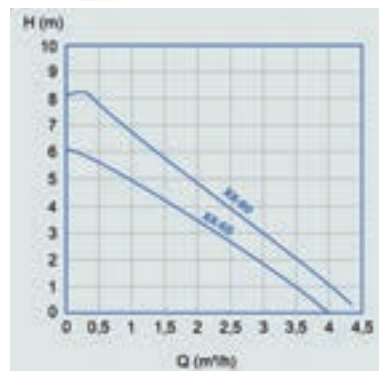

	codice	Modello	Interasse (mm)	Attacchi	UM	min. ord.	conf.	cat.	prezzo (€)
●	5901022	20-60	150	1"1/4	NR	1	16	03	
●	5901020	25-60	150	1"1/2	NR	1	16	03	

ACCESSORI SOTTOCALDAIA

POMPE SCARICO CONDENZA

POMPA A PISTONE PER CALDAIA A CONDENSAZIONE



Pompa a pistone per lo smaltimento delle acque acide di condensa di caldaie a gas murali e a terra fino a 50kw. I componenti resistono all'acidità della condensa pertanto non necessita di sali o di neutralizzatore di condensa.

A corredo: dispositivo antisfonaggio per evitare che la pompa lavori a secco; cavo di alimentazione da 1,5mt con connettore e blocco di sicurezza; 5mt di tubo di scarico condensa (6x9) con adattatore multidiametro per il collegamento in ingresso sulla pompa; kit di installazione.

Applicazioni: caldaia

Capacità di scarico verticale: 4 metri (portata 4,5 lt/h)



codice	sigla	Nr. entrate	Portata max	Livello sonoro	Serbatoio UM	min. ord.	conf.	cat.	prezzo (€)
● 3351021	SI61CE01UN23	1	10 lt/h	<28dB(A)	370 ml	NR	1	5	03

SANICONDENS DECO+



Pompa compatta per lo smaltimento delle acque di condensa di caldaie murali a gas fino a 25kw. A corredo: viti di fissaggio, protezione termica calibrata con riarmo automatico.

Applicazioni: caldaia

Capacità di scarico: 6 metri in verticale (tubo Ø 8/10 mm.)
60 metri in orizzontale (tubo Ø 8/10 mm.)

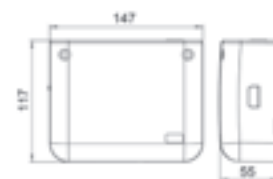

codice	sigla	Nr. entrate	Portata max	Livello sonoro	Serbatoio UM	min. ord.	conf.	cat.	prezzo (€)
● 3350021	SCONDECO+	1	15 lt/h	<25dB(A)	175 ml	NR	1	12	13

POMPA CENTRIFUGA PER CALDAIA A CONDENSAZIONE



Pompa per lo smaltimento delle acque di condensa di caldaie a gas, climatizzatori e vetrine refrigerate.

A corredo: viti di fissaggio, valvola antiritorno integrata, cavo d'alimentazione da 2 mt.

Applicazioni: caldaia - climatizzatore - vetrina refrigerata - evaporatore

Capacità di scarico: 4,5 metri in verticale
30 metri orizzontale

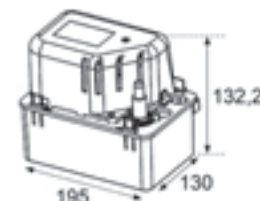

codice	sigla	Nr. entrate	Portata max	Livello sonoro	Serbatoio UM	min. ord.	conf.	cat.	prezzo (€)
● 3351024	SI1805SIUN23	2	500 lt/h	<47 dB(A)	0,5 lt	NR	1	03	

SANICONDENS BEST FLAT



Pompa con neutralizzatore incorporato, per preservare i tubi dagli attacchi delle acque acide di condensa, di caldaie a gas (fino a 80kw) e a gasolio (fino a 50kw) sia murali che a terra, deumidificatori e apparecchi refrigeranti.

A corredo: viti di fissaggio, valvola clapet, cavo di alimentazione da 1,5 mt., cavo allarme a 2 fili da 1,5 mt., tubo flessibile di scarico 5 mt, una confezione di granuli Sanisal (3350610).

Applicazioni: caldaia - deumidificatore - banchi frigo

Capacità di scarico: 4,5 metri in verticale (tubo Ø int. 10 mm.)
50 metri orizzontale (tubo Ø int. 10 mm.)

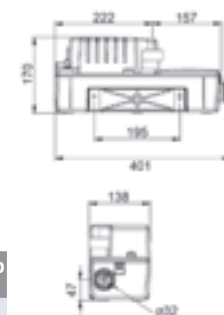

codice	sigla	Nr. entrate	Portata max	Livello sonoro	Serbatoio UM	min. ord.	conf.	cat.	prezzo (€)
● 3350028	SCONBFLAT	3	360 lt/h	<45 dB(A)	3,5 lt	NR	1	13	

SANICONDENS PRO



Pompa con serbatoio di grande capacità per lo smaltimento delle acque di condensa di caldaie a gas murali e terra fino a 50kw.

A corredo: viti di fissaggio, valvola clapet, cavo d'alimentazione da 1,5 mt., cavo di allarme pre-connesso, tubo di scarico in gomma da 5 mt.

Applicazioni: caldaia - climatizzatore - deumidificatore - climatizzatore a soffitto - banchi refrigeranti

Capacità di scarico: 4,5 metri in verticale (tubo Ø 8/10 mm.)
50 metri in orizzontale (tubo Ø 8/10 mm.)

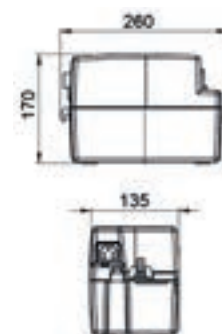

codice	sigla	Nr. entrate	Portata max	Livello sonoro	Serbatoio UM	min. ord.	conf.	cat.	prezzo (€)
● 3350024	SCONPRO21	2	372 lt/h	<45 dB(A)	2,2 lt	NR	1	13	

SANINEUTRAL MINI



Neutralizzatore di condensa per caldaie murali fino a 25kw., ingombro ridotto. Possibile collegamento superiore o laterale. Diametro 32 mm. A corredo: supporti di fissaggio, una confezione di granuli Sanisal (3350610).

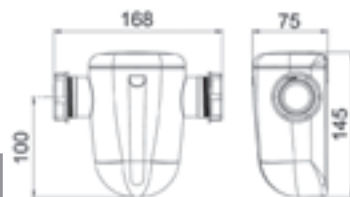

codice	sigla	pH min.	filtro	UM	min. ord. conf.	cat.	prezzo (€)
● 3350011	NEUTRALMINISTD	2,5	grani	NR	1	13	

SANINEUTRAL



Neutralizzatore di condensa per caldaie a gas (fino a 50 kw) e a gasolio (fino a 35 kw) sia murali che a terra. Diametro di scarico 40 mm. Può essere installato con Sanicondens Mini (3350022) e Sanicondens Pro (3350024). A corredo: supporti di fissaggio, una confezione di granuli Sanisal (3350610).

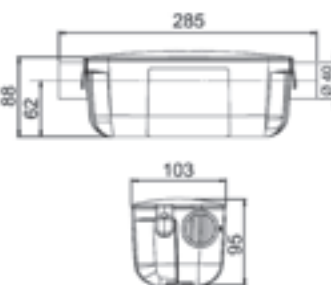

codice	sigla	pH min.	filtro	UM	min. ord. conf.	cat.	prezzo (€)
● 3350010	SANINEUT	2,5	grani	NR	1	13	

NEUTRA SLIM



Neutralizzatore di condensa per caldaie murali fino a 35kw, con capacità di scambio da pH acido a pH neutro. Installazione sia verticale che orizzontale, dotata di by-pass che impedisce il ritorno in caldaia della condensa trattata. E' necessario sostituire la cartuccia periodicamente

codice	descrizione	UM	min. ord.	conf.	cat.	prezzo (€)
● 2006014	neutralizzatore	NR	1	12	04	
● 2006015	cartuccia	NR	1	12	04	

NEUTRA CONDENS



Neutralizzatore di condensa per caldaie murali fino a 35kw. Installazione sia verticale che orizzontale. E' necessario sostituire periodicamente i granuli all'interno del filtro.

A corredo: kit fissaggio, coppia di raccordi portagomma in PP da 3/4"(DN16)

codice	descrizione	UM	min. ord. conf.	cat.	prezzo (€)
● 2006018	neutralizzatore	NR	1	22	

RICARICA NEUTRA CONDENS



Granuli di carbonato di calcio che permettono di neutralizzare l'acidità delle acque di condensa delle caldaie. Per Neutra Condens (2006018)

codice	contenuto (gr)	UM	min. ord. conf.	cat.	prezzo (€)
● 2006019	300	NR	1	04	

SANISAL GRANULI DI NEUTRALIZZAZIONE



Granuli di sale che permettono di neutralizzare l'acidità delle acque di condensa delle caldaie. Da sostituire circa una volta all'anno. Per Sanicondens Deco+ (3350021), Sanicondens Best (3350025), Sanineutral Mini (3350011), Sanineutral (33500100).

codice	sigla	descrizione	UM	min. ord. conf.	cat.	prezzo (€)
● 3350610	SANISALBT	bottiglia da 1,2kg	NR	1	15	10

ACCESSORI SOTTOCALDAIA

DOSATORI

DOSATORE POLIFOSFATI CON GHIERA

Con by-pass e attacchi con ghiera.
Compreso chiave e una ricarica.

Dosaggio proporzionale 2/4 ppm x mc
Portata 1,5 mc/h
Pressione d'esercizio 2-6 bar
Temperatura massima 45°C
Perdita di carico 0,2 bar
Autonomia ricarica 12-15 mc



codice	attacchi	UM	min. ord. conf.	cat.	prezzo (€)
● 2007010	F/F 1/2"	NR	12	03	

DOSATORE POLIFOSFATI CON DIMA

Con by-pass e DIMA, attacchi con ghiera.
Compreso chiave e una ricarica.

Dosaggio proporzionale 2/4 ppm x mc
Portata 1,5 mc/h
Pressione d'esercizio 2-6 bar
Temperatura massima 45°C
Perdita di carico 0,2 bar
Autonomia ricarica 12-15 mc



codice	attacchi	UM	min. ord. conf.	cat.	prezzo (€)
● 2007011	F/F 1/2"	NR	12	03	

POMPA DOSATRICE ATTACCO RUOTABILE

Totalmente meccanica (no corrente/no batterie) a dosaggio proporzionale del liquido anticalcare. Attacchi ruotabili a 360° con codoli in ottone.

Serbatoio con attacco a baionetta per una rapida ricarica senza dover chiudere l'acqua dell'impianto.

Compresa prima carica da 300 cl.

Installazione su tubi sia orizzontali che verticali



codice	attacchi	UM	min. ord. conf.	cat.	prezzo (€)
● 2007020	F/F 1/2"	NR	1	12	03

POMPA DOSATRICE ATTACCO RUOTABILE CON DIMA

Totalmente meccanica (no corrente/no batterie) a dosaggio proporzionale del liquido anticalcare. Attacchi ruotabili a 360° con codoli in ottone.

Serbatoio con attacco a baionetta per una rapida ricarica senza dover chiudere l'acqua dell'impianto.

Compresa prima carica da 300 cl.

Installazione solo su tubi orizzontali



codice	attacchi	UM	min. ord. conf.	cat.	prezzo (€)
● 2007021	F/F 1/2"	NR	1	12	03

DOSATORE POLIFOSFATI FISSO

Ideale per grandi tubazioni. Con by-pass.
Compreso chiave e una ricarica.

Dosaggio proporzionale 2/4 ppm x mc
Portata 5,8 mc/h
Pressione d'esercizio 2-10bar
Temperatura massima 45°C
Perdita di carico 0,2 bar
Autonomia ricarica 40 mc



codice	attacchi	UM	min. ord. conf.	cat.	prezzo (€)
● 2007019	3/4" F - 1" F	NR	1	6	03

RICARICA POLIFOSFATI PER 2007019

NOVITÀ!



codice	descrizione	UM	min. ord. conf.	cat.	prezzo (€)
● 2007023	confez. 4 capsule	NR	1	12	09

RICARICA POLIFOSFATI IN POLVERE



codice	descrizione	UM	min. ord. conf.	cat.	prezzo (€)
● 2007012	confez. 6 capsule	NR	12	120	09
● 2007013	barattolo da 1 kg	NR	1	120	09

RICARICA POLIFOSFATI LIQUIDO

Soluzione equilibrata di sali alimentari specifici per il trattamento dell'acqua potabile.

Previene le incrostazioni e la corrosione negli impianti sanitari domestici (mantiene puliti ed efficienti gli scambiatori di calore, le tubazioni, le rubinetterie).

Conforme alla normativa CE per uso alimentare.

Specifico per pompe dosatrici.

Dosaggio: 15-30 gr./mc

Temperatura massima acqua: 75°C

Durezza massima acqua: 35°F



codice	descrizione	UM	min. ord. conf.	cat.	prezzo (€)
● 2007022	bottiglia da 1 litro	NR	1	18	05

DEFANGATORE MAGNETICO E CICLONICO

Filtro ciclonico in tecnopolimero (materiale usato per prodotti ad alta resistenza).

Coefficiente di portata KVS: 10 m³/h . Questo implica che il defangatore Delò ha una minore perdita di carico; il circolatore d'acqua assorbe meno energia elettrica.

Il canale di entrata è separato dal canale di uscita: questo obbliga l'acqua in entrata a passare per il filtro ciclonico del defangatore, quindi l'acqua in uscita è tutta filtrata.

Nelle caldaie di ultima generazione, gli scambiatori hanno passaggi ridotti rispetto al passato, sono più soggetti ad intasarsi con acqua parzialmente filtrata; maggior durata dello scambiatore.

Magnete: è in samario-cobalto con flusso di campo magnetico pari a 20.000 gauss.

Il samario-cobalto mantiene le caratteristiche magnetiche a temperature superiori i 250°C.

Il vantaggio di questi magneti è la loro naturale resistenza alla corrosione.

Non c'è bisogno della valvola a sfera. Per fare la pulizia basta togliere il magnete dalla sua sede.

Lo sporco di origine ferritica precipita nel pozzetto sottostante; è sufficiente aprire lo scarico (anche a circuito funzionante) ed il defangatore è pulito.

Si reinserisce il magnete nell'opportuna sede ed il defangatore è di nuovo funzionante.

DATI TECNICI:	Pressione max di esercizio: 3 bar
	Temperatura di esercizio: 0 ÷ 90° C
	Kvs: 10,1 m ³ /h
	Campo magnetico: 2 x 1 T (= 2x10000 GAUSS)



codice	∅	UM	min. ord. conf.	cat.	prezzo (€)
● 2007051	3/4"	NR	1	06	

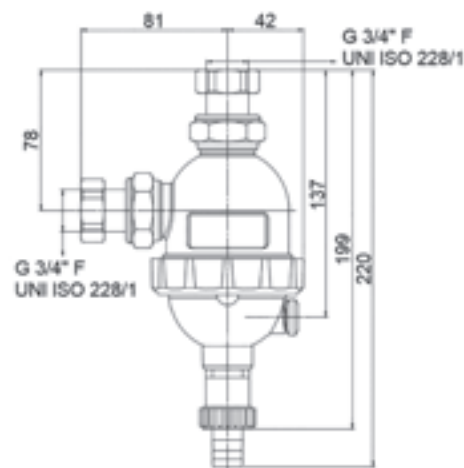

ACCESSORI SOTTOCALDAIA

DEFANGATORI

DEFANGATORE TF1 TOTAL FILTER



Filtro idro-ciclonico magnetico per rimuovere fanghi e contaminanti magnetici e non, in circuiti termici.

Grado di filtrazione: 0,7 µm. Capacità di contenimento di 400 gr. di fanghi senza perdita di carico.

Può essere installato su tubazioni sia verticali che orizzontali.

A corredo: 2 valvole, una confezione di Filter Fluid+Protector da 500 ml. (2009009).

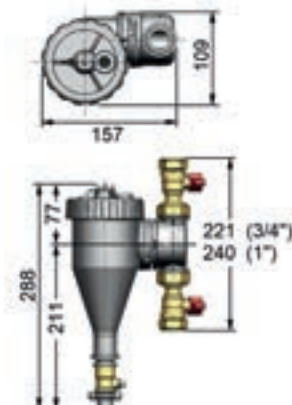

	codice	sigla	Ø	UM	min. ord. conf.	cat.	prezzo (€)
●	2009203	59256	3/4"	NR	1	11	
●	2009204	52257	1"	NR	1	11	

DEFANGATORE TF1 COMPACT



Filtro idro-ciclonico magnetico (versione compatta) per rimuovere fanghi e contaminanti magnetici e non, in circuiti termici.

Grado di filtrazione: 0,7 µm. Capacità di contenimento di 300 gr. di fanghi senza perdita di carico.

Può essere installato su tubazioni sia verticali che orizzontali.

A corredo: 2 valvole, una confezione di Filter Fluid+Protector da 500 ml. (2009009)

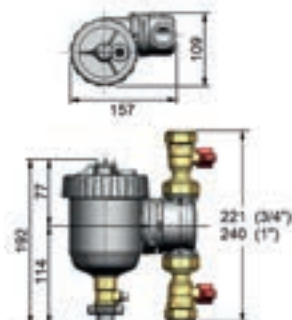

	codice	sigla	Ø	UM	min. ord. conf.	cat.	prezzo (€)
●	2009201	62131	3/4"	NR	1	11	
●	2009202	62132	1"	NR	1	11	

FILTER FLUID + PROTECTOR ml.500



Abbinato ad un defangatore magnetico, protegge l'impianto dalla corrosione e dalle incrostazioni. Miscela di disperdenti che porta in sospensione le impurità convogliandole nel filtro.

E' possibile quindi lasciarlo all'interno dell'impianto senza effettuare il risciacquo.

	codice	sigla	UM	min. ord. conf.	cat.	prezzo (€)	
●	2009009	62235	NR	1	10	05	

JRGURED RIDUTTORE DI PRESSIONE PN25

Il corpo in bronzo offre una maggiore precisione e stabilità nel tempo in quanto meno soggetto a corrosioni. Corsore cilindrico e sede in acciaio inossidabile, membrana e guarnizione della valvola in EPDM, attacco per il manometro da ambedue le parti. Riduttore rinomato per la sua precisione a valle, grazie ai tre cilindri che permettono un movimento equilibrato in tutte le situazioni. Filtro in acciaio inox a maglia larga 1000 µm, tazza del filtro in bronzo. In posizione orizzontale permette una rapida pulizia senza intervenire sul meccanismo. Completo di raccordi in ottone.

Installabile in qualsiasi posizione.

Temperatura: max. 70°C

Regolazione di fabbrica: 400 kPa (4 bar)

Pressione secondaria: 200 - 600 kPa (2 - 6 bar)

Pressione nominale: 2500 kPa (25 bar)

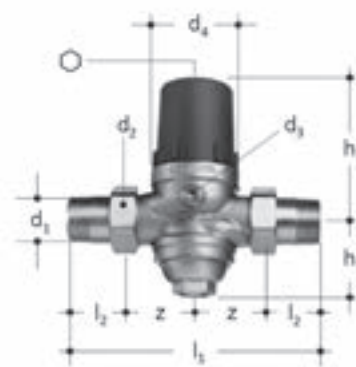

GN	DN	d1 R	d2 G	d3 Rp	d4	h1	h2	l1	l2	z	⬡
(")	(mm)	(")	(")	(")	(mm)	(mm)	(mm)	(mm)	(mm)	(mm)	
½	15	½	¾	⅝	52	29	79	130	25	40	5
¾	20	¾	1	⅝	58	36	86	142	29	43	5
1	25	1	1¼	¾	70	52	110	167	34	50	6
1¼	32	1¼	1½	¾	77	64	121	196	38	60	6
1½	40	1½	1¾	¾	94	80	157	222	39	73	8

codice	∅	DN	attacco manometro	UM	min. ord. conf.	cat.	prezzo (€)
● 2900000	1/2"	15	1/8"	NR	1	13	
● 2900001	3/4"	20	1/8"	NR	1	17	
● 2900002	1"	25	1/4"	NR	1	17	
● 2900003	1"1/4	32	1/4"	NR	1	17	
● 2900004	1"1/2	40	1/4"	NR	1	17	

MANOMETRI E TERMOMETRI

MANOMETRI

MANOMETRO ATTACCO RADIALE



INFORMAZIONI TECNICHE

Cassa	ABS
Vetro	Plastica (Lustran)
Quadrante	ABS
Classe	1,6
Elemento	Molle lega rame
Temperatura esercizio	-20° / +80°C
Conforme	UNI EN 837-1

codice	∅	scala (bar)	attacco	UM	min. ord. conf.	cat.	prezzo (€)
1001004	50	0÷4	1/4"	NR	1	09	
1001005	50	0÷6	1/4"	NR	1	09	
1001006	50	0÷10	1/4"	NR	1	09	
1002004	63	0÷4	1/4"	NR	1	09	
1002005	63	0÷6	1/4"	NR	1	09	
1002006	63	0÷10	1/4"	NR	1	09	
1002007	63	0÷16	1/4"	NR	1	09	
1002008	63	0÷25	1/4"	NR	1	09	
1003005	80	0÷6	3/8"	NR	1	09	
1003006	80	0÷10	3/8"	NR	1	09	
1004003	100	0÷6	1/2"	NR	1	09	
1004004	100	0÷10	1/2"	NR	1	09	

MANOMETRO ATTACCO POSTERIORE



INFORMAZIONI TECNICHE

Cassa	ABS
Vetro	Plastica (Lustran)
Quadrante	ABS
Classe	1,6
Elemento	Molle lega rame
Temperatura esercizio	-20° / +80°C
Conforme	UNI EN 837-1

codice	∅	scala (bar)	attacco	UM	min. ord. conf.	cat.	prezzo (€)
1011007	50	0÷6	1/8"	NR	1	09	
1011008	50	0÷10	1/8"	NR	1	09	
1011003	50	0÷6	1/4"	NR	1	09	
1011004	50	0÷10	1/4"	NR	1	09	
1012002	63	0÷4	1/4"	NR	1	09	
1012003	63	0÷6	1/4"	NR	1	09	
1012004	63	0÷10	1/4"	NR	1	09	
1012005	63	0÷16	1/4"	NR	1	09	

MANOMETRO PER GAS BASSA PRESSIONE OMOLOGATO INAIL



INFORMAZIONI TECNICHE

Cassa	Acciaio nichelato
Vetro	Plastica (Lustran)
Quadrante	Alluminio
Classe	1,6
Elemento	Polmone (soffietto)
Temperatura esercizio	-20° / +80°C
Conforme	UNI EN 837-1

codice	∅	scala (Mbar)	attacco	UM	min. ord. conf.	cat.	prezzo (€)
1021001	63	0÷60	1/4"	NR	1	09	
1021002	63	0÷100	1/4"	NR	1	09	
1021004	63	0÷250	1/4"	NR	1	09	
1021006	63	0÷600	1/4"	NR	1	09	

MANOMETRO IN BAGNO DI GLICERINA ATTACCO RADIALE



INFORMAZIONI TECNICHE

Cassa	Acciaio inox
Vetro	Plastica (Lustran)
Quadrante	ABS
Classe	1,6
Elemento	Molle lega rame
Temperatura esercizio	-20° / +80°C
Conforme	UNI EN 837-1

codice	∅	scala (bar)	attacco	UM	min. ord. conf.	cat.	prezzo (€)
1031009	63	0÷6	1/4"	NR	1	09	
1031010	63	0÷10	1/4"	NR	1	09	
1031011	63	0÷16	1/4"	NR	1	09	
1031012	63	0÷25	1/4"	NR	1	09	

TERMOMANOMETRO



INFORMAZIONI TECNICHE

Cassa	ABS
Vetro	Plastica (Lustran)
Quadrante	ABS
Classe	1,6
Elemento	Molle lega rame
Temperatura esercizio	-20° / +80°C
Conforme	UNI EN 837-1

codice	∅	scala (bar)	scala (°C)	attacco	UM	min. ord. conf.	cat.	prezzo (€)
1041002	80	0÷6	0÷120	Radiale	NR	1	09	
1041003	80	0÷6	0÷120	Posteriore	NR	1	09	

TERMOMETRO A CONTATTO



INFORMAZIONI TECNICHE

Cassa	Acciaio
Vetro	Plexiglas
Quadrante	Alluminio
Classe	±2°C
Elemento	Spirale bimetallica
Temperatura esercizio	-20° / +80°C
Conforme	UNI EN 13190

TERMOMETRO AD IMMERSIONE ATTACCO RADIALE



INFORMAZIONI TECNICHE

Cassa	Acciaio
Vetro	Plexiglas
Quadrante	Alluminio
Classe	±2°C
Pozzetto in ottone	Compreso
Elemento	Spirale bimetallica
Temperatura esercizio	-20° / +80°C
Conforme	UNI EN 13190

codice	∅	scala (°C)	attacco	UM	min. ord. conf.	cat.	prezzo (€)
● 1121001	63	0÷120	Con molla	NR	1	03	

codice	∅	scala (°C)	gambo (cm)	UM	min. ord. conf.	cat.	prezzo (€)
● 1101003	80	0÷120	5	NR	1	03	
● 1101103	80	0÷120	10	NR	1	03	

TERMOMETRO AD IMMERSIONE ATTACCO POSTERIORE



INFORMAZIONI TECNICHE

Cassa	Acciaio
Vetro	Plexiglas
Quadrante	Alluminio
Classe	±2°C
Pozzetto in ottone	Compreso
Elemento	Spirale bimetallica
Temperatura esercizio	-20° / +80°C
Conforme	UNI EN 13190

codice	∅	scala (°C)	gambo (cm)	UM	min. ord. conf.	cat.	prezzo (€)
● 1111003	63	0÷120	5 cm.	NR	1	03	
● 1111103	63	0÷120	10 cm.	NR	1	03	
● 1112003	80	0÷120	5 cm.	NR	1	03	
● 1112103	80	0÷120	10 cm.	NR	1	03	
● 1112001	80	-30/+50	5 cm.	NR	1	03	
● 1112101	80	-30/+50	10 cm.	NR	1	03	

ACCESSORI MANOMETRI E TERMOMETRI

RUBINETTO PORTAMANOMETRO A 3 VIE CON FLANGIA

PN10

Conforme norme INAIL



codice	∅	UM	min. ord. conf.	cat.	prezzo (€)
● 1201001	1/4"	NR	1	09	
● 1201002	3/8"	NR	1	09	
● 1201003	1/2"	NR	1	09	

RUBINETTO PORTAMANOMETRO A PULSANTE

PN10



codice	∅	UM	min. ord. conf.	cat.	prezzo (€)
● 1202002	3/8"	NR	1	10	09

SERPENTINA PORTAMANOMETRO M/F

PN16

Girevole in rame nichelato



codice	∅	UM	min. ord. conf.	cat.	prezzo (€)
● 1203001	1/4"	NR	1	09	
● 1203002	3/8"	NR	1	09	
● 1203003	1/2"	NR	1	09	

POZZETTO TERMOMETRICO IN OTTONE



codice	∅	gambo (cm)	UM	min. ord. conf.	cat.	prezzo (€)
● 1204001	1/2"	5	NR	1	09	
● 1204002	1/2"	10	NR	1	09	

CATALOGO
LISTINO N° 6

IMPIANTISTICA

MULTISTRATO	252
RACCORDERIA IN OTTONE	260
RACCORDERIA IN RAME-BRONZO	277
RACCORDERIA PER TUBO POLIETILENE	291
GIUNTI ESTENSIBILI ED ANTIVIBRANTI GAS E ACQUA	297
TUBO SOLARE	302
ISOLAMENTO IN GOMMA	304
ISOLAMENTO IN POLIETILENE	306



MULTISTRATO

TUBO MULTISTRATO GAS

Sistema di tubi multistrato PE-X/Al/PE-X per adduzione di gas combustibile secondo normativa UNI 11344, omologato per metano e GPL (installazione secondo UNI 7129:2015). Il tubo multistrato è composto da 5 strati: uno strato interno realizzato in polietilene reticolato PE-Xb, uno di collante, uno strato di alluminio, un altro di collante e uno strato esterno realizzato ancora in polietilene reticolato PE-Xb di colore giallo.

Sistema di raccordi in ottone a pressione con 2 OR di tenuta idraulica in mescola HNBR.

Utilizzabili con diversi profili di pinzatura:

Profilo ganascia	Ø 16	Ø 20	Ø 26	Ø 32
TH	X	X	X	X
H	X	X	X	X
U	X	X		X



TUBO MULTISTRATO NUDO IN ROTOLI COLORE GIALLO



codice	sigla	d _e x e (mm)	UM	rotolo min.ord.	conf. mt x pallet	cat.	prezzo (€)
4890201	2402001620100	16x2	MT	100	1100	05	
4890202	2402002020100	20x2	MT	100	800	05	
4890203	2402002630050	26x3	MT	50	400	05	
4890204	2402003230050	32x3	MT	50	300	05	

LEGENDA

d_e = diametro esterno

e = spessore tubo

S-iso = spessore isolamento

dg = diametro guaina

TUBO MULTISTRATO IN ROTOLI IN GUAINA CORRUGATA GIALLA



codice	sigla	d _e x e (mm)	dg (mm)	UM	rotolo min.ord.	conf. mt x pallet	cat.	prezzo (€)
4890401	2522051620050	16x2	25,0	MT	50	800	05	
4890402	2522052020050	20x2	28,8	MT	50	750	05	
4890403	2522052630050	26x3	36,0	MT	50	500	05	

RACCORDI IN OTTONE A PRESSARE PER MULTISTRATO GAS

MANICOTTO



codice	sigla	Ø	UM	min. ord.	conf.	cat.	prezzo (€)
4853001	4101160000001	16	NR	5	40	03	
4853002	4101200000001	20	NR	5	40	03	
4853003	4101260000001	26	NR	5	20	03	

MANICOTTO DI RIDUZIONE



codice	sigla	Ø	UM	min. ord.	conf.	cat.	prezzo (€)
4853101	4102201600001	20x16	NR	5	40	03	
4853102	4102261600001	26x16	NR	5	30	03	
4853103	4102262000001	26x20	NR	5	20	03	

RACCORDO MASCHIO



codice	sigla	Ø	UM	min. ord.	conf.	cat.	prezzo (€)
4853201	4103160002001	16x1/2"	NR	5	40	03	
4853202	4103160003001	16x3/4"	NR	5	30	03	
4853203	4103200002001	20x1/2"	NR	5	40	03	
4853204	4103200003001	20x3/4"	NR	5	30	03	
4853206	4103260003001	26x3/4"	NR	5	30	03	
4853208	4103320004001	32x1"	NR	5	20	03	

RACCORDO FEMMINA



codice	sigla	Ø	UM	min. ord.	conf.	cat.	prezzo (€)
4853301	4104160002001	16x1/2"	NR	5	40	03	
4853302	4104160003001	16x3/4"	NR	5	30	03	
4853303	4104200002001	20x1/2"	NR	5	40	03	
4853304	4104200003001	20x3/4"	NR	5	30	03	
4853306	4104260003001	26x3/4"	NR	5	20	03	
4853307	4104260004001	26x1"	NR	5	15	03	
4853308	4104320004001	32x1"	NR	5	15	03	

RACCORDI IN OTTONE A PRESSARE PER MULTISTRATO GAS

RACCORDO DIRITTO FEMMINA CON DADO GIREVOLE



codice	sigla	Ø	UM	min. ord.	conf.	cat.	prezzo (€)
4854101	4114160003001	16x3/4"	NR	5	30	03	
4854102	4114200003001	20x3/4"	NR	5	30	03	
4854103	4114260003001	26x3/4"	NR	5	30	03	

GOMITO A 90° CON DERIVAZIONE MASCHIO



codice	sigla	Ø	UM	min. ord.	conf.	cat.	prezzo (€)
4853701	4108160002001	16x1/2"	NR	5	40	03	
4853702	4108200002001	20x1/2"	NR	5	30	03	
4853703	4108200003001	20x3/4"	NR	5	20	03	
4853704	4108260003001	26x3/4"	NR	5	20	03	

GOMITO A 90° CON DERIVAZIONE FEMMINA



codice	sigla	Ø	UM	min. ord.	conf.	cat.	prezzo (€)
4853801	4109160002001	16x1/2"	NR	5	30	03	
4853802	4109200002001	20x1/2"	NR	5	30	03	
4853803	4109200003001	20x3/4"	NR	5	25	03	
4853805	4109260003001	26x3/4"	NR	5	20	03	

GOMITO A 90°



codice	sigla	Ø	UM	min. ord.	conf.	cat.	prezzo (€)
4853501	4106160000001	16	NR	5	30	03	
4853502	4106200000001	20	NR	5	30	03	
4853503	4106260000001	26	NR	5	15	03	

RACCORDO MURALE A GOMITO



codice	sigla	Ø	UM	min. ord.	conf.	cat.	prezzo (€)
4854201	4134160002001	16x1/2"	NR	5	15	03	
4854202	4134200002001	20x1/2"	NR	5	15	03	

TEE A 90°



codice	sigla	Ø	UM	min. ord.	conf.	cat.	prezzo (€)
4853401	4105160000001	16	NR	2	20	03	
4853402	4105200000001	20	NR	2	16	03	

TEE A 90° CON DERIVAZIONE MASCHIO



codice	sigla	Ø	UM	min. ord.	conf.	cat.	prezzo (€)
4853901	4110160002001	16x1/2"x16	NR	2	20	03	
4853902	4110200002001	20x1/2"x20	NR	2	16	03	

TEE A 90° CON DERIVAZIONE FEMMINA



codice	sigla	Ø	UM	min. ord.	conf.	cat.	prezzo (€)
4853601	4107160002001	16x1/2"x16	NR	2	20	03	
4853602	4107200002001	20x1/2"x20	NR	2	16	03	
4853605	4107260003001	26x3/4"x26	NR	2	10	03	

TEE A 90° RIDOTTO



codice	sigla	Ø	UM	min. ord.	conf.	cat.	prezzo (€)
4854001	4113162016001	16x20x16	NR	2	16	03	
4854002	4113201616001	20x16x16	NR	2	16	03	
4854003	4113201620001	20x16x20	NR	2	16	03	
4854004	4113202016001	20x20x16	NR	2	16	03	
4854010	4113262026001	26x20x26	NR	2	12	03	

MULTISTRATO

TUBO MULTISTRATO ACQUA

Sistema di tubi multistrato PE-X/Al/PE-X per la distribuzione di acqua calda e fredda ad uso sanitario, per gli impianti di riscaldamento a basse ed alte temperature, per gli impianti di raffrescamento e antigelo.

Il tubo multistrato è composto da 5 strati: uno strato interno realizzato in polietilene reticolato PE-Xb, uno di adesivo, uno strato di alluminio Stark, un altro di adesivo e uno strato esterno realizzato ancora in polietilene reticolato PE-Xb. Temperatura massima 95°C, pressione massima 10 bar.

Sistema di raccordi in ottone a pressare con 2 OR di tenuta idraulica in EPDM perossidico.

Utilizzabili con diversi profili di pinzatura:

Profilo ganascia	Ø 16	Ø 20	Ø 26	Ø 32	Ø 40	Ø 50	Ø 63
TH	X	X	X	X	X	X	X
H	X	X	X	X	X		
U	X	X		X	X	X	X



TUBO MULTISTRATO NUDO IN ROTOLI

Per uso sanitario e riscaldamento.



codice	sigla	d _e x e (mm)	UM	rotolo min.ord.	conf. mt x pallet	cat.	prezzo (€)
4890001	2400001420100	14x2	MT	100	1100	05	
4890002	2400001620100	16x2	MT	100	1100	05	
4890003	2400001620200	16x2	MT	200	1200	05	
4890004	2400001620500	16x2	MT	500	1000	05	
4890006	2400002020100	20x2	MT	100	800	05	
4890007	2400002630050	26x3	MT	50	400	05	
4890008	2400003230050	32x3	MT	50	300	05	

TUBO MULTISTRATO NUDO IN BARRE

Per uso sanitario e riscaldamento.



codice	sigla	d _e x e (mm)	UM	barra (mt)	fascio min.ord.	cat.	prezzo (€)
4890101	2400001620005	16x2	MT	5	125	05	
4890102	2400002020005	20x2	MT	5	75	05	
4890103	2400002630005	26x3	MT	5	45	05	
4890104	2400003230005	32x3	MT	5	30	05	
4890105	2400004035004	40x3,5	MT	4	36	05	
4890106	2400005040004	50x4	MT	4	28	05	
4890107	2400006345004	63x4,5	MT	4	16	05	

TUBO MULTISTRATO PREISOLATO IN ROTOLI COLORE AZZURRO

Per uso sanitario e riscaldamento.
Spessore isolamento conforme alla legge 10/91 ad esclusione dell'articolo 4891009.



codice	sigla	d _e x e (mm)	S-iso (mm)	UM	rotolo min.ord.	conf. mt x pallet	cat.	prezzo (€)
4891001	2550001420050	14x2	6	MT	50	700	05	
4891002	2550001620050	16x2	6	MT	50	750	05	
4891003	2550001620100	16x2	6	MT	100	1100	05	
4891009	2550022020050	20x2	6	MT	50	700	05	
4891005	2550002020050	20x2	10	MT	50	500	05	
4891006	2550002630025	26x3	10	MT	25	300	05	
4891007	2550002630050	26x3	10	MT	50	450	05	
4891008	2550003230025	32x3	10	MT	25	250	05	

TUBO MULTISTRATO PREISOLATO IN ROTOLI COLORE ROSSO

Per uso sanitario e riscaldamento.
Spessore isolamento conforme alla legge 10/91 ad esclusione dell'articolo 4892007.



codice	sigla	d _e x e (mm)	S-iso (mm)	UM	rotolo min.ord.	conf. mt x pallet	cat.	prezzo (€)
4892001	2560001420050	14x2	6	MT	50	700	05	
4892002	2560001620050	16x2	6	MT	50	750	05	
4892008	2560001620100	16x2	6	MT	100	1100	05	
4892007	2560042020050	20x2	6	MT	50	700	05	
4892003	2560002020050	20x2	10	MT	50	500	05	
4892005	2560002630025	26x2	10	MT	25	300	05	
4892006	2560002630050	26x3	10	MT	50	450	05	
4892009	2560003230025	32x3	10	MT	25	250	05	

TUBO MULTISTRATO PREISOLATO IN ROTOLI COLORE VERDE

Per condizionamento e refrigerazione.
Spessore isolamento conforme alla legge 10/91.



codice	sigla	d _e x e (mm)	S-iso (mm)	UM	rotolo min.ord.	conf. mt x pallet	cat.	prezzo (€)
4893001	2580011620050	16x2	10	MT	50	500	05	
4893003	2580012020050	20x2	13	MT	50	400	05	
4893004	2580012630025	26x3	13	MT	25	250	05	
4893005	2580013230025	32x3	13	MT	25	250	05	

LEGENDA

d_e = diametro esterno

e = spessore tubo

S-iso = spessore isolamento

RACCORDI IN OTTONE A PRESSARE PER MULTISTRATO ACQUA

MANICOTTO



codice	sigla	Ø	UM	min. ord.	conf.	cat.	prezzo (€)
4894001	4001160000001	16	NR	5	40	05	
4894002	4001200000001	20	NR	5	40	05	
4894003	4001260000001	26	NR	5	20	05	
4894004	4001320000001	32	NR	5	15	05	
4894005	4001400000001	40	NR	1	8	05	
4894006	4001500000001	50	NR	1	4	05	
4894007	4001630000001	63	NR	1	12	05	

MANICOTTO DI RIDUZIONE



codice	sigla	Ø	UM	min. ord.	conf.	cat.	prezzo (€)
4894101	4002201600001	20x16	NR	5	40	05	
4894102	4002261600001	26x16	NR	5	30	05	
4894103	4002262000001	26x20	NR	5	30	05	
4894104	4002322000001	32x20	NR	5	20	05	
4894105	4002322600001	32x26	NR	5	15	05	
4894108	4002402600001	40x26	NR	1	10	05	
4894109	4002403200001	40x32	NR	1	10	05	
4894106	4002503200001	50x32	NR	1	6	05	
4894107	4002504000001	50x40	NR	1	4	05	
4894110	4002634000001	63x40	NR	1	12	05	
4894111	4002635000001	63x50	NR	1	1	05	

RACCORDO MASCHIO



codice	sigla	Ø	UM	min. ord.	conf.	cat.	prezzo (€)
4894202	4003160002001	16x1/2"	NR	5	40	05	
4894203	4003200002001	20x1/2"	NR	5	40	05	
4894204	4003200003001	20x3/4"	NR	5	35	05	
4894205	4003260003001	26x3/4"	NR	5	30	05	
4894206	4003260004001	26x1"	NR	5	20	05	
4894207	4003320004001	32x1"	NR	5	20	05	
4894208	4003400005001	40x1"1/4	NR	1	12	05	
4894209	4003500006001	50x1"1/2	NR	1	8	05	
4894210	4003630007001	63x2"	NR	1	16	05	

RACCORDO FEMMINA



codice	sigla	Ø	UM	min. ord.	conf.	cat.	prezzo (€)
4894301	4004160002001	16x1/2"	NR	5	40	05	
4894302	4004200002001	20x1/2"	NR	5	40	05	
4894303	4004200003001	20x3/4"	NR	5	30	05	
4894304	4004260003001	26x3/4"	NR	5	30	05	
4894305	4004260004001	26x1"	NR	5	15	05	
4894306	4004320004001	32x1"	NR	5	15	05	
4894307	4004400005001	40x1"1/4	NR	1	10	05	
4894308	4004500006001	50x1"1/2	NR	1	8	05	

GOMITO A 90°



codice	sigla	Ø	UM	min. ord.	conf.	cat.	prezzo (€)
4894501	4006160000001	16	NR	5	30	05	
4894502	4006200000001	20	NR	5	30	05	
4894503	4006260000001	26	NR	5	15	05	
4894504	4006320000001	32	NR	5	10	05	
4894505	4006400000001	40	NR	1	6	05	
4894506	4006500000001	50	NR	1	2	05	
4894507	4006630000001	63	NR	1	8	05	

GOMITO A 90° CON DERIVAZIONE FEMMINA



codice	sigla	Ø	UM	min. ord.	conf.	cat.	prezzo (€)
4894801	4009160002001	16x1/2"	NR	5	30	05	
4894802	4009200002001	20x1/2"	NR	5	30	05	
4894803	4009200003001	20x3/4"	NR	5	25	05	
4894804	4009260003001	26x3/4"	NR	5	20	05	
4894805	4009320004001	32x1"	NR	5	10	05	
4894806	4009400005001	40x1"1/4	NR	1	6	05	
4894807	4009500006001	50x1"1/2	NR	1	3	05	

MULTISTRATO

RACCORDI IN OTTONE A PRESSARE PER MULTISTRATO ACQUA

GOMITO A 90° CON DERIVAZIONE MASCHIO



codice	sigla	Ø	UM	min. ord.	conf.	cat.	prezzo (€)
4894701	4008160002001	16x1/2"	NR	5	40	05	
4894702	4008200002001	20x1/2"	NR	5	30	05	
4894703	4008200003001	20x3/4"	NR	5	25	05	
4894704	4008260003001	26x3/4"	NR	5	20	05	
4894705	4008320004001	32x1"	NR	5	10	05	
4894706	4008400005001	40x1"1/4	NR	1	8	05	
4894707	4008500006001	50x1"1/2	NR	1	4	05	
4894708	4008630007001	63x2"	NR	1	10	05	

GOMITO A 45°



codice	sigla	Ø	UM	min. ord.	conf.	cat.	prezzo (€)
4897001	4011260000001	26	NR	1	1	05	
4897002	4011320000001	32	NR	1	1	05	
4897003	4011400000001	40	NR	1	1	05	

TEE A 90°



codice	sigla	Ø	UM	min. ord.	conf.	cat.	prezzo (€)
4894401	4005160000001	16	NR	2	20	05	
4894402	4005200000001	20	NR	2	16	05	
4894403	4005260000001	26	NR	2	10	05	
4894404	4005320000001	32	NR	2	8	05	
4894405	4005400000001	40	NR	1	4	05	
4894406	4005500000001	50	NR	1	7	05	
4894407	4005630000001	63	NR	1	4	05	

TEE A 90° RIDOTTO



codice	sigla	Ø	UM	min. ord.	conf.	cat.	prezzo (€)
4895001	4013201616001	20x16x16	NR	2	16	05	
4895002	4013201620001	20x16x20	NR	2	16	05	
4895003	4013202016001	20x20x16	NR	2	16	05	
4895018	4013261620001	26x16x20	NR	2	12	05	
4895004	4013261626001	26x16x26	NR	2	12	05	
4895005	4013262020001	26x20x20	NR	2	12	05	
4895006	4013262026001	26x20x26	NR	2	12	05	
4895019	4013262616001	26x26x16	NR	2	12	05	
4895020	4013262620001	26x26x20	NR	2	12	05	
4895007	4013322032001	32x20x32	NR	2	8	05	
4895008	4013322626001	32x26x26	NR	2	8	05	
4895009	4013322632001	32x26x32	NR	2	8	05	
4895012	4013402640001	40x26x40	NR	1	4	05	
4895013	4013403232001	40x32x32	NR	1	5	05	
4895014	4013403240001	40x32x40	NR	1	4	05	
4895015	4013502650001	50x26x50	NR	1	8	05	
4895016	4013503250001	50x32x50	NR	1	8	05	
4895017	4013504050001	50x40x50	NR	1	8	05	
4895021	4013633263001	63x32x63	NR	1	1	05	
4895022	4013634063001	63x40x63	NR	1	1	05	
4895023	4013635063001	63x50x63	NR	1	4	05	

TEE A 90° CON DERIVAZIONE FEMMINA



codice	sigla	Ø	UM	min. ord.	conf.	cat.	prezzo (€)
4894601	4007160002001	16x1/2"x16	NR	2	20	05	
4894602	4007200002001	20x1/2"x20	NR	2	16	05	
4894603	4007200003001	20x3/4"x20	NR	2	16	05	
4894604	4007260003001	26x3/4"x26	NR	2	10	05	
4894605	4007320004001	32x1"x32	NR	2	8	05	
4894606	4007400005001	40x1"1/4x40	NR	1	12	05	
4894607	4007500006001	50x1"1/2x50	NR	1	12	05	
4894608	4007630005001	63x1"1/4x63	NR	1	8	05	

TEE A 90° CON DERIVAZIONE MAGGIORATA



codice	sigla	Ø	UM	min. ord.	conf.	cat.	prezzo (€)
4897101	4029162016001	16x20x16	NR	2	16	05	
4897102	4029202620001	20x26x20	NR	2	12	05	

RACCORDI IN OTTONE A PRESSARE PER MULTISTRATO ACQUA

RACCORDO MURALE A GOMITO



codice	sigla	∅	h (mm)	UM	min. ord.	conf.	cat.	prezzo (€)
4895400	4034160102001	16x1/2"	36	NR	5	15	05	
4895401	4034160002001	16x1/2"	53	NR	5	15	05	
4895404	4034200102001	20x1/2"	36	NR	5	15	05	
4895402	4034200002001	20x1/2"	53	NR	5	15	05	

RACCORDO DIRITTO FEMMINA CON DADO GIREVOLE



codice	sigla	∅	UM	min. ord.	conf.	cat.	prezzo (€)
4895101	4014160002001	16x1/2"	NR	1	40	05	
4895103	4014200002001	20x1/2"	NR	1	40	05	
4895104	4014200003001	20x3/4"	NR	1	40	05	
4895105	4014260003001	26x3/4"	NR	1	30	05	

RUBINETTO CON ROSONE



codice	sigla	∅	UM	min. ord.	conf.	cat.	prezzo (€)
4895301	4016161600001	16	NR	1	6	05	
4895302	4016202000001	20	NR	1	6	05	

COLLETTORI E DIME

RACCORDO CON CALOTTA PER TUBO MULTISTRATO



codice	sigla	∅	UM	min. ord.	conf.	cat.	prezzo (€)
4895801	4097162002001	16x2"x1/2"	NR	1	50	05	

COLLETORE CON VALVOLE DI REGOLAZIONE 2 DERIVAZIONI



codice	sigla	∅	UM	min. ord.	conf.	cat.	prezzo (€)
4896401	4098020203001	3/4"x1/2"	NR	8	05	05	

COLLETORE CON VALVOLE DI REGOLAZIONE 3 DERIVAZIONI



codice	sigla	∅	UM	min. ord.	conf.	cat.	prezzo (€)
4898501	4098030203001	3/4"x1/2"	NR	6	05	05	

COLLETORE CON VALVOLE DI REGOLAZIONE 4 DERIVAZIONI



codice	sigla	∅	UM	min. ord.	conf.	cat.	prezzo (€)
4898601	4098040203001	3/4"x1/2"	NR	4	05	05	

DIMA DI FISSAGGIO



codice	sigla	descrizione	UM	min. ord.	conf.	cat.	prezzo (€)
4895601	4017000000001	semplice	NR	1	05	05	
4895701	4018000000001	angolata multipla	NR	1	05	05	

MULTISTRATO

RACCORDI A COMPRESSIONE PER MULTISTRATO ACQUA

Conforme alle norme UNI EN 1254-3, UNI EN 21003-3

Raccordo in ottone CW617N-DW con filettatura realizzata secondo la norma UNI EN 10226-1, O-ring in EPDM nero conformi alla norma UNI EN 681-1, idoneo per il trasporto di acque destinate al consumo umano (potabili).

Per impianti di riscaldamento, circuito sanitario, aria compressa, acqua refrigerata.

Per tubi multistrato dalle seguenti caratteristiche:

Ø (mm)	spessore (mm)
16	2
20	2
26	3
32	3



MANICOTTO F/F



codice	sigla	Ø	UM	min. ord. conf.	cat.	prezzo (€)
6550001	C301 016000000	16	NR	10	10	
6550002	C301 020000000	20	NR	10	10	
6550003	C301 026000000	26	NR	5	10	
6550004	C301 032000000	32	NR	5	10	

MANICOTTO F/FILETTO F



codice	sigla	Ø	UM	min. ord. conf.	cat.	prezzo (€)
6552008	C303 016004000	16x1/2"	NR	10	10	
6552010	C303 020004000	20x1/2"	NR	10	10	
6552011	C303 020006000	20x3/4"	NR	10	10	
6552012	C303 026006000	26x3/4"	NR	5	10	
6552013	C303 026008000	26x1"	NR	5	10	
6552014	C303 032008000	32x1"	NR	5	10	

MANICOTTO F/FILETTO M



codice	sigla	Ø	UM	min. ord. conf.	cat.	prezzo (€)
6552001	C302 016004000	16x1/2"	NR	10	10	
6552003	C302 020004000	20x1/2"	NR	10	10	
6552004	C302 020006000	20x3/4"	NR	10	10	
6552005	C302 026006000	26x3/4"	NR	5	10	
6552006	C302 026008000	26x1"	NR	5	10	
6552007	C302 032008000	32x1"	NR	5	10	

GOMITO A 90° F/FILETTO M



codice	sigla	Ø	UM	min. ord. conf.	cat.	prezzo (€)
6554001	C402 016004000	16x1/2"	NR	10	10	
6554003	C402 020004000	20x1/2"	NR	10	10	
6554004	C402 020006000	20x3/4"	NR	10	10	
6554005	C402 026006000	26x3/4"	NR	5	10	
6554006	C402 032008000	32x1"	NR	5	10	

RACCORDI A COMPRESSIONE PER MULTISTRATO ACQUA

GOMITO A 90° F/F



codice	sigla	Ø	UM	min. ord. conf.	cat.	prezzo (€)
6553001	C401 016000000	16	NR	10	10	
6553002	C401 020000000	20	NR	10	10	
6553003	C401 026000000	26	NR	5	10	
6553004	C401 032000000	32	NR	5	10	

GOMITO A 90° F/FILETTO F



codice	sigla	Ø	UM	min. ord. conf.	cat.	prezzo (€)
6555001	C403 016004000	16x1/2"	NR	10	10	
6555003	C403 020004000	20x1/2"	NR	10	10	
6555004	C403 020006000	20x3/4"	NR	10	10	
6555005	C403 026006000	26x3/4"	NR	5	10	
6555006	C403 026008000	26x1"	NR	5	10	
6555007	C403 032008000	32x1"	NR	5	10	

GOMITO A 90° F/FILETTO F CON FLANGIA A 2 FORI DI FISSAGGIO



codice	sigla	Ø	UM	min. ord. conf.	cat.	prezzo (€)
6556001	C403L016004000	16x1/2"	NR	10	10	
6556003	C403L020004000	20x1/2"	NR	5	10	

TEE F/F/F



codice	sigla	Ø	UM	min. ord. conf.	cat.	prezzo (€)
6557001	C601 016000000	16	NR	10	10	
6557002	C601 020000000	20	NR	5	10	
6557003	C601 026000000	26	NR	5	10	
6557004	C601 032000000	32	NR	5	10	

TEE F/FILETTO F/F



codice	sigla	Ø	UM	min. ord. conf.	cat.	prezzo (€)
6559001	C617 016004000	16x1/2"x16	NR	10	10	
6559003	C617 020004000	20x1/2"x20	NR	5	10	
6559004	C617 020006000	20x3/4"x20	NR	5	10	

RACCORDERIA IN OTTONE

RACCORDERIA CROMATA FILETTATURA CILINDRICA

Conforme alla normativa vigente per il tipo di lega:

- UNI EN 12165:11 CW617N per i particolari stampati
- UNI EN 12164:11 CW614N e UNI EN 12168:11 CW617N per i particolari da barra

Filettatura:

UNI ISO 228/1

GOMITO FEMMINA-FEMMINA



codice	sigla	Ø	UM	min. ord. conf.	cat.	prezzo (€)
● 2735021	00560300CR	3/8"	NR	10	06	
● 2735022	00560400CR	1/2"	NR	10	06	

GOMITO MASCHIO-FEMMINA



codice	sigla	Ø	UM	min. ord. conf.	cat.	prezzo (€)
● 2735011	00550300CR	3/8"	NR	10	06	
● 2735012	00550400CR	1/2"	NR	10	06	

TEE



codice	sigla	Ø	UM	min. ord. conf.	cat.	prezzo (€)
● 2735001	00540300CR	3/8"	NR	10	06	
● 2735002	00540400CR	1/2"	NR	10	06	

MANICOTTO



codice	sigla	Ø	UM	min. ord. conf.	cat.	prezzo (€)
● 2735111	00530300CR	3/8"	NR	10	06	
● 2735112	00530400CR	1/2"	NR	10	06	

RIDUZIONE



codice	sigla	Ø	UM	min. ord. conf.	cat.	prezzo (€)
● 2735132	06780430CR	1/2" M x 3/8" F	NR	10	06	
● 2735133	06780540CR	3/4" M x 1/2" F	NR	10	06	

NIPPLE



codice	sigla	Ø	UM	min. ord. conf.	cat.	prezzo (€)
● 2750223	00390300CR	3/8" x 3/8"	NR	10	06	
● 2750224	0039R340CR	3/8" x 1/2"	NR	10	06	
● 2750225	00390400CR	1/2" x 1/2"	NR	10	06	
● 2750226	0039R450CR	1/2" x 3/4"	NR	10	06	
● 2750227	00390500CR	3/4" x 3/4"	NR	10	06	

PROLUNGA RIDOTTA



codice	sigla	Ø	lung. (mm)	UM	min. ord. conf.	cat.	prezzo (€)
● 2735091	00520340CR	3/8" M x 1/2" F	14,5	NR	10	06	
● 2735092	00520450CR	1/2" M x 3/4" F	15	NR	10	06	

PROLUNGA



codice	sigla	Ø	lung. (mm)	UM	min. ord. conf.	cat.	prezzo (€)
● 2735060	00513010CR	3/8"	10	NR	10	06	
● 2735061	00513015CR	3/8"	15	NR	10	06	
● 2735062	00513020CR	3/8"	20	NR	10	06	
● 2735063	00513030CR	3/8"	30	NR	10	06	
● 2735051	00514010CR	1/2"	10	NR	10	06	
● 2735052	00514015CR	1/2"	15	NR	10	06	
● 2735053	00514020CR	1/2"	20	NR	10	06	
● 2735054	00514030CR	1/2"	30	NR	10	06	
● 2735055	00514040CR	1/2"	40	NR	10	06	
● 2735056	00514050CR	1/2"	50	NR	10	06	
● 2735057	00514060CR	1/2"	60	NR	10	06	
● 2735059	00514100CR	1/2"	100	NR	10	06	
● 2735069	00515010CR	3/4"	10	NR	10	06	
● 2735070	00515015CR	3/4"	15	NR	10	06	
● 2735071	00515020CR	3/4"	20	NR	10	06	

RACCORDERIA IN OTTONE

RACCORDERIA CROMATA FILETTATURA CILINDRICA

TAPPO FEMMINA



codice	sigla	Ø	UM	min. ord. conf.	cat.	prezzo (€)
● 2735181	06720300CR	3/8"	NR	10	06	
● 2735182	06720400CR	1/2"	NR	10	06	
● 2735183	06720500CR	3/4"	NR	10	06	

TAPPO MASCHIO



codice	sigla	Ø	UM	min. ord. conf.	cat.	prezzo (€)
● 2735141	06710300CR	3/8"	NR	10	06	
● 2735142	06710400CR	1/2"	NR	10	06	
● 2735143	06710500CR	3/4"	NR	10	06	

BICONI CROMATI

BICONO MASCHIO



codice	sigla	Ø	filetto (mm)	UM	min. ord. conf.	cat.	prezzo (€)
● 2750240	0321B330CR	3/8"x10	13	NR	10	06	
● 2750241	0320B330CR	3/8" x10	20	NR	10	06	
● 2750242	0320B342CR	3/8" x12	20	NR	10	06	
● 2750244	0321B430CR	1/2" x10	13	NR	10	06	
● 2750245	0320B430CR	1/2" x10	20	NR	10	06	
● 2750246	0320B442CR	1/2" x12	20	NR	10	06	
● 2750247	0320B444CR	1/2" x14	20	NR	10	06	

BICONO FEMMINA



codice	sigla	attacco Ø	calotta Ø	UM	min. ord. conf.	cat.	prezzo (€)
● 2750311	0041B330CR	3/8"	3/8"x10	NR	10	06	
● 2750313	0041B430CR	1/2"	3/8"x10	NR	10	06	
● 2750314	0041B440CR	1/2"	1/2"x10	NR	10	06	
● 2750315	0041B442CR	1/2"	1/2"x12	NR	10	06	
● 2750316	0041B444CR	1/2"	1/2"x14	NR	10	06	

BICONO DOPPIO



codice	sigla	calotta Ø	UM	min. ord. conf.	cat.	prezzo (€)
● 2750301	0040B310CR	3/8"x10	NR	10	06	

BICONO MASCHIO PROLUNGATO CON ROSONE



codice	sigla	attacco Ø	calotta Ø	UM	min. ord. conf.	cat.	prezzo (€)
● 2750251	0330C330CR	3/8"	3/8"x10	NR	2	06	
● 2750252	0330C430CR	1/2"	3/8"x10	NR	2	06	

PROLUNGA PER RETROGRUPPO CALOTTA GIREVOLE

Lunghezza 40 mm



codice	sigla	attacco Ø	foro Ø	UM	min. ord. conf.	cat.	prezzo (€)
● 2751122	00630530CR	3/4\"M x 3/4\"F	3/8"	NR	1	06	
● 2751123	0063F540CR	3/4\"M x 3/4\"F	1/2"	NR	1	06	
● 2751121	00620500CR	3/4\"M x 3/4\"F	-	NR	1	06	

BICONO DOPPIO A GOMITO



codice	sigla	calotta Ø	UM	min. ord. conf.	cat.	prezzo (€)
● 2750321	0042B310CR	3/8"x10	NR	10	06	

NIPPLE RIDOTTO PROLUNGATO CON ROSONE



codice	sigla	Ø	UM	min. ord. conf.	cat.	prezzo (€)
● 2750263	0330R430CR	1/2"x3/8"	NR	2	06	

NIPPLE RIDOTTO PROLUNGATO SENZA ROSONE



codice	sigla	Ø	UM	min. ord. conf.	cat.	prezzo (€)
● 2750264	03300430CR	1/2"x3/8"	NR	2	06	
● 2750266	03300442CR	1/2"x1/2"	NR	2	06	

PROLUNGA CON E SENZA CALOTTA

Lunghezza 40 mm



codice	sigla	attacco Ø	calotta Ø	UM	min. ord. conf.	cat.	prezzo (€)
● 2735041	0050B340CR	3/8"	3/8"x10	NR	10	06	
● 2735031	00500340CR	3/8"	-	NR	10	06	

RACCORDERIA IN OTTONE

RACCORDERIA CROMATA FILETTATURA CONICA

Conforme alla normativa vigente per il tipo di lega:

- UNI EN 12165 per i particolari stampati.
- UNI EN 12164 per i particolari da barra.
- Contenuto di piombo pari al 1,8% inferiore al limite ammesso dalla Direttiva Europea 98/83/CE (3,5%).

Filettatura:

UNI EN 10226-1 per l'accoppiamento a tenuta sul filetto: idonei per applicazioni con acqua calda e fredda, impianti di riscaldamento e di miscele acqua/glicole max. fino al 50%, per installazioni di solare termico, raffrescamento, aria compressa, gas combustibili, gas refrigeranti, settori industriale e navale meccanico.

GOMITO A 90° F/F



codice	sigla	Ø	UM	min. ord. conf.	cat.	prezzo (€)
1601000	8090 002C00000	1/4"	NR	10	01	
1601001	8090 003C00000	3/8"	NR	10	01	
1601002	8090 004C00000	1/2"	NR	10	01	
1601003	8090 006C00000	3/4"	NR	10	01	
1601004	8090 008C00000	1"	NR	10	01	

GOMITO A 90° M/F



codice	sigla	Ø	UM	min. ord. conf.	cat.	prezzo (€)
1602000	8092 002C00000	1/4"	NR	10	01	
1602001	8092 003C00000	3/8"	NR	10	01	
1602002	8092 004C00000	1/2"	NR	10	01	
1602003	8092 006C00000	3/4"	NR	10	01	
1602004	8092 008C00000	1"	NR	10	01	

TEE F/F/F



codice	sigla	Ø	UM	min. ord. conf.	cat.	prezzo (€)
1603000	8130 002C02002	1/4"	NR	10	01	
1603001	8130 003C03003	3/8"	NR	10	01	
1603002	8130 004C04004	1/2"	NR	10	01	
1603003	8130 006C06006	3/4"	NR	10	01	
1603004	8130 008C08008	1"	NR	5	01	

MANICOTTO F/F



codice	sigla	Ø	UM	min. ord. conf.	cat.	prezzo (€)
1604005	8270 002C00000	1/4"	NR	10	01	
1604001	8270 003C00000	3/8"	NR	10	01	
1604002	8270 004C00000	1/2"	NR	10	01	
1604003	8270 006C00000	3/4"	NR	10	01	
1604004	8270 008C00000	1"	NR	10	01	

MANICOTTO RIDOTTO F/F



codice	sigla	Ø	UM	min. ord. conf.	cat.	prezzo (€)
1614001	8240 006004C00	3/4"x1/2"	NR	10	01	
1614002	8240 008004C00	1"x1/2"	NR	10	01	
1614103	8240 008006C00	1"x3/4"	NR	10	01	

NIPPLO M/M



codice	sigla	Ø	UM	min. ord. conf.	cat.	prezzo (€)
1605000	8280 002C00000	1/4"	NR	10	01	
1605001	8280 003C00000	3/8"	NR	10	01	
1605002	8280 004C00000	1/2"	NR	10	01	
1605003	8280 006C00000	3/4"	NR	10	01	
1605004	8280 008C00000	1"	NR	10	01	

RACCORDERIA IN OTTONE

RACCORDERIA CROMATA FILETTATURA CONICA

NIPPLA RIDOTTO M/M



codice	sigla	Ø	UM	min. ord. conf.	cat.	prezzo (€)
1606000	8245 002001C00	1/4"x1/8"	NR	10	01	
1606003	8245 003002C00	3/8"x1/4"	NR	10	01	
1606005	8245 004002C00	1/2"x1/4"	NR	10	01	
1606001	8245 004003C00	1/2"x3/8"	NR	10	01	
1606006	8245 006003C00	3/4"x3/8"	NR	10	01	
1606002	8245 006004C00	3/4"x1/2"	NR	10	01	
1606007	8245 008004C00	1"x1/2"	NR	10	01	
1606004	8245 008006C00	1"x3/4"	NR	10	01	

RIDUZIONE M/F ESAGONALE



codice	sigla	Ø	UM	min. ord. conf.	cat.	prezzo (€)
1607000	8241 002001C00	1/4"x1/8"	NR	10	01	
1607006	8241 003001C00	3/8"x1/8"	NR	10	01	
1607007	8241 003002C00	3/8"x1/4"	NR	10	01	
1607008	8241 004002C00	1/2"x1/4"	NR	10	01	
1607001	8241 004003C00	1/2"x3/8"	NR	10	01	
1607009	8241 006002C00	3/4"x1/4"	NR	10	01	
1607010	8241 006003C00	3/4"x3/8"	NR	10	01	
1607002	8241 006004C00	3/4"x1/2"	NR	10	01	
1607011	8241 008003C00	1"x3/8"	NR	10	01	
1607012	8241 008004C00	1"x1/2"	NR	10	01	
1607003	8241 008006C00	1"x3/4"	NR	10	01	

PROLUNGA M/F, CON FILETTO CILINDRICO



codice	sigla	Ø	lung. (mm)	UM	min. ord. conf.	cat.	prezzo (€)
1609007	8540 003010C00	3/8"	10	NR	10	01	
1609000	8540 003015C00	3/8"	15	NR	10	01	
1609009	8540 003020C00	3/8"	20	NR	10	01	
1609015	8540 003025C00	3/8"	25	NR	10	01	
1609016	8540 003030C00	3/8"	30	NR	10	01	
1609017	8540 003040C00	3/8"	40	NR	10	01	
1609018	8540 003050C00	3/8"	50	NR	10	01	
1609001	8540 004010C00	1/2"	10	NR	10	01	
1609002	8540 004015C00	1/2"	15	NR	10	01	
1609003	8540 004020C00	1/2"	20	NR	10	01	
1609019	8540 004025C00	1/2"	25	NR	10	01	
1609004	8540 004030C00	1/2"	30	NR	10	01	
1609005	8540 004040C00	1/2"	40	NR	10	01	
1609006	8540 004050C00	1/2"	50	NR	10	01	
1609010	8540 004060C00	1/2"	60	NR	10	01	
1609021	8540 004070C00	1/2"	70	NR	10	01	
1609022	8540 004080C00	1/2"	80	NR	10	01	
1609012	8540 004100C00	1/2"	100	NR	10	01	
1609024	8540 006010C00	3/4"	10	NR	10	01	
1609025	8540 006015C00	3/4"	15	NR	10	01	
1609026	8540 006020C00	3/4"	20	NR	10	01	
1609027	8540 006025C00	3/4"	25	NR	10	01	
1609028	8540 006030C00	3/4"	30	NR	10	01	
1609029	8540 006040C00	3/4"	40	NR	10	01	
1609030	8540 006050C00	3/4"	50	NR	10	01	

TAPPO M, CON FILETTO CILINDRICO



codice	sigla	Ø	UM	min. ord. conf.	cat.	prezzo (€)
1612000	8292 002C00000	1/4"	NR	10	01	
1612001	8292 003C00000	3/8"	NR	10	01	
1612002	8292 004C00000	1/2"	NR	10	01	
1612003	8292 006C00000	3/4"	NR	10	01	
1612004	8292 008C00000	1"	NR	10	01	

TAPPO F



codice	sigla	Ø	UM	min. ord. conf.	cat.	prezzo (€)
1611004	8300 002C00000	1/4"	NR	10	01	
1611000	8300 003C00000	3/8"	NR	10	01	
1611001	8300 004C00000	1/2"	NR	10	01	
1611002	8300 006C00000	3/4"	NR	10	01	
1611003	8300 008C00000	1"	NR	10	01	

RIDUZIONE F/M, CON FILETTO CILINDRICO



codice	sigla	Ø	UM	min. ord. conf.	cat.	prezzo (€)
1608001	8243 004003C00	1/2"x3/8"	NR	10	01	
1608002	8243 006004C00	3/4"x1/2"	NR	10	01	
1608008	8243 008006C00	1"x3/4"	NR	10	01	

RACCORDERIA IN OTTONE

RACCORDERIA IN OTTONE GIALLO FILETTATURA CONICA

Conforme alla normativa vigente per il tipo di lega:

- UNI EN 12165 per i particolari stampati.
- UNI EN 12164 per i particolari da barra.
- Contenuto di piombo inferiore al limite ammesso dalla Direttiva Europea 98/83/CE.

Filettatura:

UNI EN 10226-1 per l'accoppiamento a tenuta sul filetto: idonei per applicazioni con acqua calda e fredda, impianti di riscaldamento e di miscele acqua/glicole max. fino al 50%, per installazioni di solare termico, raffrescamento, aria compressa, gas combustibili, gas refrigeranti e settori industriale e navale meccanico.

Tutti gli elementi elastomerici sono in EPDM nero conformi alla norma UNI EN 681-1: idonei per il trasporto di acque destinate al consumo umano (potabili)

GOMITO A 90° F/F



codice	sigla	Ø	UM	min. ord. conf.	cat.	prezzo (€)
1502000	8090 002000000	1/4"	NR	10	01	
1502004	8090 003000000	3/8"	NR	10	01	
1502001	8090 004000000	1/2"	NR	10	04	
1502002	8090 006000000	3/4"	NR	10	04	
1502003	8090 008000000	1"	NR	5	04	
1501004	8090 010000000	1"1/4	NR	5	01	
1501005	8090 012000000	1"1/2	NR	5	01	
1501006	8090 016000000	2"	NR	2	01	
1501107	8090 020000000	2"1/2	NR	1	01	

GOMITO A 90° RIDOTTO F/F



codice	sigla	Ø	UM	min. ord. conf.	cat.	prezzo (€)
1503004	8090R004003000	1/2"x3/8"	NR	10	01	
1503001	8090R006004000	3/4"x1/2"	NR	10	01	
1503003	8090R008006000	1"x3/4"	NR	5	01	

TEE F/F/F



codice	sigla	Ø	UM	min. ord. conf.	cat.	prezzo (€)
1513000	8130 002002002	1/4"	NR	10	01	
1513004	8130 003003003	3/8"	NR	10	01	
1513001	8130 004004004	1/2"	NR	10	04	
1513002	8130 006006006	3/4"	NR	10	04	
1513003	8130 008008008	1"	NR	5	04	
1512004	8130 010010010	1"1/4	NR	5	01	
1512005	8130 012012012	1"1/2	NR	1	01	
1512006	8130 016016016	2"	NR	1	01	
1512107	8130 020020020	2"1/2	NR	1	01	

GOMITO A 90° M/F



codice	sigla	Ø	UM	min. ord. conf.	cat.	prezzo (€)
1505000	8092 002000000	1/4"	NR	10	01	
1505004	8092 003000000	3/8"	NR	10	01	
1505001	8092 004000000	1/2"	NR	10	04	
1505002	8092 006000000	3/4"	NR	10	04	
1505003	8092 008000000	1"	NR	10	04	
1504004	8092 010000000	1"1/4	NR	5	01	
1504005	8092 012000000	1"1/2	NR	2	01	
1504006	8092 016000000	2"	NR	2	01	
1504107	8092 020000000	2"1/2	NR	1	01	

TEE RIDOTTO F/F/F



codice	sigla	Ø	UM	min. ord. conf.	cat.	prezzo (€)
1514000	8130R004003004	1/2"x3/8"x1/2"	NR	10	01	
1514002	8130R006004004	3/4"x1/2"x1/2"	NR	10	01	
1514001	8130R006004006	3/4"x1/2"x3/4"	NR	10	01	
1514006	8130R006006004	3/4"x3/4"x1/2"	NR	10	01	
1514003	8130R008004008	1"x1/2"x1"	NR	5	01	
1514005	8130R008006008	1"x3/4"x1"	NR	5	01	
1514009	8130R008008004	1"x1"x1/2"	NR	5	01	
1514010	8130R010004010	1"1/4x1/2"x1"1/4	NR	1	01	
1514011	8130R010006010	1"1/4x3/4"x1"1/4	NR	1	01	
1514007	8130R010008010	1"1/4"x1"x1"1/4	NR	5	01	
1514012	8130R012004012	1"1/2x1/2"x1"1/2	NR	1	01	
1514013	8130R012006012	1"1/2x3/4"x1"1/2	NR	1	01	
1514014	8130R012008012	1"1/2x1"x1"1/2	NR	1	01	

RACCORDERIA IN OTTONE GIALLO FILETTATURA CONICA

CROCE F/F/F/F



codice	sigla	Ø	UM	min. ord. conf.	cat.	prezzo (€)
1515001	8180 004000000	1/2"	NR	10	01	
1515002	8180 006000000	3/4"	NR	10	01	
1515003	8180 008000000	1"	NR	5	01	
1515104	8180 010000000	1"1/4	NR	1	01	
1515105	8180 012000000	1"1/2	NR	1	01	
1515106	8180 016000000	2"	NR	1	01	

RIDUZIONE ESAGONALE M/F



codice	sigla	Ø	UM	min. ord. conf.	cat.	prezzo (€)
1525000	8241 002001000	1/4"x1/8"	NR	10	01	
1525028	8241 003001000	3/8"x1/8"	NR	10	01	
1525015	8241 003002000	3/8"x1/4"	NR	10	01	
1525001	8241 004002000	1/2"x1/4"	NR	10	01	
1525002	8241 004003000	1/2"x3/8"	NR	10	01	
1525027	8241 006002000	3/4"x1/4"	NR	10	01	
1525016	8241 006003000	3/4"x3/8"	NR	10	01	
1525003	8241 006004000	3/4"x1/2"	NR	10	01	
1525020	8241 008003000	1"x3/8"	NR	10	01	
1525004	8241 008004000	1"x1/2"	NR	10	01	
1525005	8241 008006000	1"x3/4"	NR	10	01	
1525006	8241 010004000	1"1/4x1/2"	NR	5	01	
1525007	8241 010006000	1"1/4x3/4"	NR	5	01	
1525008	8241 010008000	1"1/4x1"	NR	5	01	
1525021	8241 012004000	1"1/2x1/2"	NR	5	01	
1525009	8241 012006000	1"1/2x3/4"	NR	5	01	
1525010	8241 012008000	1"1/2x1"	NR	5	01	
1525011	8241 012010000	1"1/2x1"1/4	NR	5	01	
1525022	8241 016006000	2"x3/4"	NR	1	01	
1525012	8241 016008000	2"x1"	NR	1	01	
1525013	8241 016010000	2"x1"1/4	NR	1	01	
1525014	8241 016012000	2"x1"1/2	NR	1	01	
1525123	8241 020016000	2"1/2x2"	NR	1	01	
1525024	8241 024016000	3"x2"	NR	1	01	
1525025	8241 024020000	3"x2"1/2	NR	1	01	

MANICOTTO F/F



codice	sigla	Ø	UM	min. ord. conf.	cat.	prezzo (€)
1516007	8270 002000000	1/4"	NR	10	01	
1516008	8270 003000000	3/8"	NR	10	01	
1516001	8270 004000000	1/2"	NR	10	01	
1516002	8270 006000000	3/4"	NR	10	01	
1516003	8270 008000000	1"	NR	10	01	
1516004	8270 010000000	1"1/4	NR	10	01	
1516005	8270 012000000	1"1/2	NR	5	01	
1516006	8270 016000000	2"	NR	1	01	

MANICOTTO RIDOTTO F/F



codice	sigla	Ø	UM	min. ord. conf.	cat.	prezzo (€)
1517001	8240 004003000	1/2"x3/8"	NR	10	01	
1517002	8240 006004000	3/4"x1/2"	NR	10	01	
1517003	8240 008004000	1"x1/2"	NR	10	01	
1517004	8240 008006000	1"x3/4"	NR	10	01	
1517011	8240 010006000	1"1/4x3/4"	NR	5	01	
1517005	8240 010008000	1"1/4x1"	NR	5	01	
1517007	8240 012010000	1"1/2x1"1/4	NR	1	01	
1517009	8240 016012000	2"x1"1/2	NR	1	01	

NIPPLLO M/M



codice	sigla	Ø	UM	min. ord. conf.	cat.	prezzo (€)
1518010	8280 002000000	1/4"	NR	10	01	
1518011	8280 003000000	3/8"	NR	10	01	
1519001	8280 004000000	1/2"	NR	10	04	
1519002	8280 006000000	3/4"	NR	10	04	
1519003	8280 008000000	1"	NR	10	04	
1518004	8280 010000000	1"1/4	NR	10	01	
1518005	8280 012000000	1"1/2	NR	5	01	
1518006	8280 016000000	2"	NR	5	01	
1518107	8280 020000000	2"1/2	NR	1	01	

RACCORDERIA IN OTTONE

RACCORDERIA IN OTTONE GIALLO FILETTATURA CONICA

NIPPLO RIDOTTO M/M



codice	sigla	Ø	UM	min. ord. conf.	cat.	prezzo (€)
1520000	8245 002001000	1/4"x3/8"	NR	10	01	
1520010	8245 003002000	3/8"x1/4"	NR	10	01	
1520011	8245 004002000	1/2"x1/4"	NR	10	01	
1520001	8245 004003000	1/2"x3/8"	NR	10	01	
1520012	8245 006003000	3/4"x3/8"	NR	10	01	
1520002	8245 006004000	3/4"x1/2"	NR	10	01	
1520003	8245 008004000	1"x1/2"	NR	10	01	
1520004	8245 008006000	1"x3/4"	NR	10	01	
1520013	8245 010006000	1"1/4x3/4"	NR	5	01	
1520005	8245 010008000	1"1/4x1"	NR	5	01	
1520014	8245 012006000	1"1/2x3/4"	NR	5	01	
1520006	8245 012008000	1"1/2x1"	NR	5	01	
1520007	8245 012010000	1"1/2x1"1/4	NR	5	01	
1520018	8245 016010000	2"x1"1/4	NR	1	01	
1520009	8245 016012000	2"x1"1/2	NR	1	01	
1520116	8245 020016000	2"1/2x2"	NR	1	01	

TAPPO F



codice	sigla	Ø	UM	min. ord. conf.	cat.	prezzo (€)
1522000	8300 002000000	1/4"	NR	10	01	
1522007	8300 003000000	3/8"	NR	10	01	
1522001	8300 004000000	1/2"	NR	10	01	
1522002	8300 006000000	3/4"	NR	10	01	
1522003	8300 008000000	1"	NR	10	01	
1522004	8300 010000000	1"1/4	NR	10	01	
1522005	8300 012000000	1"1/2	NR	2	01	
1522006	8300 016000000	2"	NR	2	01	

NIPPLO A TUTTO FILETTO M/M, C/ FILETTO CILINDRICO



codice	sigla	Ø	UM	min. ord. conf.	cat.	prezzo (€)
1523007	8531 003000000	3/8"	NR	10	01	
1523001	8531 004000000	1/2"	NR	10	01	
1523002	8531 006000000	3/4"	NR	10	01	
1523003	8531 008000000	1"	NR	5	01	
1523104	8531 010000000	1"1/4	NR	1	01	
1523105	8531 012000000	1"1/2	NR	1	01	
1523106	8531 016000000	2"	NR	1	01	

TAPPO M, CON FILETTO CILINDRICO



codice	sigla	Ø	UM	min. ord. conf.	cat.	prezzo (€)
1521001	8292 002000000	1/4"	NR	10	01	
1521002	8292 003000000	3/8"	NR	10	01	
1521003	8292 004000000	1/2"	NR	10	01	
1521004	8292 006000000	3/4"	NR	10	01	
1521005	8292 008000000	1"	NR	10	01	

TAPPO M, CON QUADRO E FILETTO CILINDRICO



codice	sigla	Ø	UM	min. ord. conf.	cat.	prezzo (€)
1544001	8595 002000000	1/4"	NR	10	01	
1544002	8595 003000000	3/8"	NR	10	01	
1544003	8595 004000000	1/2"	NR	10	01	
1544004	8595 006000000	3/4"	NR	10	01	
1544005	8595 008000000	1"	NR	10	01	
1544006	8595 010000000	1"1/4	NR	5	01	
1544007	8595 012000000	1"1/2	NR	5	01	
1544008	8595 016000000	2"	NR	2	01	

CONTRODADO



codice	sigla	Ø	UM	min. ord. conf.	cat.	prezzo (€)
1537000	8310 002000000	1/4"	NR	10	01	
1537004	8310 003000000	3/8"	NR	10	01	
1537001	8310 004000000	1/2"	NR	10	01	
1537002	8310 006000000	3/4"	NR	10	01	
1537003	8310 008000000	1"	NR	10	01	
1537005	8310 010000000	1"1/4	NR	10	01	
1537006	8310 012000000	1"1/2	NR	5	01	
1537007	8310 016000000	2"	NR	5	01	

GOMITO A 90° F/F, C/FLANGIA A 2 FORI DI FISSAGGIO



codice	sigla	Ø	UM	min. ord. conf.	cat.	prezzo (€)
1550001	8471 004000000	1/2"	NR	10	01	
1550002	8471 006000000	3/4"	NR	10	01	

RACCORDERIA IN OTTONE

RACCORDERIA IN OTTONE GIALLO FILETTATURA CONICA

GHIERA DI RIDUZIONE M/F



codice	sigla	Ø	UM	min. ord. conf.	cat.	prezzo (€)
1528001	8198 004003000	1/2"x3/8"	NR	10	01	
1528002	8198 006004000	3/4"x1/2"	NR	10	01	
1528003	8198 008006000	1"x3/4"	NR	10	01	
1528004	8198 010008000	1"1/4x1"	NR	10	01	
1528105	8198 012010000	1"1/2x1"1/4	NR	5	01	

BARILOTTO M/M



codice	sigla	Ø	lung. (mm)	UM	min. ord. conf.	cat.	prezzo (€)
1535000	8530 004050000	1/2"	50	NR	10	01	
1535001	8530 004060000	1/2"	60	NR	10	01	
1535013	8530 004080000	1/2"	80	NR	10	01	
1535002	8530 004100000	1/2"	100	NR	10	01	
1535014	8530 004120000	1/2"	120	NR	10	01	
1535015	8530 004150000	1/2"	150	NR	5	01	
1535016	8530 004180000	1/2"	180	NR	5	01	
1535010	8530 004200000	1/2"	200	NR	5	01	
1535017	8530 006050000	3/4"	50	NR	10	01	
1535003	8530 006060000	3/4"	60	NR	10	01	
1535018	8530 006080000	3/4"	80	NR	10	01	
1535004	8530 006100000	3/4"	100	NR	10	01	
1535019	8530 006120000	3/4"	120	NR	10	01	
1535020	8530 006150000	3/4"	150	NR	5	01	
1535021	8530 006180000	3/4"	180	NR	5	01	
1535011	8530 006200000	3/4"	200	NR	5	01	
1535022	8530 008050000	1"	50	NR	5	01	
1535005	8530 008060000	1"	60	NR	5	01	
1535023	8530 008080000	1"	80	NR	5	01	
1535006	8530 008100000	1"	100	NR	5	01	
1535038	8530 008120000	1"	120	NR	5	01	
1535025	8530 008150000	1"	150	NR	5	01	
1535026	8530 008180000	1"	180	NR	5	01	
1535012	8530 008200000	1"	200	NR	5	01	
1535008	8530 010100000	1"1/4	100	NR	5	01	
1535029	8530 010150000	1"1/4	150	NR	1	01	
1535031	8530 010200000	1"1/4	200	NR	1	01	
1535009	8530 012100000	1"1/2	100	NR	1	01	
1535035	8530 012150000	1"1/2	150	NR	1	01	
1535037	8530 012200000	1"1/2	200	NR	1	01	

PROLUNGA M/F, CON FILETTO CILINDRICO



codice	sigla	Ø	lung. (mm)	UM	min. ord. conf.	cat.	prezzo (€)
1532001	8540 003010000	3/8"	10	NR	10	01	
1532025	8540 003015000	3/8"	15	NR	10	01	
1532002	8540 003020000	3/8"	20	NR	10	01	
1532026	8540 003025000	3/8"	25	NR	10	01	
1532003	8540 003030000	3/8"	30	NR	10	01	
1532004	8540 003040000	3/8"	40	NR	10	01	
1532005	8540 003050000	3/8"	50	NR	10	01	
1533001	8540 004010000	1/2"	10	NR	10	01	
1533002	8540 004015000	1/2"	15	NR	10	01	
1533003	8540 004020000	1/2"	20	NR	10	01	
1532009	8540 004025000	1/2"	25	NR	10	01	
1533004	8540 004030000	1/2"	30	NR	10	01	
1532011	8540 004040000	1/2"	40	NR	10	01	
1532012	8540 004050000	1/2"	50	NR	10	01	
1532013	8540 004060000	1/2"	60	NR	10	01	
1532027	8540 004070000	1/2"	70	NR	10	01	
1532028	8540 004080000	1/2"	80	NR	10	01	
1532029	8540 004100000	1/2"	100	NR	10	01	
1532014	8540 006010000	3/4"	10	NR	10	01	
1532015	8540 006015000	3/4"	15	NR	10	01	
1532016	8540 006020000	3/4"	20	NR	10	01	
1532030	8540 006025000	3/4"	25	NR	10	01	
1532017	8540 006030000	3/4"	30	NR	10	01	
1532018	8540 006040000	3/4"	40	NR	10	01	
1532019	8540 006050000	3/4"	50	NR	10	01	
1532021	8540 008010000	1"	10	NR	5	01	
1532022	8540 008015000	1"	15	NR	5	01	
1532023	8540 008020000	1"	20	NR	5	01	
1532031	8540 008025000	1"	25	NR	5	01	
1532024	8540 008030000	1"	30	NR	5	01	
1532032	8540 008040000	1"	40	NR	5	01	
1532033	8540 008050000	1"	50	NR	5	01	
1532034	8540 008060000	1"	60	NR	5	01	

RIDUZIONE F/M, CON FILETTO CILINDRICO



codice	sigla	Ø	UM	min. ord. conf.	cat.	prezzo (€)
1534000	8243 002001000	1/4"x1/8"	NR	10	01	
1534005	8243 003002000	3/8"x1/4"	NR	10	01	
1534006	8243 004002000	1/2"x1/4"	NR	10	01	
1534001	8243 004003000	1/2"x3/8"	NR	10	01	
1534007	8243 006003000	3/4"x3/8"	NR	10	01	
1534002	8243 006004000	3/4"x1/2"	NR	10	01	
1534003	8243 008004000	1"x1/2"	NR	10	01	
1534004	8243 008006000	1"x3/4"	NR	10	01	
1534008	8243 010004000	1"1/4x1/2"	NR	5	01	
1534009	8243 010006000	1"1/4x3/4"	NR	5	01	
1534010	8243 010008000	1"1/4x1"	NR	5	01	

RACCORDERIA IN OTTONE

RACCORDERIA IN OTTONE GIALLO FILETTATURA CONICA

SCORREVOLE M/M, CON FILETTO CILINDRICO



codice	sigla	Ø	UM	min. ord. conf.	cat.	prezzo (€)
1545001	8532 004150000	1/2"x150 mm.	NR	1	01	
1545002	8532 004200000	1/2"x200 mm.	NR	1	01	
1545003	8532 006150000	3/4"x150 mm.	NR	1	01	
1545005	8532 008150000	1"x150 mm.	NR	1	01	

RACCORDO PER CISTERNA



codice	sigla	Ø	UM	min. ord. conf.	cat.	prezzo (€)
1546001	8535 004000000	1/2"	NR	10	01	
1546002	8535 006000000	3/4"	NR	5	01	
1546003	8535 008000000	1"	NR	5	01	
1546004	8535 010000000	1"1/4	NR	2	01	
1546005	8535 012000000	1"1/2	NR	1	01	
1546006	8535 016000000	2"	NR	1	01	

BOCCHETTONE F/F, A TENUTA METALLICA



codice	sigla	Ø	UM	min. ord. conf.	cat.	prezzo (€)
1508001	8125 004000000	1/2"	NR	5	01	
1508002	8125 006000000	3/4"	NR	10	01	
1508003	8125 008000000	1"	NR	5	01	

BOCCHETTONE M/F, A TENUTA METALLICA



codice	sigla	Ø	UM	min. ord. conf.	cat.	prezzo (€)
1509001	8126 004000000	1/2"	NR	10	01	
1509002	8126 006000000	3/4"	NR	10	01	
1509003	8126 008000000	1"	NR	5	01	

BOCCHETTONE M/F, A TENUTA O-RING (solo per acqua)



codice	sigla	Ø	UM	min. ord. conf.	cat.	prezzo (€)
1510000	8126G003000000	3/8"	NR	10	01	
1510001	8126G004000000	1/2"	NR	10	05	
1510002	8126G006000000	3/4"	NR	10	05	
1510003	8126G008000000	1"	NR	5	05	
1510004	8126G010000000	1"1/4	NR	5	01	
1510005	8126G012000000	1"1/2	NR	1	01	
1510006	8126G016000000	2"	NR	1	01	

BOCCHETTONE 90° M/F, A TENUTA O-RING (solo per acqua)



codice	sigla	Ø	UM	min. ord. conf.	cat.	prezzo (€)
1511007	8098G003000000	3/8"	NR	10	01	
1511001	8098G004000000	1/2"	NR	10	05	
1511002	8098G006000000	3/4"	NR	10	05	
1511003	8098G008000000	1"	NR	5	05	
1511004	8098G010000000	1"1/4	NR	5	01	
1511005	8098G012000000	1"1/2	NR	1	01	
1511006	8098G016000000	2"	NR	1	01	

RACCORDERIA IN OTTONE GIALLO FILETTATURA CILINDRICA

Conforme alla normativa vigente per il tipo di lega:

- UNI EN 12165 per i particolari stampati.
- UNI EN 12164 per i particolari da barra.
- Contenuto di piombo inferiore al limite ammesso dalla Direttiva Europea 98/83/CE

Filettatura:

Raccordi in ottone CW617N-DW con filettatura secondo ISO 228-1. Idonei per applicazioni con acqua calda e fredda, impianti di riscaldamento, solare termico con miscele acqua/glicole max. fino al 50%, raffrescamento, aria compressa (priva di olii).

Tutti gli elementi elastomerici sono in EPDM nero conformi alla norma UNI EN 681-1: idonei per il trasporto di acque destinate al consumo umano (potabili)

GOMITO A 90° F/F



codice	sigla	Ø	UM	min. ord. conf.	cat.	prezzo (€)
1502201	8090 M04000000	1/2"	NR	10	05	
1502202	8090 M06000000	3/4"	NR	10	05	
1502203	8090 M08000000	1"	NR	5	05	

GOMITO A 90° M/F



codice	sigla	Ø	UM	min. ord. conf.	cat.	prezzo (€)
1505201	8092 M04000000	1/2"	NR	10	05	
1505202	8092 M06000000	3/4"	NR	10	05	
1505203	8092 M08000000	1"	NR	10	05	

MANICOTTO F/F



codice	sigla	Ø	UM	min. ord. conf.	cat.	prezzo (€)
1516201	8270 M04000000	1/2"	NR	10	05	
1516202	8270 M06000000	3/4"	NR	10	05	
1516203	8270 M08000000	1"	NR	10	05	

MANICOTTO RIDOTTO F/F



codice	sigla	Ø	UM	min. ord. conf.	cat.	prezzo (€)
1517202	8240 M06004000	3/4"x1/2"	NR	10	05	
1517203	8240 M08004000	1"x1/2"	NR	5	05	
1517204	8240 M08006000	1"x3/4"	NR	5	05	

NIPPLLO M/M



codice	sigla	Ø	UM	min. ord. conf.	cat.	prezzo (€)
1519200	8280 M03000000	3/8"	NR	10	05	
1519201	8280 M04000000	1/2"	NR	10	05	
1519202	8280 M06000000	3/4"	NR	10	05	
1519203	8280 M08000000	1"	NR	10	05	

NIPPLLO RIDOTTO M/M



codice	sigla	Ø	UM	min. ord. conf.	cat.	prezzo (€)
1520201	8245 M04003000	1/2"x3/8"	NR	10	05	
1520202	8245 M06004000	3/4"x1/2"	NR	10	05	
1520203	8245 M08004000	1"x1/2"	NR	10	05	
1520204	8245 M08006000	1"x3/4"	NR	10	05	

TEE F/F/F



codice	sigla	Ø	UM	min. ord. conf.	cat.	prezzo (€)
1513201	8130 M04004004	1/2"	NR	10	05	
1513202	8130 M06006006	3/4"	NR	10	05	
1513203	8130 M08008008	1"	NR	5	05	

BOCCHETTONE M/F, A TENUTA O-RING



codice	sigla	Ø	UM	min. ord. conf.	cat.	prezzo (€)
1510201	8126GM04000000	1/2"	NR	10	05	
1510202	8126GM06000000	3/4"	NR	10	05	
1510203	8126GM08000000	1"	NR	5	05	

RACCORDERIA IN OTTONE

RACCORDERIA IN OTTONE GIALLO FILETTATURA CILINDRICA

RIDUZIONE ESAGONALE M/F



codice	sigla	Ø	UM	min. ord. conf.	cat.	prezzo (€)
1525207	8241 M03002000	3/8"x1/4"	NR	10	05	
1525201	8241 M04002000	1/2"x1/4"	NR	10	05	
1525202	8241 M04003000	1/2"x3/8"	NR	10	05	
1525216	8241 M06003000	3/4"x3/8"	NR	10	05	
1525203	8241 M06004000	3/4"x1/2"	NR	10	05	
1525204	8241 M08004000	1"x1/2"	NR	10	05	
1525205	8241 M08006000	1"x3/4"	NR	10	05	
1525208	8241 M10004000	1"1/4x1/2"	NR	5	05	
1525209	8241 M10006000	1"1/4x3/4"	NR	5	05	
1525210	8241 M10008000	1"1/4x1"	NR	5	05	
1525211	8241 M12004000	1"1/2x1/2"	NR	5	05	
1525213	8241 M12008000	1"1/2x1"	NR	5	05	
1525214	8241 M12010000	1"1/2x1"1/4	NR	5	05	
1525215	8241 M16004000	2"x1/2"	NR	1	05	

PROLUNGA M/F



codice	sigla	Ø	lung. (mm)	UM	min. ord. conf.	cat.	prezzo (€)
1533201	8540 M04010000	1/2"	10	NR	10	05	
1533202	8540 M04015000	1/2"	15	NR	10	05	
1533203	8540 M04020000	1/2"	20	NR	10	05	
1533204	8540 M04030000	1/2"	30	NR	10	05	
1533206	8540 M04040000	1/2"	40	NR	10	05	
1532214	8540 M06010000	3/4"	10	NR	10	05	
1532215	8540 M06015000	3/4"	15	NR	10	05	
1532216	8540 M06020000	3/4"	20	NR	10	05	
1532217	8540 M06030000	3/4"	30	NR	10	05	
1532211	8540 M06040000	3/4"	40	NR	10	05	
1532212	8540 M06050000	3/4"	50	NR	5	05	
1532221	8540 M08030000	1"	30	NR	10	05	

PROLUNGA RIDOTTA F/M



codice	sigla	Ø	UM	min. ord. conf.	cat.	prezzo (€)
1534201	8243 M04003000	1/2"x3/8"	NR	10	05	
1534202	8243 M06004000	3/4"x1/2"	NR	10	05	
1534203	8243 M08004000	1"x1/2"	NR	10	05	
1534204	8243 M08006000	1"x3/4"	NR	10	05	
1534211	8243 M10008000	1"1/4x1"	NR	5	05	
1534212	8243 M12010000	1"1/2x1"1/4	NR	5	05	

TAPPO M



codice	sigla	Ø	UM	min. ord. conf.	cat.	prezzo (€)
1521203	8292 M04000000	1/2"	NR	10	05	
1521204	8292 M06000000	3/4"	NR	10	05	
1521205	8292 M08000000	1"	NR	5	05	
1521206	8292 M10000000	1"1/4	NR	5	05	

PORTAGOMMA M, TIPO ROMA



codice	sigla	Ø	UM	min. ord. conf.	cat.	prezzo (€)
1526301	81004M03010000	3/8"x10 mm.	NR	10	05	
1526302	81004M04010000	1/2"x10 mm.	NR	10	05	
1526304	81004M04014000	1/2"x14 mm.	NR	10	05	
1526305	81004M04016000	1/2"x16 mm.	NR	10	05	
1526306	81004M04018000	1/2"x18 mm.	NR	10	05	
1526307	81004M04020000	1/2"x20 mm.	NR	10	05	
1526308	81004M06020000	3/4"x20 mm.	NR	10	05	
1526309	81004M06025000	3/4"x25 mm.	NR	10	05	
1526310	81004M08025000	1"x25 mm.	NR	5	05	
1526311	81004M08030000	1"x30 mm.	NR	5	05	
1526312	81004M12040000	1"1/2x40 mm.	NR	5	05	

TAPPO F



codice	sigla	Ø	UM	min. ord. conf.	cat.	prezzo (€)
1522201	8300 M04000000	1/2"	NR	10	05	
1522202	8300 M06000000	3/4"	NR	10	05	
1522203	8300 M08000000	1"	NR	5	05	

PORTAGOMMA F, TIPO ROMA



codice	sigla	Ø	UM	min. ord. conf.	cat.	prezzo (€)
1527300	81005M04010000	1/2"x10 mm.	NR	10	05	
1527302	81005M04014000	1/2"x14 mm.	NR	10	05	
1527306	81005M06020000	3/4"x20 mm.	NR	10	05	
1527307	81005M08025000	1"x25 mm.	NR	5	05	

Conforme alla norma UNI EN 1254 parti 2 e 4.
Certificata DVGW.

A tenuta metallica

UTILIZZO CON UN UNICO RACCORDO PER:

- Acqua
- Aria compressa
- Gas
- Solare (concentrazione Glicole max 50%)

I raccordi possono essere utilizzati con tubazioni:

- Rame (secondo EN 1057)
- Acciaio inox (secondo EN 10312)
- Acciaio al carbonio (secondo EN 10305-3)
- Polietilene reticolato e media densità

MANICOTTO F/F



codice	sigla	Ø	UM	min. ord. conf.	cat.	prezzo (€)
6500001	AA-5020301--	6	NR	10	07	
6500003	BB-5020301--	8	NR	10	07	
6500004	CC-5020301--	10	NR	10	07	
6500006	DD-1020301--	12	NR	10	07	
6500009	TT-1020301--	14	NR	10	07	
6500010	EE-1020301--	15	NR	10	07	
6500014	UU-1020301--	16	NR	10	07	
6500016	FF-1020301--	18	NR	10	07	
6500020	GG-1020301--	22	NR	10	07	

MANICOTTO F/FILETTO M, CON FILETTO CONICO



codice	sigla	Ø	UM	min. ord. conf.	cat.	prezzo (€)
6503004	D021020302TA	12x3/8"	NR	10	07	
6503003	D031020302TA	12x1/2"	NR	10	07	
6503016	T031020302TA	14x1/2"	NR	10	07	
6503005	E031020302TA	15x1/2"	NR	10	07	
6503017	U031020302TA	16x1/2"	NR	10	07	
6503008	U041020302TA	16x3/4"	NR	10	07	
6503009	F031020302TA	18x1/2"	NR	10	07	
6503010	F041020302TA	18x3/4"	NR	10	07	
6503012	G031020302TA	22x1/2"	NR	10	07	
6503013	G041020302TA	22x3/4"	NR	10	07	
6503011	G051020302TA	22x1"	NR	10	07	
6503014	H051020302TA	28x1"	NR	10	07	

MANICOTTO F/FILETTO M, CON FILETTO CILINDRICO



codice	sigla	Ø	UM	min. ord. conf.	cat.	prezzo (€)
6502002	A011020302--	6x1/4"	NR	10	07	
6502005	B015020302--	8x1/4"	NR	10	07	
6502003	B025020302--	8x3/8"	NR	10	07	
6502008	C025020302--	10x3/8"	NR	10	07	
6502006	C035020302--	10x1/2"	NR	10	07	
6502011	D021020302--	12x3/8"	NR	10	07	
6502009	D031020302--	12x1/2"	NR	10	07	
6502012	E031020302--	15x1/2"	NR	10	07	
6502016	F031020302--	18x1/2"	NR	10	07	
6502017	F041020302--	18x3/4"	NR	10	07	
6502022	G041020302--	22x3/4"	NR	10	07	
6502020	G051020302--	22x1"	NR	10	07	
6502023	H051020302--	28x1"	NR	10	07	
6502027	J061020302--	35x1"1/4	NR	1	07	

MANICOTTO F/FILETTO F



codice	sigla	Ø	UM	min. ord. conf.	cat.	prezzo (€)
6504003	C025020303--	10x3/8"	NR	10	07	
6504001	C035020303--	10x1/2"	NR	10	07	
6504005	D021020303--	12x3/8"	NR	10	07	
6504004	D031020303--	12x1/2"	NR	10	07	
6504006	T031020303--	14x1/2"	NR	10	07	
6504008	E031020303--	15x1/2"	NR	10	07	
6504011	U031020303--	16x1/2"	NR	10	07	
6504012	U041020303--	16x3/4"	NR	10	07	
6504013	F031020303--	18x1/2"	NR	10	07	
6504014	F041020303--	18x3/4"	NR	10	07	
6504019	G041020303--	22x3/4"	NR	10	07	
6504017	G051020303--	22x1"	NR	10	07	
6504022	H041020303--	28x3/4"	NR	10	07	
6504020	H051020303--	28x1"	NR	10	07	

GOMITO A 90° F/F



codice	sigla	Ø	UM	min. ord. conf.	cat.	prezzo (€)
6506003	CC-5020401--	10	NR	10	07	
6506004	DD-1020401--	12	NR	10	07	
6506005	TT-1020401--	14	NR	10	07	
6506009	UU-1020401--	16	NR	10	07	
6506010	FF-1020401--	18	NR	10	07	
6506013	GG-1020401--	22	NR	10	07	

RACCORDERIA IN OTTONE

CONEX COMPRESSION

GOMITO A 90° F FILETTO M, CON FILETTO CILINDRICO



codice	sigla	Ø	UM	min. ord. conf.	cat.	prezzo (€)
6507001	C035020402--	10x1/2"	NR	10	07	
6507003	D035020402--	12x1/2"	NR	10	07	
6507009	F045020402--	18x3/4"	NR	10	07	
6507013	G041020402--	22x3/4"	NR	10	07	

GOMITO A 90° F/FILETTO M, CON FILETTO CONICO



codice	sigla	Ø	UM	min. ord. conf.	cat.	prezzo (€)
6508002	D031020402TA	12x1/2"	NR	10	07	
6508004	T031020402TA	14x1/2"	NR	10	07	
6508008	U031020402TA	16x1/2"	NR	10	07	
6508011	F041020402TA	18x3/4"	NR	10	07	
6508013	G041020402TA	22x3/4"	NR	10	07	

GOMITO A 90° F/FILETTO F



codice	sigla	Ø	UM	min. ord. conf.	cat.	prezzo (€)
6509003	C025020403--	10x3/8"	NR	10	07	
6509002	C035020403--	10x1/2"	NR	10	07	
6509004	D031020403--	12x1/2"	NR	10	07	
6509006	T031020403--	14x1/2"	NR	10	07	
6509010	U031020403--	16x1/2"	NR	10	07	
6509011	U041020403--	16x3/4"	NR	10	07	
6509012	F031020403--	18x1/2"	NR	10	07	
6509013	F045020403--	18x3/4"	NR	10	07	
6509017	G041020403--	22x3/4"	NR	10	07	

GOMITO A 90° F/FILETTO F, CON FLANGIA A 2 FORI DI FISSAGGIO



codice	sigla	Ø	UM	min. ord. conf.	cat.	prezzo (€)
6510002	D031020403W-	12x1/2"	NR	10	07	
6510001	T031020403W-	14x1/2"	NR	10	07	
6510003	E031020403W-	15x1/2"	NR	10	07	

GOMITO A 90° F/FILETTO F, CON FLANGIA A 3 FORI DI FISSAGGIO



codice	sigla	Ø	UM	min. ord. conf.	cat.	prezzo (€)
6511001	D035020403WL	12x1/2"	NR	10	07	



Corpo raccordo conforme alle norme UNI EN 1254-2, UNI EN 1254-4

APPLICAZIONI PER ACQUA:

- O-ring nero EPDM conforme alla norma UNI EN 681-1.
- Elemento elastomerico di colore nero idoneo per il trasporto e la distribuzione di acque destinate al consumo umano.
- Installazione per impianti di acqua sanitaria fredda e calda, di riscaldamento e di miscele acqua/glicole fino al 50%.
- Pressioni massime di esercizio:
 - 16 bar per temperature di 95°
 - 10 bar per temperature di 110°

APPLICAZIONI PER GAS:

- O-ring giallo HNBR conforme alla norma DIN EN 549.
- Elemento elastomerico di colore giallo idoneo alla realizzazione di impianti per trasporto e/o distribuzione di combustibili liquidi e gassosi.
- Famiglie di gas combustibili:
 - 1^a (gruppo A-gas manifatturato)
 - 2^a (gruppo H-gas naturale o metano)
 - 3^a (GPL)

In ogni confezione ci sono in dotazione gli O-ring giallo e nero.

MANICOTTO DIRITTO F/F



codice	sigla	Ø	UM	min. ord. conf.	cat.	prezzo (€)
6601001	IG301 01000000	10	NR	1	01	
6601002	IG301 01200000	12	NR	1	01	
6601003	IG301 01400000	14	NR	1	01	
6601004	IG301 01600000	16	NR	1	01	
6601005	IG301 01800000	18	NR	1	01	
6601006	IG301 02200000	22	NR	1	01	
6601007	IG301 02800000	28	NR	1	01	

MANICOTTO F/FILETTO M



codice	sigla	Ø	UM	min. ord. conf.	cat.	prezzo (€)
6602001	IG302 01003000	10x3/8"	NR	1	01	
6602002	IG302 01004000	10x1/2"	NR	1	01	
6602003	IG302 01203000	12x3/8"	NR	1	01	
6602004	IG302 01204000	12x1/2"	NR	1	01	
6602005	IG302 01403000	14x3/8"	NR	1	01	
6602006	IG302 01404000	14x1/2"	NR	1	01	
6602007	IG302 01406000	14x3/4"	NR	1	01	
6602009	IG302 01604000	16x1/2"	NR	1	01	
6602010	IG302 01606000	16x3/4"	NR	1	01	
6602011	IG302 01804000	18x1/2"	NR	1	01	
6602012	IG302 01806000	18x3/4"	NR	1	01	
6602015	IG302 02206000	22x3/4"	NR	1	01	
6602016	IG302 02208000	22x1"	NR	1	01	
6602017	IG302 02806000	28x3/4"	NR	1	01	
6602018	IG302 02808000	28x1"	NR	1	01	

MANICOTTO F/FILETTO F



codice	sigla	Ø	UM	min. ord. conf.	cat.	prezzo (€)
6603001	IG303 01003000	10x3/8"	NR	1	01	
6603002	IG303 01004000	10x1/2"	NR	1	01	
6603003	IG303 01203000	12x3/8"	NR	1	01	
6603004	IG303 01204000	12x1/2"	NR	1	01	
6603005	IG303 01403000	14x3/8"	NR	1	01	
6603006	IG303 01404000	14x1/2"	NR	1	01	
6603007	IG303 01406000	14x3/4"	NR	1	01	
6603009	IG303 01604000	16x1/2"	NR	1	01	
6603010	IG303 01606000	16x3/4"	NR	1	01	
6603011	IG303 01804000	18x1/2"	NR	1	01	
6603012	IG303 01806000	18x3/4"	NR	1	01	
6603015	IG303 02206000	22x3/4"	NR	1	01	
6603016	IG303 02208000	22x1"	NR	1	01	
6603017	IG303 02806000	28x3/4"	NR	1	01	
6603018	IG303 02808000	28x1"	NR	1	01	

GOMITO A 90° F/F



codice	sigla	Ø	UM	min. ord. conf.	cat.	prezzo (€)
6604001	IG401 01000000	10	NR	1	01	
6604002	IG401 01200000	12	NR	1	01	
6604003	IG401 01400000	14	NR	1	01	
6604004	IG401 01600000	16	NR	1	01	
6604005	IG401 01800000	18	NR	1	01	
6604006	IG401 02200000	22	NR	1	01	

RACCORDERIA IN OTTONE

CONEX O-RING ACQUA E GAS

GOMITO A 90° F/FILETTO M



codice	sigla	Ø	UM	min. ord. conf.	cat.	prezzo (€)
6605002	IG402 01004000	10x1/2"	NR	1	01	
6605003	IG402 01203000	12x3/8"	NR	1	01	
6605004	IG402 01204000	12x1/2"	NR	1	01	
6605006	IG402 01404000	14x1/2"	NR	1	01	
6605009	IG402 01604000	16x1/2"	NR	1	01	
6605010	IG402 01606000	16x3/4"	NR	1	01	
6605011	IG402 01804000	18x1/2"	NR	1	01	
6605012	IG402 01806000	18x3/4"	NR	1	01	
6605014	IG402 02206000	22x3/4"	NR	1	01	

GOMITO A 90° F/FILETTO F



codice	sigla	Ø	UM	min. ord. conf.	cat.	prezzo (€)
6606001	IG403 01003000	10x3/8"	NR	1	01	
6606002	IG403 01004000	10x1/2"	NR	1	01	
6606003	IG403 01203000	12x3/8"	NR	1	01	
6606004	IG403 01204000	12x1/2"	NR	1	01	
6606006	IG403 01404000	14x1/2"	NR	1	01	
6606009	IG403 01604000	16x1/2"	NR	1	01	
6606010	IG403 01606000	16x3/4"	NR	1	01	
6606011	IG403 01804000	18x1/2"	NR	1	01	
6606012	IG403 01806000	18x3/4"	NR	1	01	
6606014	IG403 02206000	22x3/4"	NR	1	01	
6606015	IG403 02208000	22x1"	NR	1	01	
6606017	IG403 02808000	28x1"	NR	1	01	

GOMITO A 90° F/FILETTO F, CON FLANGIA A 3 FORI DI FISSAGGIO



codice	sigla	Ø	UM	min. ord. conf.	cat.	prezzo (€)
6607001	IG403L01004000	10x1/2"	NR	1	01	
6607002	IG403L01204000	12x1/2"	NR	1	01	
6607003	IG403L01404000	14x1/2"	NR	1	01	
6607004	IG403L01604000	16x1/2"	NR	1	01	

TEE F/F/F



codice	sigla	Ø	UM	min. ord. conf.	cat.	prezzo (€)
6608001	IG601 01000000	10	NR	1	01	
6608002	IG601 01200000	12	NR	1	01	
6608003	IG601 01400000	14	NR	1	01	
6608004	IG601 01600000	16	NR	1	01	
6608005	IG601 01800000	18	NR	1	01	
6608006	IG601 02200000	22	NR	1	01	

TEE F / FILETTO F/F



codice	sigla	Ø	UM	min. ord. conf.	cat.	prezzo (€)
6609002	IG617 01004000	10x1/2"	NR	1	01	
6609004	IG617 01204000	12x1/2"	NR	1	01	
6609005	IG617 01404000	14x1/2"	NR	1	01	
6609006	IG617 01604000	16x1/2"	NR	1	01	
6609008	IG617 01804000	18x1/2"	NR	1	01	
6609011	IG617 02206000	22x3/4"	NR	1	01	

SARACINESCA PN 16

Corpo in ottone, volantino in acciaio.
Attacchi femmina.
Temperatura d'esercizio: 0°C / +100°C

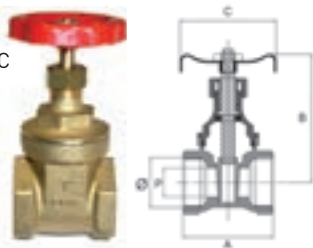

codice	Ø	A	B	C	P	UM	min. ord.	conf.	cat.	prezzo (€)
● 1529001	1/2"	38	68	45	15	NR	15	15	21	
● 1529002	3/4"	44	78	50	19	NR	15	15	21	
● 1529003	1"	48	91	55	24	NR	10	10	21	
● 1529004	1"1/4	51	108	60	32	NR	1	4	21	
● 1529005	1"1/2	58	125	70	37	NR	1	2	21	
● 1529006	2"	63	143	80	47	NR	1	2	21	
● 1529007	2"1/2	64	175	100	60	NR	1	1	21	
● 1529008	3"	74	200	100	72	NR	1	1	21	

VALVOLE DI RITEGNO PASSAGGIO TOTALE, F/F

Molla in acciaio inox AISI 302, guarnizione in NBR, otturatore in FORTRON (PPS) un tecnopolimero semi-cristallino caricato con fibra di vetro (elevata resistenza meccanica, chimica, e alle alte temperature). Temperatura d'esercizio: -20°C / +100°C



codice	Ø	PN	A	B	C	UM	min. ord.	conf.	cat.	prezzo (€)
● 1911001	3/8"	40	47	27	21	NR	1	40	02	
● 1911002	1/2"	40	59	34,5	26	NR	30	30	02	
● 1911003	3/4"	40	65	42	32	NR	20	20	02	
● 1911004	1"	25	75	49	39	NR	16	16	02	
● 1911005	1"1/4	25	83,5	61	49	NR	1	36	02	
● 1911006	1"1/2	16	89	73	55	NR	1	24	02	
● 1911007	2"	16	101,5	87,5	68	NR	1	12	02	
● 1911008	2"1/2	12	121	111,5	83	NR	1	2	02	
● 1911009	3"	12	136	133	98	NR	1	2	02	

VALVOLA DI FONDO

Corpo e filtro in ottone, otturatore in ottone con guarnizione SBR
Temperatura d'esercizio: 0°C / +90°C



codice	Ø	PN	A	B	UM	min. ord.	conf.	cat.	prezzo (€)
● 1914002	3/4"	10	45	73	NR	1	20	21	
● 1914003	1"	10	51	81	NR	1	15	21	
● 1914004	1"1/4	8	61	95	NR	1	6	21	
● 1914005	1"1/2	8	68	103	NR	1	5	21	
● 1914006	2"	8	80	121	NR	1	4	21	

VALVOLA DI FONDO TUBOLARE

Corpo e filtro in ottone, otturatore in ottone con guarnizione SBR e rondella in acciaio inox AISI 304
Temperatura d'esercizio: 0°C / +90°C



codice	Ø	PN	A	B	UM	min. ord.	conf.	cat.	prezzo (€)
● 1913002	3/4"	10	30	100	NR	1	20	21	
● 1913003	1"	10	39	114	NR	1	15	21	
● 1913004	1"1/4	8	46	127	NR	1	10	21	

FILTRO VALVOLA DI RITEGNO

Filtro in acciaio inox AISI 304, raccordo maschio in nylon
Temperatura d'esercizio: 0°C / +110°C



codice	Ø	A	B	C	D	UM	min. ord.	conf.	cat.	prezzo (€)
● 1912003	3/4"	33	56	29	42	NR	10	10	09	
● 1912004	1"	41	58	36	43	NR	10	10	09	
● 1912005	1"1/4	50	69	44	53	NR	1	10	09	
● 1912006	1"1/2	55	78	49	62	NR	1	10	09	
● 1912007	2"	67	96	61	79	NR	1	10	09	
● 1912008	2"1/2	86	98	80	76	NR	1	10	09	

FILTRO RACCOGLI IMPURITÀ PN20

Corpo e tappo d'ispezione in ottone, filtro acciaio inox AISI 302. Attacchi femmina
Temperatura d'esercizio: 0°C / +80°C

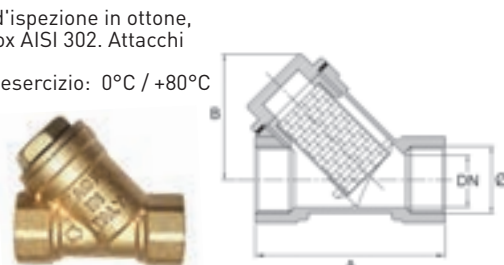

codice	Ø	A	B	DN	filtraggio	UM	min. ord.	conf.	cat.	prezzo (€)
● 1530001	1/2"	58	40	15	500µ	NR	20	20	21	
● 1530002	3/4"	70	50	20	500µ	NR	12	12	21	
● 1530003	1"	75	60	25	500µ	NR	12	12	21	
● 1530004	1"1/4	96	68	32	500µ	NR	1	4	21	
● 1530005	1"1/2	106	75	40	500µ	NR	1	3	21	
● 1530006	2"	126	90	50	500µ	NR	1	2	21	
● 1530009	2"1/2	146	100	65	1000µ	NR	1	1	21	

RACCORDERIA IN OTTONE

VALVOLE

VALVOLA CLAPET SEDE GOMMA

Corpo e tappo in ottone, otturatore in ottone con guarnizione NBR
Temperatura d'esercizio: 0°C / +100°C

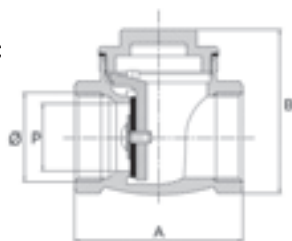

codice	Ø	PN	A	B	P	UM	min. ord.	conf.	cat.	prezzo (€)
● 1531101	1/2"	10	47	46	15	NR	20	20	21	
● 1531102	3/4"	10	53	51	20	NR	15	15	21	
● 1531103	1"	10	63	61	25	NR	10	10	21	
● 1531104	1"1/4	10	74	73	33	NR	1	8	21	
● 1531105	1"1/2	10	87	85	37	NR	1	6	21	
● 1531106	2"	10	97	94	47	NR	1	3	21	
● 1531107	2"1/2	6	118	107	55	NR	1	1	21	
● 1531108	3"	6	135	130	70	NR	1	1	21	

RACCORDO A 5 VIE

Attacchi 1/4"
Altezza 72 mm



codice	Ø	UM	min. ord.	conf.	cat.	prezzo (€)
● 1536001	1"	NR	1	10	21	

RACCORDI PER TUBO FERRO

Raccordo per tubo ferro a tenuta metallica, con anello conico inox AISI 303. Temperatura d'esercizio da - 20° a + 120°C

TUBOFIX MASCHIO



codice	Ø	UM	min. ord.	conf.	cat.	prezzo (€)
● 1540000	3/8"	NR	24	24	04	
● 1540001	1/2"	NR	24	24	04	
● 1540002	3/4"	NR	24	24	04	
● 1540003	1"	NR	12	12	04	
● 1540004	1"1/4	NR	1	12	04	
● 1540005	1"1/2	NR	1	6	04	
● 1540006	2"	NR	1	4	04	

TUBOFIX FEMMINA



codice	Ø	UM	min. ord.	conf.	cat.	prezzo (€)
● 1541007	3/8"	NR	24	24	04	
● 1541001	1/2"	NR	24	24	04	
● 1541002	3/4"	NR	24	24	04	
● 1541003	1"	NR	12	12	04	
● 1541004	1"1/4	NR	1	12	04	
● 1541005	1"1/2	NR	1	6	04	
● 1541006	2"	NR	1	4	04	

RACCORDERIA IN RAME-BRONZO

RACCORDERIA A BRASARE IN RAME

Conforme alle norme:

- UNI EN 1254-1; UNI EN 1254-4; UNI EN 1254-5
- I terminali filettati sono realizzati in accordo alla norma UNI EN 10226-1 e UNI EN ISO 228-1.
- Campi applicazione: acqua sanitaria, riscaldamento, aria condizionata e refrigerazione.

CURVA A 90° M/F



codice	sigla	Ø	UM	min. ord. conf.	cat.	prezzo (€)
6200003	5001A010000000	10	NR	10	07	
6200004	5001A012000000	12	NR	10	07	
6200005	5001A014000000	14	NR	10	07	
6200007	5001A016000000	16	NR	10	07	
6200008	5001A018000000	18	NR	10	07	
6200010	5001A022000000	22	NR	10	07	
6200012	5001A028000000	28	NR	10	07	
6200014	5001A035000000	35	NR	2	07	
6200016	5001A042000000	42	NR	2	07	
6200018	5001A054000000	54	NR	1	07	

CURVA A 90° F/F



codice	sigla	Ø	UM	min. ord. conf.	cat.	prezzo (€)
6201003	5002A010000000	10	NR	10	07	
6201004	5002A012000000	12	NR	10	07	
6201005	5002A014000000	14	NR	10	07	
6201007	5002A016000000	16	NR	10	07	
6201008	5002A018000000	18	NR	10	07	
6201010	5002A022000000	22	NR	10	07	
6201012	5002A028000000	28	NR	10	07	
6201014	5002A035000000	35	NR	2	07	
6201016	5002A042000000	42	NR	2	07	
6201018	5002A054000000	54	NR	2	07	

CURVA A 90° F, CON DADO FOLLE A SEDE PIANA



codice	sigla	Ø	UM	min. ord. conf.	cat.	prezzo (€)
6202002	5002G01200400P	12-1/2"	NR	25	07	
6202003	5002G01400400P	14-1/2"	NR	25	07	
6202006	5002G01600400P	16-1/2"	NR	25	07	
6202007	5002G01600600P	16-3/4"	NR	25	07	
6202008	5002G01800600P	18-3/4"	NR	25	07	
6202009	5002G02200600P	22-3/4"	NR	25	07	

CURVA A 45° M/F



codice	sigla	Ø	UM	min. ord. conf.	cat.	prezzo (€)
6203002	5040 010000000	10	NR	10	07	
6203003	5040 012000000	12	NR	10	07	
6203004	5040 014000000	14	NR	10	07	
6203006	5040 016000000	16	NR	10	07	
6203007	5040 018000000	18	NR	10	07	
6203009	5040 022000000	22	NR	10	07	
6203011	5040 028000000	28	NR	10	07	
6203013	5040 035000000	35	NR	2	07	
6203015	5040 042000000	42	NR	2	07	
6203017	5040 054000000	54	NR	2	07	

CURVA A 45° F/F



codice	sigla	Ø	UM	min. ord. conf.	cat.	prezzo (€)
6204003	5041 010000000	10	NR	10	07	
6204004	5041 012000000	12	NR	10	07	
6204005	5041 014000000	14	NR	10	07	
6204007	5041 016000000	16	NR	10	07	
6204008	5041 018000000	18	NR	10	07	
6204010	5041 022000000	22	NR	10	07	
6204012	5041 028000000	28	NR	10	07	
6204014	5041 035000000	35	NR	2	07	
6204016	5041 042000000	42	NR	2	07	
6204018	5041 054000000	54	NR	2	07	

RACCORDERIA IN RAME-BRONZO

RACCORDERIA A BRASARE IN RAME

SORPASSO F/F



codice	sigla	∅	UM	min. ord. conf.	cat.	prezzo (€)
6206002	5085 014000000	14	NR	10	07	
6206004	5085 016000000	16	NR	10	07	
6206005	5085 018000000	18	NR	10	07	
6206006	5085 022000000	22	NR	10	07	

SORPASSO M/F



codice	sigla	∅	UM	min. ord. conf.	cat.	prezzo (€)
6207002	5086 014000000	14	NR	10	07	
6207004	5086 016000000	16	NR	10	07	
6207005	5086 018000000	18	NR	10	07	
6207006	5086 022000000	22	NR	10	07	

GOMITO A 90° F/F



codice	sigla	∅	UM	min. ord. conf.	cat.	prezzo (€)
6208003	5090 010000000	10	NR	10	07	
6208004	5090 012000000	12	NR	10	07	
6208005	5090 014000000	14	NR	10	07	
6208007	5090 016000000	16	NR	10	07	
6208008	5090 018000000	18	NR	10	07	
6208010	5090 022000000	22	NR	10	07	
6208012	5090 028000000	28	NR	10	07	
6208014	5090 035000000	35	NR	2	07	
6208016	5090 042000000	42	NR	2	07	
6208018	5090 054000000	54	NR	1	07	

TEE F/F/F

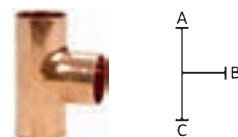

codice	sigla	A - B - C	UM	min. ord. conf.	cat.	prezzo (€)
6211003	5130 010010010	10-10-10	NR	10	07	
6211004	5130 012012012	12-12-12	NR	10	07	
6211005	5130 014014014	14-14-14	NR	10	07	
6211007	5130 016016016	16-16-16	NR	10	07	
6211008	5130 018018018	18-18-18	NR	10	07	
6211009	5130 022022022	22-22-22	NR	10	07	
6211012	5130 028028028	28-28-28	NR	10	07	
6211013	5130 035035035	35-35-35	NR	2	07	
6211014	5130 042042042	42-42-42	NR	2	07	
6211016	5130 054054054	54-54-54	NR	1	07	

GOMITO A 90° M/F



codice	sigla	∅	UM	min. ord. conf.	cat.	prezzo (€)
6210003	5092 010000000	10	NR	10	07	
6210004	5092 012000000	12	NR	10	07	
6210005	5092 014000000	14	NR	10	07	
6210007	5092 016000000	16	NR	10	07	
6210008	5092 018000000	18	NR	10	07	
6210010	5092 022000000	22	NR	10	07	
6210012	5092 028000000	28	NR	10	07	
6210014	5092 035000000	35	NR	2	07	
6210016	5092 042000000	42	NR	2	07	
6210018	5092 054000000	54	NR	1	07	

RACCORDERIA IN RAME-BRONZO

RACCORDERIA A BRASARE IN RAME

TEE RIDOTTO F/F/F

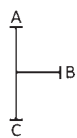

codice	sigla	A - B - C	UM	min. ord. conf.	cat.	prezzo (€)
6212025	5130 014012012	14-12-12	NR	10	07	
6212026	5130 014012014	14-12-14	NR	10	07	
6212048	5130 016012012	16-12-12	NR	10	07	
6212050	5130 016012016	16-12-16	NR	10	07	
6212052	5130 016014014	16-14-14	NR	10	07	
6212053	5130 016014016	16-14-16	NR	10	07	
6212061	5130 018012012	18-12-12	NR	10	07	
6212065	5130 018012018	18-12-18	NR	10	07	
6212067	5130 018014014	18-14-14	NR	10	07	
6212068	5130 018014016	18-14-16	NR	10	07	
6212069	5130 018014018	18-14-18	NR	10	07	
6212074	5130 018016016	18-16-16	NR	10	07	
6212075	5130 018016018	18-16-18	NR	10	07	
6212077	5130 018018014	18-18-14	NR	10	07	
6212081	5130 018022018	18-22-18	NR	10	07	
6212088	5130 022012022	22-12-22	NR	10	07	
6212089	5130 022014014	22-14-14	NR	10	07	
6212091	5130 022014018	22-14-18	NR	10	07	
6212092	5130 022014022	22-14-22	NR	10	07	
6212098	5130 022016016	22-16-16	NR	10	07	
6212099	5130 022016018	22-16-18	NR	10	07	
6212100	5130 022016022	22-16-22	NR	10	07	
6212101	5130 022018014	22-18-14	NR	10	07	
6212104	5130 022018018	22-18-18	NR	10	07	
6212105	5130 022018022	22-18-22	NR	10	07	
6212107	5130 022022014	22-22-14	NR	10	07	
6212110	5130 022022018	22-22-18	NR	10	07	
6212111	5130 022028022	22-28-22	NR	10	07	
6212112	5130 028012028	28-12-28	NR	10	07	
6212113	5130 028014028	28-14-28	NR	10	07	
6212119	5130 028016028	28-16-28	NR	10	07	
6212123	5130 028018028	28-18-28	NR	10	07	
6212127	5130 028022022	28-22-22	NR	10	07	
6212128	5130 028022028	28-22-28	NR	10	07	
6212133	5130 028028022	28-28-22	NR	10	07	
6212143	5130 035022035	35-22-35	NR	2	07	
6212147	5130 035028035	35-28-35	NR	2	07	

MANICOTTO RIDOTTO F/F



codice	sigla	Ø	UM	min. ord. conf.	cat.	prezzo (€)
6222006	5240 014010000	14-10	NR	10	07	
6222007	5240 014012000	14-12	NR	10	07	
6222013	5240 016012000	16-12	NR	10	07	
6222014	5240 016014000	16-14	NR	10	07	
6222016	5240 018010000	18-10	NR	10	07	
6222017	5240 018012000	18-12	NR	10	07	
6222018	5240 018014000	18-14	NR	10	07	
6222020	5240 018016000	18-16	NR	10	07	
6222022	5240 022014000	22-14	NR	10	07	
6222024	5240 022016000	22-16	NR	10	07	
6222025	5240 022018000	22-18	NR	10	07	
6222032	5240 028018000	28-18	NR	10	07	
6222033	5240 028022000	28-22	NR	10	07	
6222041	5240 035022000	35-22	NR	2	07	
6222042	5240 035028000	35-28	NR	2	07	
6222050	5240 042035000	42-35	NR	2	07	

MANICOTTO RIDOTTO M/F



codice	sigla	Ø	UM	min. ord. conf.	cat.	prezzo (€)
6224006	5243 012010000	12-10	NR	10	07	
6224007	5243 014010000	14-10	NR	10	07	
6224008	5243 014012000	14-12	NR	10	07	
6224014	5243 016012000	16-12	NR	10	07	
6224015	5243 016014000	16-14	NR	10	07	
6224017	5243 018012000	18-12	NR	10	07	
6224018	5243 018014000	18-14	NR	10	07	
6224020	5243 018016000	18-16	NR	10	07	
6224022	5243 022012000	22-12	NR	10	07	
6224023	5243 022014000	22-14	NR	10	07	
6224025	5243 022016000	22-16	NR	10	07	
6224026	5243 022018000	22-18	NR	10	07	
6224031	5243 028012000	28-12	NR	10	07	
6224032	5243 028014000	28-14	NR	10	07	
6224034	5243 028016000	28-16	NR	10	07	
6224035	5243 028018000	28-18	NR	10	07	
6224036	5243 028022000	28-22	NR	10	07	
6224041	5243 035022000	35-22	NR	2	07	
6224042	5243 035028000	35-28	NR	2	07	
6224046	5243 042022000	42-22	NR	1	07	
6224047	5243 042028000	42-28	NR	2	07	
6224048	5243 042035000	42-35	NR	2	07	
6224052	5243 054028000	54-28	NR	1	07	
6224053	5243 054035000	54-35	NR	2	07	
6224054	5243 054042000	54-42	NR	2	07	

RACCORDERIA IN RAME-BRONZO

RACCORDERIA A BRASARE IN RAME

MANICOTTO CON BATTUTA F/F



codice	sigla	∅	UM	min. ord. conf.	cat.	prezzo (€)
6226002	5270 008000000	8	NR	10	07	
6226003	5270 010000000	10	NR	10	07	
6226004	5270 012000000	12	NR	10	07	
6226005	5270 014000000	14	NR	10	07	
6226007	5270 016000000	16	NR	10	07	
6226008	5270 018000000	18	NR	10	07	
6226010	5270 022000000	22	NR	10	07	
6226012	5270 028000000	28	NR	10	07	
6226014	5270 035000000	35	NR	10	07	
6226016	5270 042000000	42	NR	2	07	
6226017	5270 054000000	54	NR	2	07	

CALOTTA F



codice	sigla	∅	UM	min. ord. conf.	cat.	prezzo (€)
6229003	5301 010000000	10	NR	10	07	
6229004	5301 012000000	12	NR	10	07	
6229005	5301 014000000	14	NR	10	07	
6229007	5301 016000000	16	NR	10	07	
6229008	5301 018000000	18	NR	10	07	
6229009	5301 022000000	22	NR	10	07	
6229010	5301 028000000	28	NR	10	07	
6229011	5301 035000000	35	NR	1	07	
6229012	5301 042000000	42	NR	1	07	
6229013	5301 054000000	54	NR	1	07	

CODOLO F, CON DADO FOLLE E SEDE PIANA



codice	sigla	∅	UM	min. ord. conf.	cat.	prezzo (€)
6231003	5359G01200400P	12-1/2"	NR	25	07	
6231004	5359G01400400P	14-1/2"	NR	25	07	
6231005	5359G01400600P	14-3/4"	NR	25	07	
6231006	5359G01600400P	16-1/2"	NR	25	07	
6231007	5359G01600600P	16-3/4"	NR	25	07	
6231008	5359G01800600P	18-3/4"	NR	25	07	
6231009	5359G02200600P	22-3/4"	NR	25	07	
6231010	5359G02200800P	22-1"	NR	10	07	

RACCORDERIA IN RAME-BRONZO

RACCORDERIA A BRASARE ED AVVITARE IN BRONZO

Conforme alle norme:

- UNI EN 1254-1; UNI EN 1254-4; UNI EN 1254-5
- I terminali filettati sono realizzati in accordo alla norma UNI EN 10226-1 e UNI ISO 228-1.
- Campi applicazione: acqua sanitaria, riscaldamento, aria condizionata e refrigerazione.

GOMITO A 90° F/FILETTO F



codice	sigla	Ø	UM	min. ord. conf.	cat.	prezzo (€)
6402005	4090G012004000	12x1/2"	NR	10	02	
6402007	4090G014004000	14x1/2"	NR	10	02	
6402013	4090G016004000	16x1/2"	NR	10	02	
6402015	4090G018004000	18x1/2"	NR	10	02	
6402016	4090G018006000	18x3/4"	NR	10	02	
6402017	4090G022004000	22x1/2"	NR	10	02	
6402018	4090G022006000	22x3/4"	NR	10	02	
6402019	4090G022008000	22x1"	NR	10	02	
6402020	4090G028006000	28x3/4"	NR	10	02	
6402021	4090G028008000	28x1"	NR	10	02	
6402022	4090G035008000	35x1"	NR	1	02	
6402023	4090G035010000	35x1"1/4	NR	1	02	

GOMITO A 90° F/FILETTO M



codice	sigla	Ø	UM	min. ord. conf.	cat.	prezzo (€)
6403006	4092G012004000	12x1/2"	NR	10	02	
6403007	4092G014003000	14x3/8"	NR	10	02	
6403008	4092G014004000	14x1/2"	NR	10	02	
6403012	4092G016004000	16x1/2"	NR	10	02	
6403014	4092G018004000	18x1/2"	NR	10	02	
6403015	4092G018006000	18x3/4"	NR	10	02	
6403016	4092G022004000	22x1/2"	NR	10	02	
6403017	4092G022006000	22x3/4"	NR	10	02	
6403020	4092G028008000	28x1"	NR	10	02	
6403021	4092G035010000	35x1"1/4	NR	1	02	

MANICOTTO F/FILETTO M



codice	sigla	Ø	UM	min. ord. conf.	cat.	prezzo (€)
6410004	4243G010003000	10x3/8"	NR	10	02	
6410005	4243G010004000	10x1/2"	NR	10	02	
6410007	4243G012003000	12x3/8"	NR	10	02	
6410008	4243G012004000	12x1/2"	NR	10	02	
6410009	4243G014003000	14x3/8"	NR	10	02	
6410010	4243G014004000	14x1/2"	NR	10	02	
6410011	4243G014006000	14x3/4"	NR	10	02	
6410016	4243G016004000	16x1/2"	NR	10	02	
6410017	4243G016006000	16x3/4"	NR	10	02	
6410018	4243G018004000	18x1/2"	NR	10	02	
6410019	4243G018006000	18x3/4"	NR	10	02	
6410020	4243G022004000	22x1/2"	NR	10	02	
6410021	4243G022006000	22x3/4"	NR	10	02	
6410022	4243G022008000	22x1"	NR	10	02	
6410024	4243G028006000	28x3/4"	NR	10	02	
6410025	4243G028008000	28x1"	NR	10	02	
6410026	4243G028010000	28x1"1/4	NR	1	02	
6410027	4243G035008000	35x1"	NR	1	02	
6410028	4243G035010000	35x1"1/4	NR	10	02	
6410030	4243G042010000	42x1"1/4	NR	1	02	
6410031	4243G042012000	42x1"1/2	NR	1	02	
6410033	4243G054012000	54x1"1/2	NR	1	02	
6410034	4243G054016000	54x2"	NR	1	02	

BOCCHETT. A 90° F/FILETTO M, A TENUTA METALL.



codice	sigla	Ø	UM	min. ord. conf.	cat.	prezzo (€)
6406012	4098G018006000	18x3/4"	NR	10	02	
6406013	4098G022006000	22x3/4"	NR	10	02	

TEE F FILETTO F/F



codice	sigla	Ø	UM	min. ord. conf.	cat.	prezzo (€)
6407004	4130G012004012	12x1/2"x12	NR	10	02	
6407006	4130G014004014	14x1/2"x14	NR	10	02	
6407011	4130G016004016	16x1/2"x16	NR	10	02	
6407014	4130G018004018	18x1/2"x18	NR	10	02	
6407015	4130G018006018	18x3/4"x18	NR	10	02	
6407017	4130G022004022	22x1/2"x22	NR	10	02	
6407018	4130G022006022	22x3/4"x22	NR	10	02	
6407019	4130G028004028	28x1/2"x28	NR	10	02	
6407020	4130G028006028	28x3/4"x28	NR	10	02	
6407021	4130G028008028	28x1"x28	NR	10	02	

RACCORDERIA IN RAME-BRONZO

RACCORDERIA A BRASARE ED AVVITARE IN BRONZO

MANICOTTO F/FILETTO F



codice	sigla	Ø	UM	min. ord. conf.	cat.	prezzo (€)
6412004	4270G010004000	10x1/2"	NR	10	02	
6412005	4270G012003000	12x3/8"	NR	10	02	
6412006	4270G012004000	12x1/2"	NR	10	02	
6412007	4270G014003000	14x3/8"	NR	10	02	
6412008	4270G014004000	14x1/2"	NR	10	02	
6412014	4270G016004000	16x1/2"	NR	10	02	
6412015	4270G016006000	16x3/4"	NR	10	02	
6412016	4270G018004000	18x1/2"	NR	10	02	
6412017	4270G018006000	18x3/4"	NR	10	02	
6412018	4270G022004000	22x1/2"	NR	10	02	
6412019	4270G022006000	22x3/4"	NR	10	02	
6412020	4270G022008000	22x1"	NR	10	02	
6412022	4270G028006000	28x3/4"	NR	10	02	
6412023	4270G028008000	28x1"	NR	10	02	
6412026	4270G035008000	35x1"	NR	1	02	
6412027	4270G035010000	35x1"1/4	NR	1	02	
6412029	4270G042010000	42x1"1/4	NR	1	02	
6412030	4270G042012000	42x1"1/2	NR	1	02	
6412031	4270G054012000	54x1"1/2	NR	1	02	
6412032	4270G054016000	54x2"	NR	1	02	

BOCCHETTONE F/FILETTO F, A TENUTA METALLICA



codice	sigla	Ø	UM	min. ord. conf.	cat.	prezzo (€)
6419011	4340G016004000	16x1/2"	NR	10	02	
6419014	4340G018006000	18x3/4"	NR	10	02	
6419015	4340G022006000	22x3/4"	NR	10	02	
6419016	4340G022008000	22x1"	NR	10	02	
6419017	4340G028006000	28x3/4"	NR	10	02	
6419018	4340G028008000	28x1"	NR	10	02	

BOCCHETTONE F/FILETTO M, A TENUTA METALLICA



codice	sigla	Ø	UM	min. ord. conf.	cat.	prezzo (€)
6420005	4341G014004000	14x1/2"	NR	10	02	
6420010	4341G016004000	16x1/2"	NR	10	02	
6420011	4341G016006000	16x3/4"	NR	10	02	
6420012	4341G018004000	18x1/2"	NR	10	02	
6420013	4341G018006000	18x3/4"	NR	10	02	
6420014	4341G022004000	22x1/2"	NR	10	02	
6420015	4341G022006000	22x3/4"	NR	10	02	
6420016	4341G022008000	22x1"	NR	10	02	
6420017	4341G028008000	28x1"	NR	10	02	
6420018	4341G035010000	35x1"1/4	NR	1	02	

BOCCHETTONE F/FILETTO M SEDE PIANA C/GUARNIZIONE

Solo per acqua



codice	sigla	Ø	UM	min. ord. conf.	cat.	prezzo (€)
6417008	4331G022006000	22x3/4"	NR	10	02	
6417009	4331G028008000	35x1"1/4	NR	10	02	

GOMITO A 90° F/FILETTO F, C/FLANGIA A 3 FORI DI FISSAGGIO



codice	sigla	Ø	UM	min. ord. conf.	cat.	prezzo (€)
6430004	4471G012004000	12x1/2"	NR	10	02	
6430006	4471G014004000	14x1/2"	NR	10	02	
6430009	4471G016004000	16x1/2"	NR	10	02	

GOMITO A 90° F/FILETTO F, C/FLANGIA A 2 FORI DI FISSAGGIO



codice	sigla	Ø	UM	min. ord. conf.	cat.	prezzo (€)
6431002	4472G012004000	12x1/2"	NR	10	02	
6431004	4472G014004000	14x1/2"	NR	10	02	
6431009	4472G016004000	16x1/2"	NR	10	02	
6431010	4472G018004000	18x1/2"	NR	10	02	
6431011	4472G022006000	22x3/4"	NR	10	02	

RACCORDERIA IN RAME-BRONZO

RACCORDERIA A PRESSARE RAME ACQUA



Conforme alla norma UNI 11065

Elastomero in EPDM per l'acqua (UNI EN 681-1)

- Misure disponibili profilo "V": 12-54 (mm.)
- Misure disponibili profilo "XL": 64-108 (mm.).

La raccorderia a pressare per acqua è utilizzabile nelle installazioni per il trasporto e distribuzione di acque destinate al consumo umano, nell'impiantistica civile e industriale.

CURVA A 90° F/F



codice	sigla	Ø	UM	min. ord. conf.	cat.	prezzo (€)
6638001	P5002 01200000	12	NR	10	01	
6638002	P5002 01500000	15	NR	10	01	
6638003	P5002 01800000	18	NR	10	01	
6638004	P5002 02200000	22	NR	10	01	
6638005	P5002 02800000	28	NR	5	01	
6638006	P5002 03500000	35	NR	5	01	
6638007	P5002 04200000	42	NR	5	01	
6638008	P5002 05400000	54	NR	1	01	

CURVA A 90° M/F



codice	sigla	Ø	UM	min. ord. conf.	cat.	prezzo (€)
6637001	P5001 01200000	12	NR	10	01	
6637002	P5001 01500000	15	NR	10	01	
6637003	P5001 01800000	18	NR	10	01	
6637004	P5001 02200000	22	NR	10	01	
6637005	P5001 02800000	28	NR	5	01	
6637006	P5001 03500000	35	NR	5	01	
6637007	P5001 04200000	42	NR	5	01	
6637008	P5001 05400000	54	NR	1	01	

CURVA A 45° F/F



codice	sigla	Ø	UM	min. ord. conf.	cat.	prezzo (€)
6640001	P5041 01200000	12	NR	10	01	
6640002	P5041 01500000	15	NR	10	01	
6640003	P5041 01800000	18	NR	10	01	
6640004	P5041 02200000	22	NR	10	01	
6640005	P5041 02800000	28	NR	5	01	
6640006	P5041 03500000	35	NR	5	01	
6640007	P5041 04200000	42	NR	5	01	
6640008	P5041 05400000	54	NR	1	01	

CURVA A 45° M/F



codice	sigla	Ø	UM	min. ord. conf.	cat.	prezzo (€)
6639001	P5040 01200000	12	NR	10	01	
6639002	P5040 01500000	15	NR	10	01	
6639003	P5040 01800000	18	NR	10	01	
6639004	P5040 02200000	22	NR	10	01	
6639005	P5040 02800000	28	NR	5	01	
6639006	P5040 03500000	35	NR	5	01	
6639007	P5040 04200000	42	NR	5	01	
6639008	P5040 05400000	54	NR	1	01	

TEE F/F/F



codice	sigla	Ø	UM	min. ord. conf.	cat.	prezzo (€)
6643001	P5130 01212012	12	NR	10	01	
6643006	P5130 01515015	15	NR	10	01	
6643013	P5130 01818018	18	NR	10	01	
6643024	P5130 02222022	22	NR	10	01	
6643035	P5130 02828028	28	NR	5	01	
6643042	P5130 03535035	35	NR	1	01	
6643047	P5130 04242042	42	NR	1	01	
6643053	P5130 05454054	54	NR	1	01	

RACCORDERIA IN RAME-BRONZO

RACCORDERIA A PRESSARE RAME ACQUA

TEE RIDOTTO F/F/F



codice	sigla	Ø	UM	min. ord. conf.	cat.	prezzo (€)
6643004	P5130 01512015	15-12-15	NR	10	01	
6643005	P5130 01515012	15-15-12	NR	5	01	
6643009	P5130 01812018	18-12-18	NR	5	01	
6643011	P5130 01815018	18-15-18	NR	10	01	
6643015	P5130 02212022	22-12-22	NR	10	01	
6643018	P5130 02215022	22-15-22	NR	5	01	
6643021	P5130 02218022	22-18-22	NR	5	01	
6643027	P5130 02815028	28-15-28	NR	5	01	
6643029	P5130 02818028	28-18-28	NR	5	01	
6643030	P5130 02822022	28-22-22	NR	5	01	
6643031	P5130 02822028	28-22-28	NR	5	01	
6643037	P5130 03518035	35-18-35	NR	1	01	
6643039	P5130 03522035	35-22-35	NR	1	01	
6643041	P5130 03528035	35-28-35	NR	1	01	
6643043	P5130 04222042	42-22-42	NR	1	01	
6643044	P5130 04228042	42-28-42	NR	1	01	
6643046	P5130 04235042	42-35-42	NR	1	01	
6643048	P5130 05422054	54-22-54	NR	1	01	
6643049	P5130 05428054	54-28-54	NR	1	01	
6643050	P5130 05435054	54-35-54	NR	1	01	

MANICOTTO RIDOTTO M/F



codice	sigla	Ø	UM	min. ord. conf.	cat.	prezzo (€)
6645001	P5243 01512000	15x12	NR	10	01	
6645002	P5243 01812000	18x12	NR	10	01	
6645003	P5243 01815000	18x15	NR	10	01	
6645004	P5243 02215000	22x15	NR	10	01	
6645005	P5243 02218000	22x18	NR	10	01	
6645006	P5243 02815000	28x15	NR	5	01	
6645007	P5243 02818000	28x18	NR	10	01	
6645008	P5243 02822000	28x22	NR	10	01	
6645009	P5243 03522000	35x22	NR	5	01	
6645010	P5243 03528000	35x28	NR	1	01	
6645011	P5243 04222000	42x22	NR	1	01	
6645012	P5243 04228000	42x28	NR	1	01	
6645013	P5243 04235000	42x35	NR	1	01	
6645014	P5243 05435000	54x35	NR	1	01	
6645015	P5243 05442000	54x42	NR	1	01	

MANICOTTO RIDOTTO F/F



codice	sigla	Ø	UM	min. ord. conf.	cat.	prezzo (€)
6644001	P5240 01512000	15x12	NR	10	01	
6644002	P5240 01815000	18x15	NR	10	01	
6644003	P5240 02215000	22x15	NR	10	01	
6644004	P5240 02218000	22x18	NR	10	01	
6644005	P5240 02822000	28x22	NR	5	01	
6644006	P5240 03528000	35x28	NR	5	01	
6644007	P5240 04235000	42x35	NR	1	01	
6644008	P5240 05442000	54x42	NR	1	01	

MANICOTTO CON BATTUTA F/F



codice	sigla	Ø	UM	min. ord. conf.	cat.	prezzo (€)
6646001	P5270 01200000	12	NR	10	01	
6646002	P5270 01500000	15	NR	10	01	
6646003	P5270 01800000	18	NR	10	01	
6646004	P5270 02200000	22	NR	10	01	
6646005	P5270 02800000	28	NR	5	01	
6646006	P5270 03500000	35	NR	1	01	
6646007	P5270 04200000	42	NR	1	01	
6646008	P5270 05400000	54	NR	1	01	

TAPPO DI CHIUSURA F



codice	sigla	Ø	UM	min. ord. conf.	cat.	prezzo (€)
6648001	P5301 01200000	12	NR	10	01	
6648002	P5301 01500000	15	NR	10	01	
6648003	P5301 01800000	18	NR	10	01	
6648004	P5301 02200000	22	NR	10	01	
6648005	P5301 02800000	28	NR	5	01	
6648006	P5301 03500000	35	NR	1	01	
6648007	P5301 04200000	42	NR	1	01	
6648008	P5301 05400000	54	NR	1	01	

RACCORDERIA IN RAME-BRONZO

RACCORDERIA A PRESSARE BRONZO ACQUA



Conforme alle norme UNI 11065, UNI CIG 7129

Elastomero in EPDM per l'acqua (UNI EN 681-1)

- Misure disponibili profilo "V": 12-54 (mm.)
- Misure disponibili profilo "XL": 64-108 (mm.)

La raccorderia a pressione per acqua è utilizzabile nelle installazioni per il trasporto e distribuzione di acque destinate al consumo umano, nell'impiantistica civile, industriale e navale.

CURVA A 90° F/FILETTO M



codice	sigla	Ø	UM	min. ord. conf.	cat.	prezzo (€)
662002	P4001G01204000	12x1/2"	NR	5	01	
662004	P4001G01504000	15x1/2"	NR	10	01	
662005	P4001G01804000	18x1/2"	NR	5	01	
662007	P4001G02206000	22x3/4"	NR	5	01	
662008	P4001G02808000	28x1"	NR	5	01	

GOMITO A 90° F/FILETTO F



codice	sigla	Ø	UM	min. ord. conf.	cat.	prezzo (€)
6621002	P4090G01204000	12x1/2"	NR	5	01	
6621004	P4090G01504000	15x1/2"	NR	5	01	
6621006	P4090G01804000	18x1/2"	NR	10	01	
6621007	P4090G01806000	18x3/4"	NR	5	01	
6621008	P4090G02204000	22x1/2"	NR	5	01	
6621009	P4090G02206000	22x3/4"	NR	5	01	
6621011	P4090G02808000	28x1"	NR	5	01	
6621012	P4090G03510000	35x1"1/4	NR	1	01	

TEE F/F/FILETTO F



codice	sigla	Ø	UM	min. ord. conf.	cat.	prezzo (€)
6624001	P4130G01204012	12x1/2"x12	NR	5	01	
6624003	P4130G01504015	15x1/2"x15	NR	5	01	
6624004	P4130G01804018	18x1/2"x18	NR	5	01	
6624005	P4130G02204022	22x1/2"x22	NR	5	01	
6624006	P4130G02206022	22x3/4"x22	NR	5	01	
6624007	P4130G02804028	28x1/2"x28	NR	5	01	
6624008	P4130G02806028	28x3/4"x28	NR	5	01	
6624009	P4130G03504035	35x1/2"x35	NR	1	01	

MANICOTTO F/FILETTO M



codice	sigla	Ø	UM	min. ord. conf.	cat.	prezzo (€)
6626002	P4243G01204000	12x1/2"	NR	5	01	
6626004	P4243G01504000	15x1/2"	NR	5	01	
6626005	P4243G01506000	15x3/4"	NR	5	01	
6626006	P4243G01804000	18x1/2"	NR	5	01	
6626007	P4243G01806000	18x3/4"	NR	5	01	
6626008	P4243G02204000	22x1/2"	NR	5	01	
6626009	P4243G02206000	22x3/4"	NR	5	01	
6626010	P4243G02208000	22x1"	NR	5	01	
6626011	P4243G02806000	28x3/4"	NR	5	01	
6626012	P4243G02808000	28x1"	NR	5	01	
6626014	P4243G03508000	35x1"	NR	5	01	
6626015	P4243G03510000	35x1"1/4	NR	1	01	
6626016	P4243G03512000	35x1"1/2	NR	1	01	
6626017	P4243G04210000	42x1"1/4	NR	1	01	
6626018	P4243G04212000	42x1"1/2	NR	1	01	
6626020	P4243G05416000	54x2"	NR	1	01	

RACCORDERIA IN RAME-BRONZO

RACCORDERIA A PRESSARE BRONZO ACQUA

MANICOTTO F/FILETTO F



codice	sigla	∅	UM	min. ord. conf.	cat.	prezzo (€)
6628002	P4270G01204000	12x1/2"	NR	5	01	
6628004	P4270G01504000	15x1/2"	NR	5	01	
6628006	P4270G01804000	18x1/2"	NR	5	01	
6628007	P4270G01806000	18x3/4"	NR	5	01	
6628008	P4270G02204000	22x1/2"	NR	5	01	
6628009	P4270G02206000	22x3/4"	NR	5	01	
6628010	P4270G02208000	22x1"	NR	5	01	
6628011	P4270G02806000	28x3/4"	NR	5	01	
6628012	P4270G02808000	28x1"	NR	5	01	
6628013	P4270G02810000	28x1"1/4	NR	5	01	
6628014	P4270G03508000	35x1"	NR	5	01	
6628015	P4270G03510000	35x1"1/4	NR	1	01	
6628016	P4270G04210000	42x1"1/4	NR	1	01	
6628017	P4270G04212000	42x1"1/2	NR	1	01	
6628018	P4270G05416000	54x2"	NR	1	01	

MANICOTTO M/FILETTO F



codice	sigla	∅	UM	min. ord. conf.	cat.	prezzo (€)
6631001	P4281G01204000	12x1/2"	NR	5	01	
6631002	P4281G01504000	15x1/2"	NR	5	01	
6631003	P4281G01804000	18x1/2"	NR	5	01	
6631004	P4281G01806000	18x3/4"	NR	5	01	
6631005	P4281G02204000	22x1/2"	NR	5	01	
6631006	P4281G02206000	22x3/4"	NR	5	01	
6631007	P4281G02806000	28x3/4"	NR	5	01	
6631008	P4281G02808000	28x1"	NR	5	01	
6631009	P4281G03508000	35x1"	NR	1	01	
6631010	P4281G03510000	35x1"1/4	NR	1	01	

GOMITO A 90° F/FILETTO F, CON FLANGIA A 3 FORI DI FISSAGGIO



codice	sigla	∅	UM	min. ord. conf.	cat.	prezzo (€)
6636001	P4471G01204000	12x1/2"	NR	5	01	
6636002	P4471G01504000	15x1/2"	NR	5	01	
6636003	P4471G01804000	18x1/2"	NR	5	01	
6636004	P4471G02206000	22x3/4"	NR	5	01	

RACCORDERIA IN RAME-BRONZO

RACCORDERIA A PRESSARE RAME E BRONZO GAS



Conforme alla norma UNI 11065, UNI CIG 7129

Elastomero giallo in HNBR per gas (EN 549)

- Misure disponibili profilo "V": 15-54 (mm.)

Esternamente i raccordi riportano la scritta GAS ed una doppia striscia gialla di riconoscimento.

CURVA A 90° F/F



codice	sigla	Ø	UM	min. ord. conf.	cat.	prezzo (€)
6670001	PG5002 0150000	15	NR	10	01	
6670002	PG5002 0180000	18	NR	10	01	
6670003	PG5002 0220000	22	NR	10	01	
6670004	PG5002 0280000	28	NR	5	01	
6670005	PG5002 0350000	35	NR	5	01	

CURVA A 90° M/F



codice	sigla	Ø	UM	min. ord. conf.	cat.	prezzo (€)
6669001	PG5001 0150000	15	NR	10	01	
6669002	PG5001 0180000	18	NR	10	01	
6669003	PG5001 0220000	22	NR	10	01	
6669004	PG5001 0280000	28	NR	5	01	
6669005	PG5001 0350000	35	NR	5	01	

CURVA A 45° F/F



codice	sigla	Ø	UM	min. ord. conf.	cat.	prezzo (€)
6672001	PG5041 0150000	15	NR	10	01	
6672002	PG5041 0180000	18	NR	10	01	
6672003	PG5041 0220000	22	NR	10	01	
6672004	PG5041 0280000	28	NR	5	01	
6672005	PG5041 0350000	35	NR	5	01	

CURVA A 45° M/F



codice	sigla	Ø	UM	min. ord. conf.	cat.	prezzo (€)
6671001	PG5040 0150000	15	NR	10	01	
6671002	PG5040 0180000	18	NR	10	01	
6671003	PG5040 0220000	22	NR	10	01	
6671004	PG5040 0280000	28	NR	5	01	
6671005	PG5040 0350000	35	NR	5	01	

TEE F/F/F



codice	sigla	Ø	UM	min. ord. conf.	cat.	prezzo (€)
6673001	PG5130 0151515	15	NR	10	01	
6673003	PG5130 0181818	18	NR	10	01	
6673008	PG5130 0222222	22	NR	10	01	
6673011	PG5130 0282828	28	NR	5	01	
6673014	PG5130 0353535	35	NR	1	01	

TEE RIDOTTO F/F/F



codice	sigla	Ø	UM	min. ord. conf.	cat.	prezzo (€)
6673002	PG5130 0181518	18-15-18	NR	10	01	
6673005	PG5130 0221522	22-15-22	NR	10	01	
6673006	PG5130 0221822	22-18-22	NR	10	01	
6673007	PG5130 0222215	22-22-15	NR	10	01	
6673009	PG5130 0281528	28-15-28	NR	5	01	
6673010	PG5130 0282228	28-22-28	NR	5	01	
6673012	PG5130 0352235	35-22-35	NR	1	01	
6673013	PG5130 0352835	35-28-35	NR	1	01	

MANICOTTO RIDOTTO M/F



codice	sigla	Ø	UM	min. ord. conf.	cat.	prezzo (€)
6674001	PG5243 0181500	18x15	NR	10	01	
6674002	PG5243 0221500	22x15	NR	10	01	
6674003	PG5243 0221800	22x18	NR	10	01	
6674004	PG5243 0281500	28x15	NR	10	01	
6674005	PG5243 0281800	28x18	NR	10	01	
6674006	PG5243 0282200	28x22	NR	10	01	
6674007	PG5243 0352200	35x22	NR	5	01	
6674008	PG5243 0352800	35x28	NR	5	01	

RACCORDERIA IN RAME-BRONZO

RACCORDERIA A PRESSARE RAME E BRONZO GAS

MANICOTTO CON BATTUTA F/F



codice	sigla	Ø	UM	min. ord. conf.	cat.	prezzo (€)
6675001	PG5270 0150000	15	NR	10	01	
6675002	PG5270 0180000	18	NR	10	01	
6675003	PG5270 0220000	22	NR	10	01	
6675004	PG5270 0280000	28	NR	10	01	
6675005	PG5270 0350000	35	NR	5	01	

TAPPO DI CHIUSURA F



codice	sigla	Ø	UM	min. ord. conf.	cat.	prezzo (€)
6676001	PG5301 0150000	15	NR	10	01	
6676002	PG5301 0180000	18	NR	10	01	
6676003	PG5301 0220000	22	NR	10	01	
6676004	PG5301 0280000	28	NR	10	01	
6676005	PG5301 0350000	35	NR	5	01	

CURVA A 90° F/FILETTO M



codice	sigla	Ø	UM	min. ord. conf.	cat.	prezzo (€)
6662001	PG4001G0150400	15x1/2"	NR	5	01	
6662002	PG4001G0180400	18x1/2"	NR	5	01	
6662003	PG4001G0180600	18x3/4"	NR	5	01	
6662004	PG4001G0220600	22x3/4"	NR	5	01	
6662005	PG4001G0280800	28x1"	NR	5	01	

GOMITO A 90° F/FILETTO F



codice	sigla	Ø	UM	min. ord. conf.	cat.	prezzo (€)
6663001	PG4090G0150400	15x1/2"	NR	5	01	
6663003	PG4090G0180400	18x1/2"	NR	5	01	
6663004	PG4090G0180600	18x3/4"	NR	5	01	
6663005	PG4090G0220400	22x1/2"	NR	5	01	
6663006	PG4090G0220600	22x3/4"	NR	5	01	
6663008	PG4090G0280800	28x1"	NR	5	01	

TEE F/F/FILETTO F



codice	sigla	Ø	UM	min. ord. conf.	cat.	prezzo (€)
6664001	PG4130G0150415	15x1/2"x15	NR	5	01	
6664002	PG4130G0180418	18x1/2"x18	NR	5	01	
6664003	PG4130G0220422	22x1/2"x22	NR	5	01	
6664004	PG4130G0220622	22x3/4"x22	NR	5	01	
6664006	PG4130G0280628	28x3/4"x28	NR	5	01	

MANICOTTO F/FILETTO M



codice	sigla	Ø	UM	min. ord. conf.	cat.	prezzo (€)
6665001	PG4243G0150400	15x1/2"	NR	5	01	
6665002	PG4243G0150600	15x3/4"	NR	5	01	
6665003	PG4243G0180400	18x1/2"	NR	5	01	
6665004	PG4243G0180600	18x3/4"	NR	5	01	
6665005	PG4243G0220400	22x1/2"	NR	5	01	
6665006	PG4243G0220600	22x3/4"	NR	5	01	
6665007	PG4243G0220800	22x1"	NR	5	01	
6665008	PG4243G0280600	28x3/4"	NR	5	01	
6665009	PG4243G0280800	28x1"	NR	5	01	
6665011	PG4243G0350800	35x1"	NR	1	01	
6665012	PG4243G0351000	35x1"1/4	NR	1	01	
6665013	PG4243G0351200	35x1"1/2	NR	1	01	

MANICOTTO F/FILETTO F



codice	sigla	Ø	UM	min. ord. conf.	cat.	prezzo (€)
6666001	PG4270G0150400	15x1/2"	NR	5	01	
6666003	PG4270G0180400	18x1/2"	NR	5	01	
6666004	PG4270G0180600	18x3/4"	NR	5	01	
6666005	PG4270G0220400	22x1/2"	NR	5	01	
6666006	PG4270G0220600	22x3/4"	NR	5	01	
6666007	PG4270G0220800	22x1"	NR	5	01	
6666008	PG4270G0280800	28x1"	NR	5	01	
6666009	PG4270G0351000	35x1"1/4	NR	1	01	

GOMITO A 90° F/FILETTO F, CON FLANGIA A 3 FORI DI FISSAGGIO



codice	sigla	Ø	UM	min. ord. conf.	cat.	prezzo (€)
6668001	PG4471G0150400	15x1/2"	NR	5	01	
6668002	PG4471G0180400	18x1/2"	NR	5	01	
6668003	PG4471G0220600	22x3/4"	NR	5	01	

RACCORDERIA IN RAME-BRONZO

RACCORDERIA A PRESSARE IN RAME ARIA CONDIZIONATA E REFRIGERAZIONE



Conforme alla normativa EN 378-2
Elastomero in HNBR nero (EN549)

- Misure in pollici
- Profilo di pressatura BMP

Raccordi in rame per aria condizionata e refrigerazione fino a 48 bar, vuoto 200 micron, temperatura -40°C / +121°C.

CURVA A 90° M/F



codice	sigla	Ø	UM	min. ord. conf.	cat.	prezzo (€)
6750001	MPA5001 0030001	3/8"	NR	3	10	
6750002	MPA5001 0040001	1/2"	NR	3	10	
6750003	MPA5001 0050001	5/8"	NR	3	10	
6750004	MPA5001 0060001	3/4"	NR	3	10	
6750005	MPA5001 0070001	7/8"	NR	3	10	
6750006	MPA5001 0080001	1"	NR	2	10	
6750007	MPA5001 0090001	1"1/8	NR	2	10	
6750008	MPA5001 0110001	1"3/8	NR	1	10	

CURVA A 90° F/F



codice	sigla	Ø	UM	min. ord. conf.	cat.	prezzo (€)
6751001	MPA5002 0020001	1/4"	NR	5	10	
6751002	MPA5002 0030001	3/8"	NR	5	10	
6751003	MPA5002 0040001	1/2"	NR	3	10	
6751004	MPA5002 0050001	5/8"	NR	3	10	
6751005	MPA5002 0060001	3/4"	NR	3	10	
6751006	MPA5002 0070001	7/8"	NR	3	10	
6751007	MPA5002 0080001	1"	NR	2	10	
6751008	MPA5002 0090001	1"1/8	NR	2	10	
6751009	MPA5002 0110001	1"3/8	NR	1	10	

CURVA A 45° F/F



codice	sigla	Ø	UM	min. ord. conf.	cat.	prezzo (€)
6752001	MPA5041 0020001	1/4"	NR	3	10	
6752002	MPA5041 0030001	3/8"	NR	3	10	
6752003	MPA5041 0040001	1/2"	NR	3	10	
6752004	MPA5041 0050001	5/8"	NR	3	10	
6752005	MPA5041 0060001	3/4"	NR	3	10	
6752006	MPA5041 0070001	7/8"	NR	3	10	
6752007	MPA5041 0080001	1"	NR	2	10	
6752008	MPA5041 0090001	1"1/8	NR	2	10	
6752009	MPA5041 0110001	1"3/8	NR	2	10	

MANICOTTO CON BATTUTA F/F



codice	sigla	Ø	UM	min. ord. conf.	cat.	prezzo (€)
6756001	MPA5270 0020001	1/4"	NR	5	10	
6756002	MPA5270 0030001	3/8"	NR	5	10	
6756003	MPA5270 0040001	1/2"	NR	5	10	
6756004	MPA5270 0050001	5/8"	NR	5	10	
6756005	MPA5270 0060001	3/4"	NR	2	10	
6756006	MPA5270 0070001	7/8"	NR	2	10	
6756007	MPA5270 0080001	1"	NR	2	10	
6756008	MPA5270 0090001	1"1/8	NR	2	10	
6756009	MPA5270 0110001	1"3/8	NR	2	10	

MANICOTTO PASSANTE F/F



codice	sigla	Ø	UM	min. ord. conf.	cat.	prezzo (€)
6758001	MPA5275L0020001	1/4"	NR	5	10	
6758002	MPA5275L0030001	3/8"	NR	5	10	
6758003	MPA5275L0040001	1/2"	NR	5	10	
6758004	MPA5275L0050001	5/8"	NR	3	10	
6758005	MPA5275L0060001	3/4"	NR	2	10	
6758006	MPA5275L0070001	7/8"	NR	2	10	
6758007	MPA5275L0080001	1"	NR	1	10	
6758008	MPA5275L0090001	1"1/8	NR	1	10	

RACCORDERIA IN RAME-BRONZO

RACCORDERIA A PRESSURE IN RAME ARIA CONDIZIONATA E REFRIGERAZIONE

MANICOTTO RIDOTTO F/F



codice	sigla	Ø	UM	min. ord. conf.	cat.	prezzo (€)
6753001	MPA5240 0030201	3/8"x1/4"	NR	2	10	
6753002	MPA5240 0040201	1/2"x1/4"	NR	2	10	
6753003	MPA5240 0040301	1/2"x3/8"	NR	2	10	
6753004	MPA5240 0050301	5/8"x3/8"	NR	2	10	
6753005	MPA5240 0050401	5/8"x1/2"	NR	2	10	
6753006	MPA5240 0060301	3/4"x3/8"	NR	2	10	
6753007	MPA5240 0060401	3/4"x1/2"	NR	2	10	
6753008	MPA5240 0060501	3/4"x5/8"	NR	2	10	
6753009	MPA5240 0070401	7/8"x1/2"	NR	2	10	
6753010	MPA5240 0070501	7/8"x5/8"	NR	2	10	
6753011	MPA5240 0070601	7/8"x3/4"	NR	2	10	
6753012	MPA5240 0080601	1"x3/4"	NR	1	10	
6753013	MPA5240 0090501	1"1/8x5/8"	NR	1	10	
6753014	MPA5240 0090601	1"1/8x3/4"	NR	1	10	
6753015	MPA5240 0090701	1"1/8x7/8"	NR	1	10	
6753016	MPA5240 0090801	1"1/8x1"	NR	1	10	
6753017	MPA5240 0110701	1"3/8x7/8"	NR	1	10	
6753018	MPA5240 0110801	1"3/8x1"	NR	1	10	
6753019	MPA5240 0110901	1"3/8x1"1/8	NR	1	10	

MANICOTTO RIDOTTO M/F



codice	sigla	Ø	UM	min. ord. conf.	cat.	prezzo (€)
6755001	MPA5243 0030201	3/8"x1/4"	NR	2	10	
6755002	MPA5243 0040301	1/2"x3/8"	NR	2	10	
6755003	MPA5243 0050301	5/8"x3/8"	NR	2	10	
6755004	MPA5243 0050401	5/8"x1/2"	NR	2	10	
6755005	MPA5243 0060401	3/4"x1/2"	NR	2	10	
6755006	MPA5243 0060501	3/4"x5/8"	NR	2	10	
6755007	MPA5243 0070401	7/8"x1/2"	NR	2	10	
6755008	MPA5243 0070501	7/8"x5/8"	NR	2	10	
6755009	MPA5243 0070601	7/8"x3/4"	NR	2	10	
6755010	MPA5243 0090401	1"1/8x1/2"	NR	1	10	
6755011	MPA5243 0090501	1"1/8x5/8"	NR	1	10	
6755012	MPA5243 0090601	1"1/8x3/4"	NR	1	10	
6755013	MPA5243 0090701	1"1/8x7/8"	NR	1	10	
6755014	MPA5243 0110701	1"3/8x7/8"	NR	1	10	
6755015	MPA5243 0110801	1"3/8x1"	NR	1	10	
6755016	MPA5243 0110901	1"3/8x1"1/8	NR	1	10	

TEE F/F / F



codice	sigla	Ø	UM	min. ord. conf.	cat.	prezzo (€)
6764001	MPA5T 002020201	1/4"	NR	3	10	
6764002	MPA5T 003030301	3/8"	NR	3	10	
6764003	MPA5T 004040401	1/2"	NR	3	10	
6764004	MPA5T 005050501	5/8"	NR	2	10	
6764005	MPA5T 006060601	3/4"	NR	2	10	
6764006	MPA5T 007070701	7/8"	NR	2	10	
6764007	MPA5T 008080801	1"	NR	1	10	
6764008	MPA5T 009090901	1"1/8	NR	1	10	
6764009	MPA5T 011111101	1"3/8	NR	1	10	

TAPPO F



codice	sigla	Ø	UM	min. ord. conf.	cat.	prezzo (€)
6763001	MPA5301 0020001	1/4"	NR	3	10	
6763002	MPA5301 0030001	3/8"	NR	3	10	
6763003	MPA5301 0040001	1/2"	NR	3	10	
6763004	MPA5301 0050001	5/8"	NR	2	10	
6763005	MPA5301 0060001	3/4"	NR	2	10	
6763006	MPA5301 0070001	7/8"	NR	2	10	
6763007	MPA5301 0080001	1"	NR	1	10	
6763008	MPA5301 0090001	1"1/8	NR	1	10	
6763009	MPA5301 0110001	1"3/8	NR	1	10	

MANICOTTO CARTELLATO IN RAME, DADO GIREVOLE IN OTTONE



codice	sigla	Ø	UM	min. ord. conf.	cat.	prezzo (€)
6759001	MPA5285G0020201	1/4"	NR	4	10	
6759002	MPA5285G0030301	3/8"	NR	4	10	
6759003	MPA5285G0040401	1/2"	NR	2	10	
6759004	MPA5285G0050501	5/8"	NR	2	10	
6759005	MPA5285G0060601	3/4"	NR	2	10	

MISURATORE DI PROFONDITÀ E PENNARELLO



codice	sigla	Ø	UM	min. ord. conf.	cat.	prezzo (€)
6766001	MPA DEPTH GAUGE	1/4" - 1"3/8	NR	1	10	

LUBRIFICANTE PER O-RING 100ml



codice	sigla	UM	min. ord. conf.	cat.	prezzo (€)	
6766002	MPABPSOIL100ML	NR	1	25	10	

RACCORDERIA PER TUBO POLIETILENE

RACCORDERIA A COMPRESIONE E PRESE STAFFA

PRESSIONE NOMINALE A 20°

- Raccordi a compressione: PN 16bar
- Prese a Staffa: PN 10bar

TEMPERATURA MASSIMA D'IMPIEGO

Fino a 45°C nei limiti dei campi d'impiego dei tubi di polietilene.

NORME DI RIFERIMENTO

- Conformi alle normative ISO, UNI, DIN
- Filettature UNI-ISO 7/1, DIN 2999, BS 21, EN 10226-1
- Flange UNI 2223, DIN 8063, UNI EN 1092-1, UNI 2278

PRESCRIZIONI SANITARIE

- Conformi a D.M. n° 174 del 06/04/2004

MATERIALI DEI COMPONENTI

- Raccordi a compressione:
Corpo del raccordo in polipropilene nero (PP-B) ad alto grado di stabilità con protezione anti UV.
Guarnizione in Gomma nitrilica nera (NBR). Bussola in polipropilene nero (PP-B). Anello di graffaggio in resina acetalica bianca (POM). Ghiera in polipropilene azzurro (PP).
- Prese a staffa:
Bulloni in acciaio galvanizzato. Fondo staffa in polipropilene nero (PP). Guarnizione in gomma nitrilica nera (NBR). Derivazione staffa in polipropilene nero (PP).

MANICOTTO



codice	sigla	Ø	UM	min. ord.	conf.	cat.	prezzo (€)
4830001	1001016000001	16	NR	70	70	02	
4830002	1001020000001	20	NR	50	50	02	
4830003	1001025000001	25	NR	30	30	02	
4830004	1001032000001	32	NR	20	20	02	
4830005	1001040000001	40	NR	10	10	02	
4830006	1001051000001	50	NR	1	23	02	
4830007	1001064000001	63	NR	1	15	02	
4830008	1001076000001	75	NR	1	11	02	
4830009	1001091000001	90	NR	1	6	02	
4830010	1001111000001	110	NR	1	4	02	

MANICOTTO RIDOTTO



codice	sigla	Ø	UM	min. ord.	conf.	cat.	prezzo (€)
4831002	1002025020001	25x20	NR	40	40	02	
4831003	1002032025001	32x25	NR	25	25	02	
4831005	1002040032001	40x32	NR	15	15	02	
4831007	1002051032001	50x32	NR	1	8	02	
4831008	1002051040001	50x40	NR	1	6	02	

RACCORDO FEMMINA

La bocca filettata è rinforzata da anello in acciaio inox dal Ø 40 in poi.



codice	sigla	Ø	UM	min. ord.	conf.	cat.	prezzo (€)
4833003	1004020002001	20x1/2"	NR	90	90	02	
4833004	1004020003001	20x3/4"	NR	90	90	02	
4833007	1004025003001	25x3/4"	NR	50	50	02	
4833010	1004032003001	32x3/4"	NR	30	30	02	
4833011	1004032004001	32x1"	NR	30	30	02	
4833014	1004040005001	40x1"1/4	NR	20	20	02	
4833017	1004051006001	50x1"1/2	NR	1	45	02	
4833021	1004064007001	63x2"	NR	1	28	02	
4833024	1004076008001	75x2"1/2	NR	1	18	02	
4833028	1004091009001	90x3"	NR	1	10	02	
4833031	1004111010001	110x4"	NR	1	6	02	

RACCORDO MASCHIO



codice	sigla	Ø	UM	min. ord.	conf.	cat.	prezzo (€)
4832002	1003016002001	16x1/2"	NR	140	140	02	
4832004	1003020002001	20x1/2"	NR	80	80	02	
4832005	1003020003001	20x3/4"	NR	80	80	02	
4832008	1003025003001	25x3/4"	NR	50	50	02	
4832009	1003025004001	25x1"	NR	50	50	02	
4832010	1003032003001	32x3/4"	NR	30	30	02	
4832011	1003032004001	32x1"	NR	30	30	02	
4832013	1003040004001	40x1"	NR	20	20	02	
4832014	1003040005001	40x1"1/4	NR	20	20	02	
4832015	1003040006001	40x1"1/2	NR	20	20	02	
4832019	1003051006001	50x1"1/2	NR	1	45	02	
4832020	1003051007001	50x2"	NR	1	45	02	
4832023	1003064007001	63x2"	NR	1	28	02	
4832026	1003076008001	75x2"1/2	NR	1	18	02	
4832030	1003091009001	90x3"	NR	1	10	02	
4832034	1003111010001	110x4"	NR	1	6	02	

GOMITO A 90°



codice	sigla	Ø	UM	min. ord.	conf.	cat.	prezzo (€)
4835002	1006020000001	20	NR	50	50	02	
4835003	1006025000001	25	NR	30	30	02	
4835004	1006032000001	32	NR	20	20	02	
4835005	1006040000001	40	NR	10	10	02	
4835006	1006051000001	50	NR	1	22	02	
4835007	1006064000001	63	NR	1	13	02	
4835008	1006076000001	75	NR	1	9	02	
4835009	1006091000001	90	NR	1	5	02	
4835010	1006111000001	110	NR	1	4	02	

RACCORDERIA PER TUBO POLIETILENE

RACCORDERIA A COMPRESSIONE E PRESE STAFFA

GOMITO A 90° CON DERIVAZIONE MASCHIO



codice	sigla	Ø	UM	min. ord.	conf.	cat.	prezzo (€)
4837003	1008020002001	20x1/2"	NR	75	75	02	
4837004	1008020003001	20x3/4"	NR	75	75	02	
4837005	1008025002001	25x1/2"	NR	50	50	02	
4837006	1008025003001	25x3/4"	NR	50	50	02	
4837010	1008032004001	32x1"	NR	30	30	02	
4837013	1008040005001	40x1"1/4	NR	15	15	02	
4837016	1008051006001	50x1"1/2	NR	1	36	02	
4837019	1008064007001	63x2"	NR	1	20	02	
4837021	1008076008001	75x2"1/2	NR	1	13	02	
4837023	1008091009001	90x3"	NR	1	7	02	

GOMITO A 90° CON DERIVAZIONE FEMMINA

La bocca filettata è rinforzata da anello in acciaio inox dal Ø 40x1"1/4 in poi.



codice	sigla	Ø	UM	min. ord.	conf.	cat.	prezzo (€)
4838003	1009020002001	20x1/2"	NR	60	60	02	
4838004	1009020003001	20x3/4"	NR	60	60	02	
4838005	1009025002001	25x1/2"	NR	35	35	02	
4838006	1009025003001	25x3/4"	NR	35	35	02	
4838009	1009032003001	32x3/4"	NR	25	25	02	
4838010	1009032004001	32x1"	NR	25	25	02	
4838013	1009040004001	40x1"	NR	15	15	02	
4838014	1009040005001	40x1"1/4	NR	15	15	02	
4838017	1009051006001	50x1"1/2	NR	1	29	02	
4838020	1009064007001	63x2"	NR	1	17	02	
4838023	1009076008001	75x2"1/2	NR	1	10	02	
4838025	1009091009001	90x3"	NR	1	6	02	

TEE A 90°



codice	sigla	Ø	UM	min. ord.	conf.	cat.	prezzo (€)
4834001	1005016000001	16	NR	40	40	02	
4834002	1005020000001	20	NR	30	30	02	
4834003	1005025000001	25	NR	15	15	02	
4834004	1005032000001	32	NR	10	10	02	
4834005	1005040000001	40	NR	6	6	02	
4834006	1005051000001	50	NR	1	13	02	
4834007	1005064000001	63	NR	1	7	02	
4834008	1005076000001	75	NR	1	4	02	
4834009	1005091000001	90	NR	1	2	02	

GOMITO A 90° CON DERIVAZIONE LATERALE FEMMINA



codice	sigla	Ø	UM	min. ord.	conf.	cat.	prezzo (€)
4845001	1023025002001	25x1/2"	NR	25	25	02	
4845003	1023032003001	32x3/4"	NR	20	20	02	

TEE A 90° CON DERIVAZIONE FEMMINA

La bocca filettata è rinforzata da anello in acciaio inox dal Ø 40 in poi.



codice	sigla	Ø	UM	min. ord.	conf.	cat.	prezzo (€)
4836003	1007020002001	20x1/2"x20	NR	40	40	02	
4836006	1007025003001	25x3/4"x25	NR	25	25	02	
4836009	1007032003001	32x3/4"x32	NR	15	15	02	
4836010	1007032004001	32x1"x32	NR	15	15	02	
4836013	1007040005001	40x1"1/4x40	NR	8	8	02	
4836016	1007051006001	50x1"1/2x50	NR	1	18	02	
4836020	1007064007001	63x2"x63	NR	1	12	02	
4836023	1007076008001	75x2"1/2x75	NR	1	7	02	
4836026	1007091009001	90x3"x90	NR	1	4	02	

TAPPO FINE LINEA



codice	sigla	Ø	UM	min. ord.	conf.	cat.	prezzo (€)
4841001	1012016000001	16	NR	140	140	02	
4841002	1012020000001	20	NR	100	100	02	
4841003	1012025000001	25	NR	50	50	02	
4841004	1012032000001	32	NR	40	40	02	
4841005	1012040000001	40	NR	20	20	02	
4841006	1012051000001	50	NR	10	52	02	
4841007	1012064000001	63	NR	1	30	02	
4841008	1012076000001	75	NR	1	22	02	
4841009	1012091000001	90	NR	1	12	02	

RACCORDERIA PER TUBO POLIETILENE

RACCORDERIA A COMPRESSIONE E PRESE STAFFA

PRESA A STAFFA



codice	sigla	Ø	UM	min. ord.	conf.	cat.	prezzo (€)
4880001	1019025002001	25x1/2"	NR	1	180	07	
4880003	1019032002001	32x1/2"	NR	1	140	07	
4880004	1019032003001	32x3/4"	NR	1	140	07	
4880006	1019040002001	40x1/2"	NR	1	110	07	
4880007	1019040003001	40x3/4"	NR	1	110	07	
4880008	1019040004001	40x1"	NR	1	110	07	
4880009	1019050002001	50x1/2"	NR	1	80	07	
4880010	1019050003001	50x3/4"	NR	1	80	07	
4880013	1019063002001	63x1/2"	NR	1	55	07	
4880014	1019063003001	63x3/4"	NR	1	55	07	
4880023	1019075007001	75x2"	NR	1	40	07	

PRESA A STAFFA CON ANELLO DI RINFORZO



codice	sigla	Ø	UM	min. ord.	conf.	cat.	prezzo (€)
4882001	1026025002001	25x1/2"	NR	1	180	07	
4882002	1026025003001	25x3/4"	NR	1	180	07	
4882003	1026032002001	32x1/2"	NR	1	140	07	
4882004	1026032003001	32x3/4"	NR	1	140	07	
4882006	1026040002001	40x1/2"	NR	1	110	07	
4882007	1026040003001	40x3/4"	NR	1	110	07	
4882008	1026040004001	40x1"	NR	1	110	07	
4882009	1026050002001	50x1/2"	NR	1	80	07	
4882010	1026050003001	50x3/4"	NR	1	80	07	
4882011	1026050004001	50x1"	NR	1	80	07	
4882012	1026050005001	50x1/4"	NR	1	80	07	
4882014	1026063003001	63x3/4"	NR	1	55	07	
4882015	1026063004001	63x1"	NR	1	55	07	
4882016	1026063005001	63x1"1/4	NR	1	55	07	
4882017	1026063006001	63x1"1/2	NR	1	55	07	
4882022	1026075006001	75x1"1/2	NR	1	40	07	
4882029	1026090007001	90x2"	NR	1	30	07	
4882035	1026110007001	110x2"	NR	1	19	07	

PRESA A STAFFA CON ANELLO DI RINFORZO PN 16 BAR



codice	sigla	Ø	UM	min. ord.	conf.	cat.	prezzo (€)
4884001	1031020002001	20x1/2"	NR	30	30	07	
4884003	1031025003001	25x3/4"	NR	30	30	07	

RACCORDERIA PER TUBO POLIETILENE

GIUNTI DI TRANSIZIONE

GIUNTI TRANSIZIONE CURVI RIVESTITI FILETTATI GAS/ACQUA

Giunti di transizione acciaio-PE - PE 100/SDR 11 - S5 GAS - PN 16 20°C
CONFORME NORMATIVA UNI CEI EN ISO/IEC 1750 - NORMA UNI 9736



codice	sigla	Ø	UM	min. ord.	conf.	cat.	prezzo (€)
4801001	3696025003001	25x3/4"	NR	1	14	02	
4801002	3696032004001	32x1"	NR	1	12	02	
4801003	3696040005001	40x1"1/4	NR	1	10	02	
4801004	3696050006001	50x1"1/2	NR	1	8	02	
4801005	3696063007001	63x2"	NR	1	5	02	

GIUNTI TRANSIZIONE RETTILINEI RIVESTITI FILETTATI GAS/ACQUA

Giunti di transizione acciaio-PE - PE 100/SDR 11 - S5 GAS - PN 16 20°C
CONFORME NORMATIVA UNI CEI EN ISO/IEC 1750 - NORMA UNI 9736



codice	sigla	Ø	UM	min. ord.	conf.	cat.	prezzo (€)
4802001	3666025003001	25x3/4"	NR	1	30	02	
4802002	3666032004001	32x1"	NR	1	30	02	
4802003	3666040005001	40x1"1/4	NR	1	20	02	
4802004	3666050006001	50x1"1/2	NR	1	15	02	
4802005	3666063007001	63x2"	NR	1	10	02	
4802006	3666075008001	75x2"1/2	NR	1	8	02	
4802007	3666090009001	90x3"	NR	1	6	02	
4802008	3666110010001	110x4"	NR	1	4	02	

GIUNTI TRANSIZIONE RETTILINEI IN RAME GAS/ACQUA

Giunti di transizione rame-PE
PE 100/SDR 11 - S5 GAS - PN 16 20°C



codice	sigla	Ø	UM	min. ord.	conf.	cat.	prezzo (€)
4805001	3676032022001	32x22	NR	1	60	02	

GIUNTI DIELETRICI FILETTATI MF

Giunto isolante (dielettrico) PN10 idoneo per utenze gas e acqua.
Temperatura massima 70°C.
CONFORME ALLA NORMATIVA UNI CIG 10284.



codice	Ø	UM	min. ord.	conf.	cat.	prezzo (€)
● 4501001	1/2"	NR	1	10	03	
● 4501002	3/4"	NR	1	10	03	
● 4501003	1"	NR	1	5	03	
● 4501004	1"1/4	NR	1	5	03	
● 4501005	1"1/2	NR	1	5	03	
● 4501006	2"	NR	1	3	03	
● 4501007	2"1/2	NR	1	2	03	
● 4501008	3"	NR	1	2	03	
● 4501009	4"	NR	1	2	03	

GIUNTI TRANSIZIONE OTTONE FILETTATI MASCHIO A SALDARE

Giunti di transizione ottone-PE - PE 100/SDR 11 - S5 GAS - PN 16 20°C
CONFORME NORMATIVA UNI CEI EN ISO/IEC 1750 - NORMA UNI 9736



codice	sigla	Ø	UM	min. ord.	conf.	cat.	prezzo (€)
4808001	3626025003001	25x3/4"	NR	1	80	02	
4808002	3626032004001	32x1"	NR	1	50	02	
4808003	3626040005001	40x1"1/4	NR	1	30	02	
4808004	3626050006001	50x1"1/2	NR	1	20	02	
4808005	3626063007001	63x2"	NR	1	12	02	
4808006	3626075008001	75x2"1/2	NR	1	6	02	
4808007	3626090009001	90x3"	NR	1	4	02	

GIUNTI TRANSIZIONE OTTONE FILETTATI FEMMINA A SALDARE

Giunti di transizione ottone-PE - PE 100/SDR 11 - S5 GAS - PN 16 20°C
CONFORME NORMATIVA UNI CEI EN ISO/IEC 1750 - NORMA UNI 9736



codice	sigla	Ø	UM	min. ord.	conf.	cat.	prezzo (€)
4809001	3636025003001	25x3/4"	NR	1	90	02	
4809003	3636032004001	32x1"	NR	1	65	02	
4809005	3636040005001	40x1"1/4	NR	1	30	02	
4809007	3636050006001	50x1"1/2	NR	1	20	02	
4809009	3636063007001	63x2"	NR	1	12	02	
4809010	3636075008001	75x2"1/2	NR	1	6	02	
4809011	3636090009001	90x3"	NR	1	6	02	

RACCORDERIA PER TUBO POLIETILENE

RACCORDI ELETTROSALDABILI E TESTA/TESTA

INFORMAZIONI TECNICHE GENERALI

LIMITI DI IMPIEGO

I raccordi elettrosaldabili realizzati in PE100 sono accoppiabili con tubi PE80 e PE100 aventi SDR 26 (tranne i diametri fino al 125 mm), SDR17, e SDR136 (tranne i diametri fino al 32 mm), SDR 11 e SDR 7,4 (per tutti i diametri). Sono omologati per pressioni nominali di 16 bar per acqua e S5 per gas salvo diverse specifiche indicate per ciascun articolo. La pressione di esercizio della giunzione (sistema tubo + raccordo) è la minima fra la pressione nominale del tubo e la pressione nominale del raccordo.

CARATTERISTICHE

Collegamenti elettrici a mezzo di morsetti Ø 4,0 mm con tensione di saldatura 40,0 V. Su ogni articolo è riportato: codice a barre per la lettura con penna ottica, diametro nominale, tempo di fusione e tempo di raffreddamento.

PRESCRIZIONI SANITARIE

I raccordi elettrosaldabili sono prodotti con materiali idonei al convogliamento di acqua potabile e fluidi alimentari secondo le leggi e prescrizioni vigenti in Italia ed in numerosi altri Paesi. Sono inoltre conformi alle norme igienico-sanitarie del Decreto Ministeriale n°174 del 06/04/2004.

MATERIALE

Polietilene alta densità (HDPE).

MARCHIO DI CONFORMITA'

IIP (Istituto Italiano Plastici) secondo le normative UNI EN 12201, UNI EN 1555, EN 12201, EN1555.

MANICOTTO

PE 100 - S5 GAS - PN 16 20°C



codice	sigla	Ø	UM	min. ord.	conf.	cat.	prezzo (€)
4820002	3001025000001	25	NR	1	20	02	
4820003	3001032000001	32	NR	1	20	02	
4820004	3001040000001	40	NR	1	20	02	
4820005	3001050000001	50	NR	1	10	02	
4820006	3001063000001	63	NR	1	10	02	
4820007	3001075000001	75	NR	1	15	02	
4820008	3001090000001	90	NR	1	18	02	
4820009	3001110000001	110	NR	1	30	02	
4820010	3001125000001	125	NR	1	8	02	
4820011	3001140000001	140	NR	1	2	02	
4820012	3001160000001	160	NR	1	10	02	

MANICOTTO DI RIDUZIONE

PE 100 - S5 GAS - PN 16 20°C



codice	sigla	Ø	UM	min. ord.	conf.	cat.	prezzo (€)
4820103	3002032025001	32x25	NR	1	20	02	
4820104	3002040032001	40x32	NR	1	20	02	
4820105	3002050032001	50x32	NR	1	10	02	
4820106	3002063032001	63x32	NR	1	10	02	
4820107	3002063040001	63x40	NR	1	10	02	
4820108	3002063050001	63x50	NR	1	10	02	
4820120	3002075063001	75x63	NR	1	15	02	
4820109	3002090063001	90x63	NR	1	10	02	
4820110	3002090075001	90x75	NR	1	10	02	
4820111	3002110090001	110x90	NR	1	12	02	
4820113	3002125090001	125x90	NR	1	8	02	
4820122	3002125110001	125x110	NR	1	4	02	

GOMITO A 90°

PE 100 - S5 GAS - PN 16 20°C



codice	sigla	Ø	UM	min. ord.	conf.	cat.	prezzo (€)
4821101	3004025000001	25	NR	1	20	02	
4821102	3004032000001	32	NR	1	20	02	
4821103	3004040000001	40	NR	1	10	02	
4821104	3004050000001	50	NR	1	20	02	
4821105	3004063000001	63	NR	1	10	02	
4821106	3004075000001	75	NR	1	6	02	
4821107	3004090000001	90	NR	1	5	02	
4821108	3004110000001	110	NR	1	3	02	
4821109	3004125000001	125	NR	1	2	02	
4821112	3004140000001	140	NR	1	3	02	

GOMITO A 45°

PE 100 - S5 GAS - PN 16 20°C



codice	sigla	Ø	UM	min. ord.	conf.	cat.	prezzo (€)
4821201	3005032000001	32	NR	1	20	02	
4821202	3005040000001	40	NR	1	12	02	
4821203	3005050000001	50	NR	1	9	02	
4821204	3005063000001	63	NR	1	10	02	
4821205	3005075000001	75	NR	1	10	02	
4821206	3005090000001	90	NR	1	5	02	
4821207	3005110000001	110	NR	1	3	02	
4821208	3005125000001	125	NR	1	2	02	
4821211	3005140000001	140	NR	1	3	02	

RACCORDERIA PER TUBO POLIETILENE

RACCORDI ELETTROSALDABILI E TESTA/TESTA

TEE INTERMEDIO

PE 100 - S5 GAS - PN 16 20°C



codice	sigla	Ø	UM	min. ord.	conf.	cat.	prezzo (€)
4821002	3003025000001	25	NR	1	20	02	
4821003	3003032000001	32	NR	1	20	02	
4821004	3003040000001	40	NR	1	10	02	
4821005	3003050000001	50	NR	1	10	02	
4821006	3003063000001	63	NR	1	5	02	
4821007	3003075000001	75	NR	1	5	02	
4821008	3003090000001	90	NR	1	4	02	
4821009	3003110000001	110	NR	1	4	02	
4821010	3003125000001	125	NR	1	2	02	
4821013	3003140000001	140	NR	1	2	02	

RIDUZIONE TESTA/TESTA

SDR 11 - S5 - PN 16



codice	sigla	Ø	UM	min. ord.	conf.	cat.	prezzo (€)
4826009	3140050040001	50x40	NR	1	54	02	
4826016	3140075063001	75x63	NR	1	20	02	
4826020	3140110063001	110x63	NR	1	9	02	
4826021	3140110075001	110x75	NR	1	9	02	
4826023	3140125110001	125x110	NR	1	19	02	
4826026	3140140110001	140x110	NR	1	18	02	

CARTELLA

SDR 11 - S5 - PN 16



codice	sigla	Ø	UM	min. ord.	conf.	cat.	prezzo (€)
4826504	3145063000001	63	NR	1	18	02	
4826505	3145075000001	75	NR	1	11	02	
4826506	3145090000001	90	NR	1	30	02	
4826507	3145110000001	110	NR	1	18	02	
4826508	3145125000001	125	NR	1	16	02	
4826509	3145140000001	140	NR	1	12	02	

FLANGIA IN ACCIAIO ZINCATO

SDR 11 - S5 - PN 16



codice	sigla	Ø	DN	UM	min. ord.	conf.	cat.	prezzo (€)
4825104	3806063000001	63	50	NR	1	1	02	
4825105	3806075000001	75	65	NR	1	1	02	
4825106	3806090000001	90	80	NR	1	1	02	
4825107	3806110000001	110	100	NR	1	1	02	
4825108	3806125000001	125	100	NR	1	1	02	
4825109	3806140000001	140	125	NR	1	1	02	

GIUNTI ESTENSIBILI ED ANTIVIBRANTI GAS E ACQUA

TUBI FLESSIBILI GIUNTI ANTIVIBRANTI

TUBO GAS ECOGAS USO DOMESTICO A NORMA UNI EN 14800

Tubo: acciaio inossidabile AISI 316L. Raccordi: acciaio inossidabile AISI 303 filettatura normativa EN 14800. Canotto portagirello: acciaio inossidabile AISI 303 sede di tenuta normativa EN 14800. Dado: acciaio inossidabile AISI 303 filettatura normativa EN 14800. Pressione massima: 0,5 bar. Temperatura massima: 100°C



codice	Ø	mm	tipo	UM	min. ord. conf.	cat.	prezzo (€)
● 4701211	1/2"	500	MF / FG	NR	1	21	
● 4701212	1/2"	500	FG / FG	NR	1	21	
● 4701215	1/2"	1000	MF / FG	NR	1	21	
● 4701216	1/2"	1000	FG / FG	NR	1	21	
● 4701219	1/2"	1500	MF / FG	NR	1	21	
● 4701220	1/2"	1500	FG / FG	NR	1	21	
● 4701221	1/2"	2000	MF / FG	NR	1	21	
● 4701222	1/2"	2000	FG / FG	NR	1	21	

TUBO GAS USO DOMESTICO A NORMA UNI EN 14800

Tubo: acciaio inossidabile AISI 316L. Raccordo maschio: acciaio inossidabile AISI 303 filettatura normativa EN 14800. Canotto portagirello: acciaio inox AISI 303 sede di tenuta normativa EN 14800. **Dado: acciaio inox AISI 303** filettatura normativa EN 14800.



codice	sigla	Ø	mm	tipo	UM	min. ord. conf.	cat.	prezzo (€)
4701101	E0781500	1/2"	500	MF/FG	NR	12	07	
4701102	E0781510	1/2"	500	FG/FG	NR	12	07	
4701103	E0781501	1/2"	750	MF/FG	NR	12	07	
4701104	E0781511	1/2"	750	FG/FG	NR	12	07	
4701105	E0781502	1/2"	1000	MF/FG	NR	12	07	
4701106	E0781512	1/2"	1000	FG/FG	NR	12	07	
4701109	E0781504	1/2"	1500	MF/FG	NR	12	07	
4701110	E0781514	1/2"	1500	FG/FG	NR	12	07	
4701111	E0781505	1/2"	2000	MF/FG	NR	12	07	
4701112	E0781515	1/2"	2000	FG/FG	NR	12	07	

FLESS. ESTENSIBILE PER GAS A NORMA UNI 11353:2010

Giunto estensibile inox AISI 316L spessore > 0,21 mm, guaina esterna in materiale termoretraibile. Raccordo, canotto, portagirello e dado in acciaio inox AISI 303; guarnizione in gomma EN 549: Raccordo maschio UNI EN 10226-1, dado ISO 228/1.

GIRELLO INOX



codice	sigla	MF/FG	mm	UM	min. ord. conf.	cat.	prezzo (€)
4702001	0801503	1/2"	90/130	NR	12	01	
4702003	0801504	1/2"	120/210	NR	12	01	
4702005	0801505	1/2"	180/300	NR	12	01	
4702007	0801506	1/2"	240/410	NR	12	01	
4702009	0801507	1/2"	290/470	NR	12	01	
4702031	0809903	1/2"x3/4"	90/130	NR	12	01	
4702032	0809904	1/2"x3/4"	120/210	NR	12	01	
4702034	0809906	1/2"x3/4"	240/410	NR	12	01	
4702011	0802003	3/4"	90/130	NR	12	01	
4702013	0802004	3/4"	120/210	NR	12	01	
4702015	0802005	3/4"	180/300	NR	12	01	
4702017	0802006	3/4"	240/410	NR	12	01	
4702019	0802007	3/4"	290/520	NR	12	01	
4702023	0802504	1"	120/210	NR	12	01	
4702027	0802506	1"	240/410	NR	12	01	

LEGENDA:
MF = Maschio fisso
FG = Femmina girevole

KIT TUBO GAS

Kit pronto all'installazione di piani cottura, caldaie e bruciatori gas, scaldabagni. Composto da tubo corrugato pieghevole in acciaio inox AISI 316L per gas con rivestimento protettivo giallo in LDPE, già cartellato e raccordato, completo di collari di fissaggio. Conforme alla normativa Europea UNI 15266:2007, alla normativa italiana di installazione UNI 7129:2015 e alla normativa italiana per impianti extracivili superiori a 35kw UNI 11528:2014.



codice	sigla	Ø	lunghezza (mt)	UM	min. ord. conf.	cat.	prezzo (€)
4701140	2581225R	DN12 - 1/2"	2,5	NR	1	01	
4701139	2581230R	DN12 - 1/2"	3	NR	1	01	
4701138	2581235R	DN12 - 1/2"	3,5	NR	1	01	
4701137	2581240R	DN12 - 1/2"	4	NR	1	01	

FLESS. ESTENSIBILE PER GAS A NORMA UNI 11353:2010

Giunto estensibile inox AISI 316L spessore > 0,21 mm. guaina esterna in materiale termoretraibile. Raccordo, canotto e dado in acciaio inox AISI 303, portagirello in ottone, guarnizione in gomma EN549. Raccordo maschio UNI EN 10226-1, dado ISO 228/1.

GIRELLO OTTONE



codice	sigla	MF/FG	mm	UM	min. ord. conf.	cat.	prezzo (€)
4703001	0811504	1/2"	120/210	NR	12	01	
4703002	0811506	1/2"	240/410	NR	12	01	
4703007	0819904	1/2x3/4"	120/210	NR	12	01	
4703008	0819906	1/2x3/4"	240/410	NR	12	01	
4703003	0812004	3/4"	120/210	NR	12	01	
4703004	0812006	3/4"	240/410	NR	12	01	
4703006	0812506	1"	240/410	NR	12	01	

GIUNTI ESTENSIBILI ED ANTIVIBRANTI GAS E ACQUA

TUBI FLESSIBILI GIUNTI ANTIVIBRANTI

FLESS. ESTENSIBILE CALDAIA SENZA RIVESTIMENTO

Giunto estensibile in acciaio inox AISI 304 spessore > 0,21mm. Raccordo maschio, canotto portagirello in acciaio inox AISI 303. Dado in ottone nichelato. Raccordo maschio UNI EN 10226-1, dado ISO 228/1.



codice	sigla	MF/FG	mm	UM	min. ord. conf.	cat.	prezzo (€)
4601003	0501004	3/8"	110/210	NR	12	01	
4601005	0501006	3/8"	200/410	NR	12	01	
4601009	0501503	1/2"	75/130	NR	12	01	
4601011	0501504	1/2"	110/210	NR	12	01	
4601013	0501506	1/2"	200/410	NR	12	01	
4601015	0501507	1/2"	260/520	NR	12	01	
4601054	0509904	1/2"x3/4"	110/210	NR	12	01	
4601055	0509906	1/2"x3/4"	200/410	NR	12	01	
4601017	0502003	3/4"	75/130	NR	12	01	
4601019	0502004	3/4"	110/210	NR	12	01	
4601021	0502006	3/4"	200/410	NR	12	01	
4601023	0502007	3/4"	260/520	NR	12	01	
4601025	0502503	1"	75/130	NR	12	01	
4601027	0502504	1"	110/210	NR	12	01	
4601029	0502506	1"	200/410	NR	12	01	
4601031	0502507	1"	260/520	NR	12	01	
4601035	0503204	1"1/4	110/210	NR	12	01	
4601037	0503206	1"1/4	200/410	NR	12	01	
4601039	0503207	1"1/4	260/520	NR	12	01	
4601041	0504004	1"1/2	110/210	NR	12	01	
4601043	0504006	1"1/2	200/410	NR	12	01	
4601045	0504007	1"1/2	260/520	NR	12	01	
4601049	0505006	2"	200/410	NR	12	01	
4601051	0505007	2"	260/520	NR	12	01	

FLESS. ESTENSIBILE CALDAIA SENZA RIVESTIMENTO

Giunto estensibile in acciaio inox AISI 304 L. spessore > 0,21. Raccordo maschio, canotto, portagirello e dado in acciaio inox AISI 303. Raccordo maschio UNI EN 10226-1, dado ISO 228/1.

DADO ANTITORSIONE



codice	sigla	MF/FG	mm	UM	min. ord. conf.	cat.	prezzo (€)
4602001	0591503	1/2"	75/130	NR	12	01	
4602003	0591504	1/2"	110/210	NR	12	01	
4602005	0591506	1/2"	200/410	NR	12	01	
4602007	0591507	1/2"	260/520	NR	12	01	
4602025	0611500	1/2"	500/1000	NR	12	01	
4602044	0599904	1/2"x3/4"	110/210	NR	12	01	
4602045	0599906	1/2"x3/4"	200/410	NR	12	01	
4602009	0592003	3/4"	75/130	NR	12	01	
4602011	0592004	3/4"	110/210	NR	12	01	
4602013	0592006	3/4"	200/410	NR	12	01	
4602015	0592007	3/4"	260/520	NR	12	01	
4602031	0612000	3/4"	500/1000	NR	12	01	
4602017	0592503	1"	75/130	NR	12	01	
4602019	0592504	1"	110/210	NR	12	01	
4602021	0592506	1"	200/410	NR	12	01	
4602023	0592507	1"	260/520	NR	12	01	

FLESS. ESTENSIBILE CALDAIA SENZA RIVESTIMENTO

Giunto estensibile in acciaio inox AISI 304 spessore > 0,21mm. Canotto portagirello in acciaio inox AISI 303. Dadi in ottone nichelato ISO 228/1.



FLESSIBILE ESTENSIBILE CALDAIA RIVESTITO

Giunto estensibile in acciaio inox spessore > 0,21 mm, guaina esterna materiale termoretraibile in poliolefina reticolata. Raccordo, canotto, portagirello in acciaio inox AISI 303; dado in ottone nichelato. Raccordo maschio UNI EN 10226-1, dado ISO 228/1.



codice	sigla	MF/FG	mm	UM	min. ord. conf.	cat.	prezzo (€)
4600011	0511503	1/2"	90/130	NR	12	02	10,09
4600013	0511504	1/2"	120/210	NR	12	02	11,54
4600015	0511505	1/2"	180/300	NR	12	02	12,74
4600017	0511506	1/2"	240/410	NR	12	02	13,94
4600019	0511507	1/2"	290/520	NR	12	02	15,40
4600042	0519904	1/2"x1/4"	120/210	NR	12	02	14,66
4600044	0519906	1/2"x3/4"	240/410	NR	12	02	19,26
4600021	0512003	3/4"	90/130	NR	12	02	12,77
4600023	0512004	3/4"	120/210	NR	12	02	14,66
4600025	0512005	3/4"	180/300	NR	12	02	17,00
4600027	0512006	3/4"	240/410	NR	12	02	19,26
4600029	0512007	3/4"	290/520	NR	12	02	23,00
4600033	0512504	1"	120/210	NR	12	02	18,91
4600035	0512505	1"	180/300	NR	12	02	22,57
4600037	0512506	1"	240/410	NR	12	02	26,26
4600039	0512507	1"	290/520	NR	12	02	31,26

GIUNTI ANTIVIBRANTI FILETTATI

Giunto inox antivibrante AISI 316L. Per bruciatori, autoclavi, caldaie ecc... Maschio 1/2" e 3/4" in acciaio inox AISI 303. Maschio > 3/4 in acciaio al carbonio. Filettatura UNI EN 10226-1. Flange (DN>2) in acciaio ASTM A105 Gr B con foratura PN10.



codice	sigla	Ø	DN	mm	UM	min. ord. conf.	cat.	prezzo (€)
4730002	0542032	3/4"	20	150	NR	1	02	
4730003	0542533	1"	25	165	NR	1	02	
4730004	0543234	1"1/4	32	180	NR	1	02	
4730005	0544035	1"1/2	40	210	NR	1	02	
4730006	0545036	2"	50	230	NR	1	02	

LEGENDA:
MF = Maschio fisso
FF = Femmina fissa
FG = Femmina Girevole

GIUNTI ESTENSIBILI ED ANTIVIBRANTI GAS E ACQUA

TUBI FLESSIBILI GIUNTI ANTIVIBRANTI

KIT PER CALDAIA A NORMA UNI 11353:2010

COMPOSTO DA: nr.1 flessibile estensibile gas 3/4" (MF)
nr.1 guarnizione in gomma NBR
nr.2 flessibili estensibili acqua 3/4" (MF)
nr.2 flessibili estensibili acqua 1/2" (MF)



codice	sigla	mm	UM	min. ord. conf.	cat.	prezzo (€)
4711001	0800000	180 - 300	NR	1	03	
4711002	0800001	240 - 410	NR	1	03	

KIT PER CALDAIA A NORMA UNI 11353:2010

COMPOSTO DA: n.1 flessibile estensibile gas 3/4" (MF)
nr.1 guarnizione gas in gomma, nr.2 guarnizioni acqua 3/4" e nr.2 guarnizioni acqua 1/2"
nr.2 flessibili estensibili acqua 3/4" (MF)
nr.2 flessibili estensibili acqua 1/2" (MF)

NOVITÀ!



codice	mm	UM	min. ord.	conf.	cat.	prezzo (€)
● 4711012	220 - 420	NR	1	20	03	

KIT PER CALDAIA A NORMA UNI 11353:2010 RIVESTITO

COMPOSTO DA: n.1 flessibile estensibile gas 3/4" (MF)
nr.1 guarnizione gas in gomma, nr.2 guarnizioni acqua 3/4" e nr.2 guarnizioni acqua 1/2"
nr.2 flessibili estensibili acqua 3/4" (MF) RIVESTITI BIANCHI
nr.2 flessibili estensibili acqua 1/2" (MF) RIVESTITI BIANCHI

NOVITÀ!



codice	mm	UM	min. ord.	conf.	cat.	prezzo (€)
● 4711112	200 - 400	NR	1	20	03	

FLESS. NON ESTEN. PER CONTATORI NON RIVESTITO

Giunto non estensibile in acciaio inox AISI 316L spessore > 0,21 mm.
Raccordo, canotto, portagirello in acciaio inox AISI 303. Dado in ottone.
Raccordo maschio e femmina fissa UNI EN 10226-1, dado ISO 228/1.



codice	sigla	Ø	mm	UM	min. ord. conf.	cat.	prezzo (€)
4740001	0562140	3/4" FFx1" FG	160	NR	1	02	
4740002	0562100	3/4" MFx1" FG	160	NR	1	02	
4740003	0562142	3/4" FFx1" FG	200	NR	1	02	
4740009	0563143	3/4" FFx1" 1/4 FG	300	NR	1	02	
4740016	0563303	1" MFx1" 1/4 FG	300	NR	1	02	

GUARNIZIONE IN GOMMA NBR EN549 sp.2,5mm

Per flessibili gas.



codice	sigla	Ø	UM	min. ord. conf.	cat.	prezzo (€)
4744003	0650004	DN15 (1/2")	NR	100	09	
4744004	0650005	DN20 (3/4")	NR	100	09	
4744006	0650006	DN25 (1")	NR	50	09	

GUARNIZIONE IN GOMMA ACRILONITRILE

Per flessibile contatore



codice	sigla	Ø	UM	min. ord. conf.	cat.	prezzo (€)
4744002	0650040	1"	NR	1	09	
4744001	0650030	1" 1/4	NR	1	09	

JOLLY CASA ADATTATORE PER TUBI FLESSIBILI GAS

Passaggio interno D. 13-9,
gommino in acrilonitrile
omologato per metano
GPL e gas manifatturato
(D. 13 per metano
D. 9 per GPL)



codice	sigla	Ø	UM	min. ord. conf.	cat.	prezzo (€)
4744005	0651530	DN15 (1/2")	NR	1	09	

LEGENDA:
MF = Maschio fisso
FF = Femmina fissa
FG = Femmina Girevole

GIUNTI ESTENSIBILI ED ANTIVIBRANTI GAS E ACQUA

TUBO FLESSIBILE CARTELLABILE

TUBO FLESSIBILE CARTELLABILE PER GAS

Tubo corrugato pieghevole in acciaio inox AISI 316L, per gas con rivest. protettivo giallo in LDPE. Temperatura max. 100°C. Pressione max. di esercizio 0,5 bar. Conforme EN 15266:2007



codice	sigla	Ø	lungh. (mt)	UM	min. ord. conf.	cat.	prezzo (€)
4606010	2581205	DN12 - 1/2"	5	RT	1	01	
4606011	2581210	DN12 - 1/2"	10	RT	1	01	
4606015	2581510	DN15 - 3/4"	10	RT	1	01	

TUBO FLESSIBILE CARTELLABILE AISI 304

Tubo corrugato pieghevole in acciaio inox AISI 304 per acqua. Pressione max. di esercizio: 15 bar.



codice	sigla	DN	lungh. (mt)	UM	min. ord. conf.	cat.	prezzo (€)
4606100	5581205	DN12 - 1/2"	5	RT	1	01	
4606101	5581210	DN12 - 1/2"	10	RT	1	01	
4606104	5581505	DN15 - 3/4"	5	RT	1	01	
4606105	5581510	DN15 - 3/4"	10	RT	1	01	

NIPPLE CILINDRICO

Confezione 10 pz.



codice	sigla	Ø	UM	min. ord. conf.	cat.	prezzo (€)
4606310	3581211	DN12 - 1/2"	CF	1	01	
4606311	3581511	DN15 - 3/4"	CF	1	01	

DADO

Confezione 10 pz.



codice	sigla	Ø	UM	min. ord. conf.	cat.	prezzo (€)
4606301	3581201	DN12 - 1/2", Gas	CF	1	01	
4606302	3581501	DN15 - 3/4", Gas	CF	1	01	
4606303	0581215	DN12 - 1/2", Acqua	CF	1	01	
4606304	0583415	DN15 - 3/4", Acqua	CF	1	01	

NIPPLE CILINDRICO / CONICO

Confezione 10 pz.



codice	sigla	Ø	UM	min. ord. conf.	cat.	prezzo (€)
4606313	3581516	DN15 - 3/4"	CF	1	01	

CARTELLATRICE UNIVERSALE EMIFIX - EMIWATER

1/2" - 3/4" - 1"



codice	sigla	descrizione	UM	min. ord. conf.	cat.	prezzo (€)
4606409	0580008	universale	NR	1	01	

DIMA

Compatibile con nuova cartellatrice 4606409.



codice	sigla	descrizione	UM	min. ord. conf.	cat.	prezzo (€)
4606412	0580026	1/2" e 3/4" (per cartellatrice Eurotis)	NR	1	01	
4606410	0580027	1/2" e 3/4" acqua e gas	NR	1	01	
4606411	0580028	1" acqua e gas	NR	1	01	

VALIGETTA PER TUBO CARTELLABILE

COMPOSTO DA:

- nr.1 cartellatrice (4606409)
- nr.1 dima 1/2"-3/4" acqua e gas (4606410)
- nr.1 conf.(10pz) dadi 1/2" acqua (4606303)
- nr.1 conf.(10pz) dadi 3/4" acqua (4606304)
- nr.1 conf.(10pz) dadi 1/2" gas (4606301)
- nr.1 conf.(10pz) dadi 3/4" gas (4606302)



codice	sigla	descrizione	UM	min. ord. conf.	cat.	prezzo (€)
4606401	0580004	1/2" - 3/4"	NR	1	01	

GIUNTI ESTENSIBILI ED ANTIVIBRANTI GAS E ACQUA

TUBI FLESSIBILI INOX E ALLUMINIO

TUBO ALLUMINIO BIANCO

Tubo flessibile ed estensibile fino a 3 metri



codice	sigla	Ø	UM	min. ord. conf.	cat.	prezzo (€)
4655003	0001080	80	MT	3	22	
4655004	0001090	90	MT	3	22	
4655005	0001100	100	MT	3	22	
4655006	0001110	110	MT	3	22	
4655007	0001120	120	MT	3	22	
4655009	0001130	130	MT	3	22	
4655010	0001140	140	MT	3	22	
4655011	0001150	150	MT	3	22	
4655012	0001160	160	MT	3	22	
4655014	0001180	180	MT	3	22	
4655015	0001200	200	MT	3	22	

FASCETTA STRINGITUBO E-FLEX



codice	sigla	Ø	UM	min. ord. conf.	cat.	prezzo (€)
4662002	0075135	60/135	NR	1	02	
4662003	0075170	60/170	NR	1	02	
4662004	0075215	60/215	NR	1	02	
4662005	0075325	60/325	NR	1	02	
4662006	0075525	60/525	NR	1	02	

TUBO ALLUMINIO NATURALE

Tubo flessibile ed estensibile fino a 3 metri



codice	sigla	Ø	UM	min. ord. conf.	cat.	prezzo (€)
4654002	0000075	75	MT	3	22	
4654003	0000080	80	MT	3	22	
4654004	0000090	90	MT	3	22	
4654005	0000100	100	MT	3	22	
4654006	0000110	110	MT	3	22	
4654007	0000120	120	MT	3	22	
4654008	0000125	125	MT	3	22	
4654009	0000130	130	MT	3	22	
4654021	0000135	135	MT	3	22	
4654010	0000140	140	MT	3	22	
4654022	0000145	145	MT	3	22	
4654011	0000150	150	MT	3	22	
4654012	0000160	160	MT	3	22	
4654014	0000180	180	MT	3	22	
4654015	0000200	200	MT	3	22	
4654018	0000250	250	MT	3	22	
4654020	0000300	300	MT	3	22	

FASCETTA STRINGITUBO MIGNON



codice	sigla	Ø	UM	min. ord. conf.	cat.	prezzo (€)
4663001	0072017	10/16	NR	1	02	
4663003	0072024	12/22	NR	1	02	
4663005	0072031	20/32	NR	1	02	
4663006	0072038	25/40	NR	1	02	

TUBO SOLARE

TWIN SOLAR SLIM

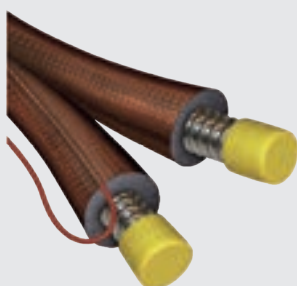

TWIN SOLAR SLIM

Per impianti solari termici. Tubo flessibile in acciaio AISI 316 L con isolamento in gomma di colore rosso coppo, ideale per l'installazione sottotegola/cavedio. Resistente ai raggi UV e alle alte temperature fino a + 150°C, alta resistenza meccanica. Compreso di cavo sensore di temperatura.

DATI TECNICI

GUAINA ISOLANTE		
PROPRIETÀ	VALORE	NORME DI RIFERIMENTO
Temperatura d'impiego	-40°C 150°C	EN 14706 - EN 14707
Conducibilità termica λ W/(m•K)	0°C = 0,040	EN 13787 - EN ISO 8497
Fuoco	Euroclasse E	EN 13501-1

CAVO SENSORE	
PROPRIETÀ	VALORE
Temperatura di esercizio	-60°C 150°C
Rame flessibile (conduttore) \varnothing 1mm	CEI 20-19/15
Tensione nominale	300/500 V
Resistenza elettrica	20.0 Ohm/km
Guaina di rivestimento	gomma siliconica

TUBO FLESSIBILE (ACCIAIO AISI 316 L)			
DIAMETRO	SPESSORE	PRESSIONE MAX D'ESERCIZIO	RAGGIO MINIMO CURVATURA
DN 16	0,18 mm	16 bar	25 mm
DN 20	0,18 mm	10 bar	30 mm
DN 25	0,20 mm	10 bar	35 mm

TWIN SOLAR SLIM IN BOBINE

codice	sigla	sp. (mm)	DN	lung. (mt)	UM	min. ord. conf.	cat.	prezzo (€)
9169050	86TR0M090225002	9	16	50	MT	50	07	
9169100	86TR0M09022A002	9	16	100	MT	100	07	
9169150	86TR0M09022A502	9	16	150	MT	150	07	
9209050	86TR0M090285002	9	20	50	MT	50	07	
9209100	86TR0M09028A002	9	20	100	MT	100	07	
9209150	86TR0M09028A502	9	20	150	MT	150	07	
9259050	86TR0M090355002	9	25	50	MT	50	07	
9259100	86TR0M09035A002	9	25	100	MT	100	07	

TWIN SOLAR SLIM IN ROTOLI

codice	sigla	sp. (mm)	DN	lung. (mt)	UM	min. ord. conf.	cat.	prezzo (€)
9169010	86TR0M090221002	9	16	10	MT	10	07	
9169015	86TR0M090221502	9	16	15	MT	15	07	
9169020	86TR0M090222002	9	16	20	MT	20	07	
9169025	86TR0M090222502	9	16	25	MT	25	07	
9209010	86TR0M090281002	9	20	10	MT	10	07	
9209015	86TR0M090281502	9	20	15	MT	15	07	
9209020	86TR0M090282002	9	20	20	MT	20	07	
9209025	86TR0M090282502	9	20	25	MT	25	07	
9259025	86TR0M090352502	9	25	25	MT	25	07	

ACCESSORI PER TWIN SOLAR SLIM

SBOBINATRICE, DEVOLGITORE



codice	descrizione	foto	UM	min. ord. conf.	cat.	prezzo (€)
850VR020444	sbobinatrice	1	NR	1	02	
850VR020471	devolgitore	2	NR	1	02	

INNESTO DOPPIA CONNESSIONE

Raccordo ad innesto rapido con tenuta meccanica



codice	∅ (mm)	UM	min. ord. conf.	cat.	prezzo (€)
850VR0204651	16x16	NR	8	02	
850VR0204661	20x20	NR	8	02	
850VR0204671	25x25	NR	8	02	

INNESTO MASCHIO

Raccordo ad innesto rapido con tenuta meccanica



codice	∅ (mm)	UM	min. ord. conf.	cat.	prezzo (€)
850VR0204501	1/2"x16	NR	8	02	
850VR0204511	3/4"x16	NR	8	02	
850VR0204521	3/4"x20	NR	8	02	
850VR0204531	1"x20	NR	8	02	
850VR0204541	1"1/4x25	NR	8	02	

INNESTO FEMMINA

Raccordo ad innesto rapido con tenuta meccanica



codice	∅ (mm)	UM	min. ord. conf.	cat.	prezzo (€)
850VR0204551	1/2"x16	NR	8	02	
850VR0204561	3/4"x16	NR	8	02	
850VR0204571	3/4"x20	NR	8	02	
850VR0204581	1"x20	NR	8	02	

ISOLAMENTO SOLARE IN GOMMA

SOLAR HT

Isolante elastomerico per alte temperature
La soluzione razionale per impianti solari e processi industriali fino a 150° C

DATI TECNICI

Limiti temperatura d'impiego	-40°C +150°C
Conducibilità termica λ W/(m•K) [DIN 52613] - EN 12667 (DIN 52612)	+0 °C = 0,040 +40°C = 0,044
Problematiche di corrosione	EN 13468; pH neutro
Fuoco (EN 1305-1)	Euroclasse E

SOLAR R

Rivestito in pellicola di protezione ad alta resistenza ai raggi UV
La soluzione razionale e conveniente per impiantistica solare e processi industriali
Consigliato per impianti solari e linee di vapore a bassa pressione

DATI TECNICI

Limiti temperatura d'impiego	-40°C +150°C
Fuoco (EN 1305-1)	Euroclasse E

TUBO SOLAR HT L.2mt



codice	spessore (mm)	∅ (mm)	UM	min. ord. conf.	cat.	prezzo (€)
13015215526	13	15	MT	112	21	
13018215526	13	18	MT	98	21	
13022215526	13	22	MT	84	21	
13028215526	13	28	MT	64	21	
13035215526	13	35	MT	50	21	
13042215526	13	42	MT	40	21	
19015215526	19	15	MT	64	21	
19018215526	19	18	MT	58	21	
19022215526	19	22	MT	64	21	
19028215526	19	28	MT	48	21	
19035215526	19	35	MT	36	21	
19042215526	19	42	MT	32	21	

TUBO SOLAR R IMBALLO STANDARD L.2mt



codice	spessore (mm)	∅ (mm)	UM	min. ord. conf.	cat.	prezzo (€)
14018217526KR	14	18	MT	98	02	
14022217526KR	14	22	MT	84	02	
20018217526KR	20	18	MT	58	02	
20022217526KR	20	22	MT	50	02	
20028217526KR	20	28	MT	40	02	

ISOLAMENTO IN GOMMA

TUBO ST

TUBO ST L.2mt

DATI TECNICI

Proprietà	Valore	Norme di riferimento	
Limiti d'impiego	-165°C +110°C	EN 14706 - EN14707	
Conducibilità termica λ W/(m•K)	Spessori \leq 25mm	EN 13787 - EN ISO 8497	
	-20 °C = 0,031		Spessori \geq 25mm
	0 °C = 0,033		-20 °C = 0,034
	+20 °C = 0,035		0 °C = 0,036
	+40 °C = 0,037	+20 °C = 0,038	
		+40 °C = 0,040	
Problematiche di corrosione	pH neutro (7 \pm 0,5)	EN 13468	
Permeabilità μ	\geq 10000	\geq 7000	EN 12086
Fuoco	EUROCLASSE B1-s2,d0	EN 13501-1	



codice	sigla	spessore (mm)	\emptyset (mm)	UM	min. ord. conf.	cat.	prezzo (€)
9060120	06012005508	6	12	MT	316	18	
9060150	06015005508	6	15	MT	266	18	
9060180	06018005508	6	18	MT	220	18	
9060200	06020005508	6	20	MT	180	18	
9060220	06022005508	6	22	MT	180	18	
9060250	06025005508	6	25	MT	152	18	
9060280	06028005508	6	28	MT	130	18	
9060350	06035005508	6	35	MT	100	18	
9060420	06042005508	6	42	MT	90	18	
9090100	09010005508	9	10	MT	266	18	
9090120	09012005508	9	12	MT	234	18	
9090150	09015005508	9	15	MT	192	18	
9090180	09018005508	9	18	MT	166	18	
9090200	09020005508	9	20	MT	136	18	
9090220	09022005508	9	22	MT	136	18	
9090250	09025005508	9	25	MT	108	18	
9090280	09028005508	9	28	MT	98	18	
9090350	09035005508	9	35	MT	76	18	
9090420	09042005508	9	42	MT	60	18	
9090480	09048005508	9	48	MT	50	18	
9090540	09054005508	9	54	MT	46	18	
9090600	09060005508	9	60	MT	46	18	
9090760	09076005508	9	76	MT	40	18	
9090890	09089005508	9	89	MT	36	18	
9091140	09114005508	9	114	MT	22	18	
9130120	13012005508	13	12	MT	162	18	
9130150	13015005508	13	15	MT	136	18	
9130180	13018005508	13	18	MT	118	18	
9130220	13022005508	13	22	MT	98	18	
9130250	13025005508	13	25	MT	80	18	
9130280	13028005508	13	28	MT	78	18	
9130350	13035005508	13	35	MT	58	18	
9130420	13042005508	13	42	MT	48	18	
9130480	13048005508	13	48	MT	40	18	
9130540	13054005508	13	54	MT	34	18	
9130600	13060005508	13	60	MT	32	18	
9130640	13064005508	13	64	MT	30	18	
9130760	13076005508	13	76	MT	26	18	
9130890	13089005508	13	89	MT	24	18	
9131140	13114005508	13	114	MT	16	18	
9131250	13125005508	13	125	MT	12	18	
9190150	19015005508	19	15	MT	78	18	
9190180	19018005508	19	18	MT	72	18	
9190200	19020005508	19	20	MT	66	18	
9190220	19022005508	19	22	MT	64	18	
9190250	19025005508	19	25	MT	50	18	
9190280	19028005508	19	28	MT	48	18	
9190320	19032005508	19	32	MT	36	18	
9190350	19035005508	19	35	MT	36	18	
9190420	19042005508	19	42	MT	32	18	
9190480	19048005508	19	48	MT	24	18	

TUBO ST L.2mt

codice	sigla	spessore (mm)	Ø (mm)	UM	min. ord. conf.	cat.	prezzo (€)
9190540	19054005508	19	54	MT	24	18	
9190600	19060005508	19	60	MT	22	18	
9190640	19064005508	19	64	MT	18	18	
9190760	19076005508	19	76	MT	18	18	
9190890	19089005508	19	89	MT	14	18	
9191140	19114005508	19	114	MT	12	18	
9191250	19125005508	19	125	MT	10	18	
9250220	25022005508	25	22	MT	42	18	
9250280	25028005508	25	28	MT	40	18	
9250350	25035005508	25	35	MT	24	18	
9250420	25042005508	25	42	MT	22	18	
9250480	25048005508	25	48	MT	18	18	
9250540	25054005508	25	54	MT	16	18	
9250600	25060005508	25	60	MT	12	18	
9250760	25076005508	25	76	MT	10	18	
9250890	25089005508	25	89	MT	8	18	
9251140	25114005508	25	114	MT	6	18	
9320280	32028005508	32	28	MT	24	18	
9320350	32035005508	32	35	MT	22	18	
9320420	32042005508	32	42	MT	16	18	
9320480	32048005508	32	48	MT	14	18	
9320540	32054005508	32	54	MT	12	18	
9320600	32060005508	32	60	MT	10	18	
9320640	32064005508	32	64	MT	10	18	
9320760	32076005508	32	76	MT	8	18	
9320890	32089005508	32	89	MT	8	18	
9321140	32114005508	32	114	MT	6	18	
9400420	40042005508	40	42	MT	16	18	
9400480	40048005508	40	48	MT	12	18	
9400540	40054005508	40	54	MT	10	18	
9950600	50060005508	50	60	MT	8	18	
9950760	50076005508	50	76	MT	6	18	
9500890	50089005508	50	89	MT	6	18	
9601140	60114005508	60	114	MT	2	18	

LASTRA ST IN ROTOLI h.1mt, NON ADESIVA

DATI TECNICI			
Proprietà	Valore		Norme di riferimento
Limiti d'impiego	da -165°C +85°C		EN 14706 - EN14707
Conducibilità termica λ W/(m•K)	Spessori ≤ 25mm	Spessori ≥ 25mm	EN 13787 - EN 12667
	-20 °C = 0,031 0 °C = 0,033 +20 °C = 0,035 +40 °C = 0,037	-20 °C = 0,034 0 °C = 0,036 +20 °C = 0,038 +40 °C = 0,040	
Problematiche di corrosione	pH neutro (7±0,5)		EN 13468
Permeabilità μ	≥ 10000	≥ 7000	EN 12086
Fuoco	EUROCLASSE B _L -s3,d0		EN 13501-1



codice	spessore (mm)	rotolo	UM	min. ord. conf.	cat.	prezzo (€)
80010210107S	10	20m ²	MQ	20	18	
80013210107S	13	14m ²	MQ	14	18	
80019210107S	19	10m ²	MQ	10	18	
80025210107S	25	8m ²	MQ	8	18	
80032210107S	32	6m ²	MQ	6	18	

ISOLAMENTO IN GOMMA

ACCESSORI ISOLAMENTO IN GOMMA

COLLA K 414



codice	Latta	UM	min. ord.	conf.	cat.	prezzo (€)
● 2006350	0,5lt	NR	1	20	19	

NASTRO ADESIVO ANTICONDENSA

In elastomero



codice	spess. (mm)	altezza (mm)	lungh. (mt)	UM	min. ord. conf.	cat.	prezzo (€)
● 2006341	3	50	10	NR	24	19	
● 2006340	3	50	15	NR	12	19	

ISOLAMENTO IN POLIETILENE

FONOMETAL

GUAINA FONOMETAL IN ROTOLI 15 mt colore BLU

Guaina isolante in polietilene espanso a cellule chiuse dello spessore 5 mm che, avvolgendo esternamente gli scarichi, riduce il livello di rumorosità molto al di sotto dei 35 dB richiesti dalla legge.



DATI TECNICI

Temperatura d'impiego	fino a -90°C
Conducibilità termica	+10°C = 0,038 W/(m x K) +40°C = 0,040 W/(m x K)
Comportamento al fuoco	Classe E _L

codice	sigla	spessore (mm)	Ø	UM	min. ord. conf.	cat.	prezzo (€)
9310002	050502185PE0CB	5	50	NR	135	09	
9310004	050752185PE0CB	5	75	NR	90	09	
9310005	050802185PE0CB	5	80	NR	90	09	
9310006	050902185PE0CB	5	90	NR	75	09	
9310007	051002185PE0CB	5	100	NR	75	09	
9310008	051102185PE0CB	5	110	NR	75	09	
9310009	051252185PE0CB	5	125	NR	60	09	

TUBO POLAR IN BARRE L. 2mt

Tubo isolante in polietilene espanso. Indicato per impianti di condizionamento, riscaldamento e refrigerazione.

DATI TECNICI

Temperatura d'impiego	-45 °C +100 °C	
Peso Specifico	30÷35 Kg/m ³ tolleranza ±10%	
Coefficiente di conducibilità termica DIN 52613	a +40 °C = 0,035 W/ (m x K)	
Permeabilità al vapore DIN 52615 PR. EN 13469	ottima	μ 10.000
Resistenza all'ozono	ottima	
Resistenza alle muffe e agli insetti	ottima	
Tossicità	Non sprigiona fumi tossici e opachi	Certificazioni N. 003/CF/T98 N. 002/CF/T98
Comportamento al fuoco	Classe B ₁ -s1, dØ certificato CE di conformità N. 0497/CDP/4697/12	
Non contiene CFC (freon)	Legge N. 549 del 28/12/93	



codice	spessore (mm)	Ø (mm)	UM	min. ord. conf.	cat.	prezzo (€)
099060120	6	12	MT	360	20	
099060140	6	14	MT	320	20	
099060160	6	15/16	MT	284	20	
099060180	6	18	MT	240	20	
099060200	6	20	MT	220	20	
099060220	6	22	MT	194	20	
099060250	6	25	MT	160	20	
099060270	6	27	MT	140	20	
099060280	6	28	MT	134	20	
099060320	6	32	MT	120	20	
099060340	6	34	MT	110	20	
099060350	6	35	MT	104	20	
099060420	6	42	MT	80	20	
099100180	10	18	MT	160	20	
099100200	10	20	MT	150	20	
099100220	10	22	MT	134	20	
099100250	10	25	MT	120	20	
099100270	10	27	MT	94	20	
099100280	10	28	MT	90	20	
099100320	10	32	MT	90	20	
099100340	10	34	MT	84	20	
099100350	10	35	MT	84	20	
099100420	10	42	MT	60	20	
099100480	10	48	MT	50	20	
099100540	10	54	MT	40	20	
099100600	10	60	MT	36	20	
099100760	10	76	MT	24	20	
099100880	10	88	MT	20	20	

codice	spessore (mm)	Ø (mm)	UM	min. ord. conf.	cat.	prezzo (€)
099150180	15	18	MT	100	20	
099150220	15	22	MT	82	20	
099150280	15	28	MT	68	20	
099150350	15	35	MT	60	20	
099150420	15	42	MT	50	20	
099150480	15	48	MT	40	20	
099150540	15	54	MT	30	20	
099150600	15	60	MT	24	20	
099150760	15	76	MT	18	20	
099150880	15	88	MT	18	20	
099151140	15	114	MT	10	20	
099200220	20	22	MT	60	20	
099200280	20	28	MT	50	20	
099200350	20	35	MT	40	20	
099200420	20	42	MT	34	20	
099200480	20	48	MT	30	20	
099200600	20	60	MT	24	20	
099200760	20	76	MT	16	20	
099200880	20	88	MT	12	20	
099201140	20	114	MT	8	20	

ISOLAMENTO IN POLIETILENE

ISOFORM R

TUBO ISOFORM R CON PELLICOLA

Tubo isolante flessibile in polietilene espanso a cellule chiuse con pellicola antigraffio. Indicato per impianti di riscaldamento e condizionamento d'aria.

DATI TECNICI

Temperatura d'impiego	-45 °C +100 °C	
Peso Specifico	30÷35 Kg/m ³ tolleranza ±10%	
Coefficiente di conducibilità termica DIN 52613	a +40 °C = 0,040 W/ (m x K)	
Permeabilità al vapore DIN 52615 PR. EN 13469	ottima	μ 3.500
Resistenza all'ozono	ottima	
Resistenza alle muffe e agli insetti	ottima	
Tossicità	Certificazioni inerenti alla tossicità e opacità dei fumi	N. 100/CF/T/97 16/01/98 N. 101/CF/T/97 16/01/98
Comportamento al fuoco	Classe B ₁ -s1, d0 certificato CE di conformità N. 0497/CDP/4695/12	
Non contiene CFC (freon)	Legge N. 549 del 28/12/93	



codice	spessore (mm)	Ø (mm)	UM	min. ord. conf.	cat.	prezzo (€)
02206012P	6	12	MT	360	20	
02206014P	6	14	MT	320	20	
02206016P	6	15/16	MT	284	20	
02206018P	6	18	MT	240	20	
02206020P	6	20	MT	220	20	
02206022P	6	22	MT	194	20	
02206025P	6	25	MT	160	20	
02206027P	6	27/28	MT	136	20	
02206034P	6	34/35	MT	106	20	
02206042P	6	42	MT	80	20	

codice	spessore (mm)	Ø (mm)	UM	min. ord. conf.	cat.	prezzo (€)
022100220	10	22	MT	260	20	
022100270	10	27/28	MT	220	20	
022100340	10	34/35	MT	170	20	
022100420	10	42	MT	126	20	
022100480	10	48	MT	112	20	
022100540	10	54	MT	90	20	
022100600	10	60	MT	80	20	
022100760	10	76	MT	56	20	
022100880	10	88	MT	40	20	

FASCIA PERIMETRALE

FASCIA PERIMETRALE ADESIVA CON BANDELLA, ROTOLO 50mt

Totalmente adesiva, di colore blu, in polietilene espanso elasticizzato chimico compatto a cellule chiuse.

DATI TECNICI

Temperatura massima d'esercizio (°C)	-20° +80°
Coefficiente di conducibilità termica (W/mK)	a 10° = 0,035 a 40° = 0,039
Isolamento al calpestio (dB) UNI EN ISO 140/6	da 20 a 25,5
Sollecitazione a compressione al 10% di deformazione (kPa)	13,002
Rigidità dinamica (MN/m ³)	41,0



codice	spessore (mm)	altezza (mm)	descrizione	UM	min. ord. conf.	cat.	prezzo (€)
6850001	8	150	5 pretagli	MT	1500	06	
6850002	8	150	senza pretagli	MT	1500	06	

ISOPIU'

DATI TECNICI

Temperatura d'impiego	-30 °C +130 °C
Densità	23 ± 28 Kg/m ³ tolleranza ±10%
Coefficiente di conducibilità termica	a +40 °C = 0,029 W/ (m x K)
Resistenza al fuoco della coppella con rivestimento in alluminio	Classe B _L -s1, dØ certificato CE di conformità N. 0497/CDP/4731/12
Resistenza al fuoco della coppella con rivestimento in PVC	Classe E _L certificato CE di conformità N. DE/4732/12
Stabilità dimensionale sulla lunghezza	% -0,001 a -25 °C / % -0,002 a +40 °C
Non contiene né freon né amianto	LeggeN. 549 del 28/12/93

TUBO ISOPIÙ RIVESTIMENTO PVC L. 2mt

Tubo in poliuretano espanso rivestito in PVC a chiusura autoadesiva



CURVA ISOPIÙ RIVESTIMENTO PVC

Curva in poliuretano espanso rivestito in PVC. Raggio della curvatura adatto per curve a saldare.



codice	spessore (mm)	Ø	UM	min. ord. conf.	cat.	prezzo (€)
PN0200220	20	22	MT	144	09	
PN0200270	20	27	MT	112	09	
PN0200340	20	34	MT	90	09	
PN0200420	20	42	MT	70	09	
PN0250480	25	48	MT	60	09	
PN0250600	25	60	MT	40	09	
PN0300760	30	76	MT	24	09	
PN0300880	30	88	MT	22	09	
PN0401140	40	114	MT	12	09	

codice	spessore (mm)	Ø	UM	min. ord. conf.	cat.	prezzo (€)
PNC200220	20	22	NR	30	09	
PNC200270	20	27	NR	30	09	
PNC200340	20	34	NR	30	09	
PNC200420	20	42	NR	20	09	
PNC250480	25	48	NR	20	09	
PNC250600	25	60	NR	15	09	
PNC300760	30	76	NR	15	09	
PNC300880	30	88	NR	15	09	
PNC401140	40	114	NR	10	09	

FOGLIA PVC IN ROTOLI

Spessore 23-27 micron.



codice	misura (mt)	UM	min. ord. conf.	cat.	prezzo (€)
066ISO2500	1 x 25	MQ	25	09	

CATALOGO
LISTINO N° 6

**INDICE
PER CODICE
ARTICOLO**



INDICE PER CODICE ARTICOLO

codice	UM	cat.	euro	pag.	codice	UM	cat.	euro	pag.	codice	UM	cat.	euro	pag.
02206012P	MT	20		308	099100340	MT	20		307	1011007	NR	09		248
02206014P	MT	20		308	099100350	MT	20		307	1011008	NR	09		248
02206016P	MT	20		308	099100420	MT	20		307	1012002	NR	09		248
02206018P	MT	20		308	099100480	MT	20		307	1012003	NR	09		248
02206020P	MT	20		308	099100540	MT	20		307	1012004	NR	09		248
02206022P	MT	20		308	099100600	MT	20		307	1012005	NR	09		248
02206025P	MT	20		308	099100760	MT	20		307	1021001	NR	09		248
02206027P	MT	20		308	099100880	MT	20		307	1021002	NR	09		248
02206034P	MT	20		308	099150180	MT	20		307	1021004	NR	09		248
02206042P	MT	20		308	099150220	MT	20		307	1021006	NR	09		248
022100220	MT	20		308	099150280	MT	20		307	1031009	NR	09		248
022100270	MT	20		308	099150350	MT	20		307	1031010	NR	09		248
022100340	MT	20		308	099150420	MT	20		307	1031011	NR	09		248
022100420	MT	20		308	099150480	MT	20		307	1031012	NR	09		248
022100480	MT	20		308	099150540	MT	20		307	1041002	NR	09		248
022100540	MT	20		308	099150600	MT	20		307	1041003	NR	09		248
022100600	MT	20		308	099150760	MT	20		307	1101003	NR	03		249
022100760	MT	20		308	099150880	MT	20		307	1101103	NR	03		249
022100880	MT	20		308	099151140	MT	20		307	1111003	NR	03		249
066ISO2500	MQ	09		309	099200220	MT	20		307	1111103	NR	03		249
07146000	NR	10		59	099200280	MT	20		307	1112001	NR	03		249
07147000	NR	10		59	099200350	MT	20		307	1112003	NR	03		249
099060120	MT	20		307	099200420	MT	20		307	1112101	NR	03		249
099060140	MT	20		307	099200480	MT	20		307	1112103	NR	03		249
099060160	MT	20		307	099200600	MT	20		307	1121001	NR	03		249
099060180	MT	20		307	099200760	MT	20		307	115556	NR	13		45
099060200	MT	20		307	099200880	MT	20		307	1201001	NR	09		249
099060220	MT	20		307	099201140	MT	20		307	1201002	NR	09		249
099060250	MT	20		307	1001004	NR	09		248	1201003	NR	09		249
099060270	MT	20		307	1001005	NR	09		248	1202002	NR	09		249
099060280	MT	20		307	1001006	NR	09		248	1203001	NR	09		249
099060320	MT	20		307	1002004	NR	09		248	1203002	NR	09		249
099060340	MT	20		307	1002005	NR	09		248	1203003	NR	09		249
099060350	MT	20		307	1002006	NR	09		248	1204001	NR	09		249
099060420	MT	20		307	1002007	NR	09		248	1204002	NR	09		249
099100180	MT	20		307	1002008	NR	09		248	1207101	NR	05		203
099100200	MT	20		307	1003005	NR	09		248	1207102	NR	05		203
099100220	MT	20		307	1003006	NR	09		248	1207111	NR	05		203
099100250	MT	20		307	1004003	NR	09		248	1207112	NR	05		203
099100270	MT	20		307	1004004	NR	09		248	1207121	NR	05		203
099100280	MT	20		307	1011003	NR	09		248	1207134	NR	05		204
099100320	MT	20		307	1011004	NR	09		248	1207135	NR	05		204

INDICE PER CODICE ARTICOLO

codice	UM	cat.	euro	pag.	codice	UM	cat.	euro	pag.	codice	UM	cat.	euro	pag.
1207136	NR	05		204	1401014	NR	02		111	1403063	NR	06		98
1207151	NR	11		204	1401019	NR	02		111	1403064	NR	06		97
1207152	NR	11		204	1401020	NR	02		109	1403065	NR	06		97
1207153	NR	11		204	1401021	NR	23		112	1403066	NR	06		98
1207154	NR	11		204	1401022	NR	02		111	1403068	NR	06		97
1207155	NR	11		204	1401024	NR	02		111	1403080	NR	05		95
1207159	NR	11		204	1401027	NR	02		110-129	1403081	NR	05		96
13015215526	MT	21		303	1401033	NR	02		110-129	1403083	NR	06		98
13018215526	MT	21		303	1401034	NR	02		110-129	1403084	NR	06		97
13022215526	MT	21		303	14018217526KR	MT	02		303	1403085	NR	15		96
13028215526	MT	21		303	14022217526KR	MT	02		303	1403086	NR	15		96
13035215526	MT	21		303	1403006	NR	02		99	1403918	NR	01		95
13042215526	MT	21		303	1403009	NR	06		99	1403921	NR	01		95
1311001	NR	01		91	1403017	NR	02		99	1403952	NR	01		95
1316001	NR	01		90	1403018	NR	01		95	1403957	NR	01		95
1319001	NR	01		90	1403020	NR	01		95	1404011	NR	02		113
1319801	NR	01		90	1403021	NR	01		95	1405001	NR	02		100
1319901	NR	01		90	1403024	NR	01		95	1405004	NR	06		100
1320001	NR	01		91	1403033	NR	06		98	1405005	NR	06		100
1321001	NR	01		91	1403034	NR	06		98	1405006	NR	02		100
1322001	NR	01		92	1403035	NR	06		97	1405007	NR	02		100
1323001	NR	01		90	1403037	NR	01		95	1405011	NR	02		101
1350639	NR	04		86	1403040	NR	02		99	1405013	NR	02		101
1350649	NR	04		89	1403041	NR	06		97	1405014	NR	02		101
1350659	NR	04		88	1403042	NR	01		95	1405017	NR	02		101
1350902	NR	05		81	1403046	NR	02		98	1405018	NR	02		101
1350903	NR	05		79	1403047	NR	02		98	1405019	NR	02		100
1350907	NR	05		84	1403048	NR	06		99	1405021	NR	06		100
1350908	NR	05		85	1403049	NR	02		99	1405024	NR	02		100
1350912	NR	05		78	1403050	NR	02		96	1405035	NR	02		100
1350913	NR	05		80	1403051	NR	02		96	1405036	NR	02		101
1350917	NR	05		83	1403052	NR	01		95	1405037	NR	02		101
1350918	NR	05		82	1403053	NR	06		98	1405038	NR	02		101
1358639	NR	04		87	1403054	NR	06		97	1405806	NR	02		100
1359639	NR	04		87	1403055	NR	06		98	1405811	NR	02		101
1401004	NR	02		109	1403056	NR	06		97	1405817	NR	02		101
1401005	NR	02		109	1403057	NR	01		95	1405835	NR	02		100
1401009	NR	02		109	1403058	NR	06		98	1405906	NR	02		100
1401010	NR	02		110-129	1403059	NR	06		97	1405911	NR	02		101
1401011	NR	02		110	1403060	NR	01		95	1405917	NR	02		101
1401012	NR	06		111	1403061	NR	02		97	1405935	NR	02		100
1401013	NR	02		111	1403062	NR	02		97	1406003	NR	15		112

INDICE PER CODICE ARTICOLO

codice	UM	cat.	euro	pag.	codice	UM	cat.	euro	pag.	codice	UM	cat.	euro	pag.
1406004	NR	15		112	1410025	NR	06		103	1431818	NR	03		75
1406011	NR	15		112	1410028	NR	06		102	1431915	NR	03		77
1406015	NR	15		112	1410030	NR	06		102	1431916	NR	03		76
1406023	NR	15		112	1410034	NR	06		102	1431918	NR	03		75
1406024	NR	15		112	1410036	NR	06		104	1434001	NR	03		48
1406030	NR	09		60	1411003	NR	02		113	1434007	NR	03		49
1406803	NR	15		112	1411004	NR	02		113	1434013	NR	03		51
1406903	NR	15		112	1411007	NR	02		113	1501004	NR	01		264
1407003	NR	15		112	1412001	NR	06		104	1501005	NR	01		264
1407006	NR	15		112	1412002	NR	06		104	1501006	NR	01		264
1407012	NR	15		112	1412003	NR	06		64-104	1501107	NR	01		264
1407013	NR	15		112	1412004	NR	02		108	1502000	NR	01		264
1407014	NR	06		112	1412008	NR	06		104	1502001	NR	04		264
1409002	NR	02		107	1412009	NR	06		104	1502002	NR	04		264
1409004	NR	02		106	1412012	NR	02		109	1502003	NR	04		264
1409005	NR	02		106	1412013	NR	02		109	1502004	NR	01		264
1409007	NR	02		107	1412014	NR	02		108	1502201	NR	05		269
1409008	NR	02		106	1412015	NR	02		108	1502202	NR	05		269
1409009	NR	02		108	1412016	NR	02		107	1502203	NR	05		269
1409010	NR	02		105	1412808	NR	06		104	1503001	NR	01		264
1409011	NR	02		106	1412908	NR	06		104	1503003	NR	01		264
1409012	NR	02		105	1413028	NR	02		64	1503004	NR	01		264
1409013	NR	02		106	1413029	NR	09		65	1504004	NR	01		264
1409014	NR	02		107	1413069	NR	09		65	1504005	NR	01		264
1409021	NR	02		105	1413084	NR	09		60	1504006	NR	01		264
1409022	NR	02		105	1413085	NR	09		60	1504107	NR	01		264
1409024	NR	02		107	1413086	NR	09		60	1505000	NR	01		264
1409025	NR	02		107	1413089	NR	09		60	1505001	NR	04		264
1409808	NR	02		106	1413091	NR	09		60	1505002	NR	04		264
1409809	NR	02		108	1414009	NR	02		113	1505003	NR	04		264
1409810	NR	02		105	1414012	NR	02		113	1505004	NR	01		264
1409812	NR	02		105	1414016	NR	02		113	1505201	NR	05		269
1409908	NR	02		106	1430007	NR	03		77	1505202	NR	05		269
1409909	NR	02		108	1431014	NR	03		77	1505203	NR	05		269
1409910	NR	02		105	1431015	NR	03		77	1508001	NR	01		268
1409912	NR	02		105	1431016	NR	03		76	1508002	NR	01		268
1410002	NR	06		102	1431017	NR	03		77	1508003	NR	01		268
1410003	NR	06		102	1431018	NR	03		75	1509001	NR	01		268
1410019	NR	06		103	1431021	NR	03		76	1509002	NR	01		268
1410021	NR	06		103	1431024	NR	03		76	1509003	NR	01		268
1410023	NR	06		102	1431815	NR	03		77	1510000	NR	01		268
1410024	NR	06		103	1431816	NR	03		76	1510001	NR	05		268

INDICE PER CODICE ARTICOLO

codice	UM	cat.	euro	pag.	codice	UM	cat.	euro	pag.	codice	UM	cat.	euro	pag.
1510002	NR	05		268	1515003	NR	01		265	1520003	NR	01		266
1510003	NR	05		268	1515104	NR	01		265	1520004	NR	01		266
1510004	NR	01		268	1515105	NR	01		265	1520005	NR	01		266
1510005	NR	01		268	1515106	NR	01		265	1520006	NR	01		266
1510006	NR	01		268	1516001	NR	01		265	1520007	NR	01		266
1510201	NR	05		269	1516002	NR	01		265	1520009	NR	01		266
1510202	NR	05		269	1516003	NR	01		265	1520010	NR	01		266
1510203	NR	05		269	1516004	NR	01		265	1520011	NR	01		266
1511001	NR	05		268	1516005	NR	01		265	1520012	NR	01		266
1511002	NR	05		268	1516006	NR	01		265	1520013	NR	01		266
1511003	NR	05		268	1516007	NR	01		265	1520014	NR	01		266
1511004	NR	01		268	1516008	NR	01		265	1520018	NR	01		266
1511005	NR	01		268	1516201	NR	05		269	1520116	NR	01		266
1511006	NR	01		268	1516202	NR	05		269	1520201	NR	05		269
1511007	NR	01		268	1516203	NR	05		269	1520202	NR	05		269
1512004	NR	01		264	1517001	NR	01		265	1520203	NR	05		269
1512005	NR	01		264	1517002	NR	01		265	1520204	NR	05		269
1512006	NR	01		264	1517003	NR	01		265	1521001	NR	01		266
1512107	NR	01		264	1517004	NR	01		265	1521002	NR	01		266
1513000	NR	01		264	1517005	NR	01		265	1521003	NR	01		266
1513001	NR	04		264	1517007	NR	01		265	1521004	NR	01		266
1513002	NR	04		264	1517009	NR	01		265	1521005	NR	01		266
1513003	NR	04		264	1517011	NR	01		265	1521203	NR	05		270
1513004	NR	01		264	1517202	NR	05		269	1521204	NR	05		270
1513201	NR	05		269	1517203	NR	05		269	1521205	NR	05		270
1513202	NR	05		269	1517204	NR	05		269	1521206	NR	05		270
1513203	NR	05		269	1518004	NR	01		265	1522000	NR	01		266
1514000	NR	01		264	1518005	NR	01		265	1522001	NR	01		266
1514001	NR	01		264	1518006	NR	01		265	1522002	NR	01		266
1514002	NR	01		264	1518010	NR	01		265	1522003	NR	01		266
1514003	NR	01		264	1518011	NR	01		265	1522004	NR	01		266
1514005	NR	01		264	1518107	NR	01		265	1522005	NR	01		266
1514006	NR	01		264	1519001	NR	04		265	1522006	NR	01		266
1514007	NR	01		264	1519002	NR	04		265	1522007	NR	01		266
1514009	NR	01		264	1519003	NR	04		265	1522201	NR	05		270
1514010	NR	01		264	1519200	NR	05		269	1522202	NR	05		270
1514011	NR	01		264	1519201	NR	05		269	1522203	NR	05		270
1514012	NR	01		264	1519202	NR	05		269	1523001	NR	01		266
1514013	NR	01		264	1519203	NR	05		269	1523002	NR	01		266
1514014	NR	01		264	1520000	NR	01		266	1523003	NR	01		266
1515001	NR	01		265	1520001	NR	01		266	1523007	NR	01		266
1515002	NR	01		265	1520002	NR	01		266	1523104	NR	01		266

INDICE PER CODICE ARTICOLO

codice	UM	cat.	euro	pag.	codice	UM	cat.	euro	pag.	codice	UM	cat.	euro	pag.
1523105	NR	01		266	1526302	NR	05		270	1532001	NR	01		267
1523106	NR	01		266	1526304	NR	05		270	1532002	NR	01		267
1525000	NR	01		265	1526305	NR	05		270	1532003	NR	01		267
1525001	NR	01		265	1526306	NR	05		270	1532004	NR	01		267
1525002	NR	01		265	1526307	NR	05		270	1532005	NR	01		267
1525003	NR	01		265	1526308	NR	05		270	1532009	NR	01		267
1525004	NR	01		265	1526309	NR	05		270	1532011	NR	01		267
1525005	NR	01		265	1526310	NR	05		270	1532012	NR	01		267
1525006	NR	01		265	1526311	NR	05		270	1532013	NR	01		267
1525007	NR	01		265	1526312	NR	05		270	1532014	NR	01		267
1525008	NR	01		265	1527300	NR	05		270	1532015	NR	01		267
1525009	NR	01		265	1527302	NR	05		270	1532016	NR	01		267
1525010	NR	01		265	1527306	NR	05		270	1532017	NR	01		267
1525011	NR	01		265	1527307	NR	05		270	1532018	NR	01		267
1525012	NR	01		265	1528001	NR	01		267	1532019	NR	01		267
1525013	NR	01		265	1528002	NR	01		267	1532021	NR	01		267
1525014	NR	01		265	1528003	NR	01		267	1532022	NR	01		267
1525015	NR	01		265	1528004	NR	01		267	1532023	NR	01		267
1525016	NR	01		265	1528105	NR	01		267	1532024	NR	01		267
1525020	NR	01		265	1529001	NR	21		275	1532025	NR	01		267
1525021	NR	01		265	1529002	NR	21		275	1532026	NR	01		267
1525022	NR	01		265	1529003	NR	21		275	1532027	NR	01		267
1525024	NR	01		265	1529004	NR	21		275	1532028	NR	01		267
1525025	NR	01		265	1529005	NR	21		275	1532029	NR	01		267
1525027	NR	01		265	1529006	NR	21		275	1532030	NR	01		267
1525028	NR	01		265	1529007	NR	21		275	1532031	NR	01		267
1525123	NR	01		265	1529008	NR	21		275	1532032	NR	01		267
1525201	NR	05		270	1530001	NR	21		275	1532033	NR	01		267
1525202	NR	05		270	1530002	NR	21		275	1532034	NR	01		267
1525203	NR	05		270	1530003	NR	21		275	1532211	NR	05		270
1525204	NR	05		270	1530004	NR	21		275	1532212	NR	05		270
1525205	NR	05		270	1530005	NR	21		275	1532214	NR	05		270
1525207	NR	05		270	1530006	NR	21		275	1532215	NR	05		270
1525208	NR	05		270	1530009	NR	21		275	1532216	NR	05		270
1525209	NR	05		270	1531101	NR	21		276	1532217	NR	05		270
1525210	NR	05		270	1531102	NR	21		276	1532221	NR	05		270
1525211	NR	05		270	1531103	NR	21		276	1533001	NR	01		267
1525213	NR	05		270	1531104	NR	21		276	1533002	NR	01		267
1525214	NR	05		270	1531105	NR	21		276	1533003	NR	01		267
1525215	NR	05		270	1531106	NR	21		276	1533004	NR	01		267
1525216	NR	05		270	1531107	NR	21		276	1533201	NR	05		270
1526301	NR	05		270	1531108	NR	21		276	1533202	NR	05		270

INDICE PER CODICE ARTICOLO

codice	UM	cat.	euro	pag.	codice	UM	cat.	euro	pag.	codice	UM	cat.	euro	pag.
1533203	NR	05		270	1535023	NR	01		267	1545005	NR	01		268
1533204	NR	05		270	1535025	NR	01		267	1546001	NR	01		268
1533206	NR	05		270	1535026	NR	01		267	1546002	NR	01		268
1534000	NR	01		267	1535029	NR	01		267	1546003	NR	01		268
1534001	NR	01		267	1535031	NR	01		267	1546004	NR	01		268
1534002	NR	01		267	1535035	NR	01		267	1546005	NR	01		268
1534003	NR	01		267	1535037	NR	01		267	1546006	NR	01		268
1534004	NR	01		267	1535038	NR	01		267	1550001	NR	01		266
1534005	NR	01		267	1536001	NR	21		276	1550002	NR	01		266
1534006	NR	01		267	1537000	NR	01		266	1560001	NR	06		203
1534007	NR	01		267	1537001	NR	01		266	1560002	NR	06		203
1534008	NR	01		267	1537002	NR	01		266	1601000	NR	01		262
1534009	NR	01		267	1537003	NR	01		266	1601001	NR	01		262
1534010	NR	01		267	1537004	NR	01		266	1601002	NR	01		262
1534201	NR	05		270	1537005	NR	01		266	1601003	NR	01		262
1534202	NR	05		270	1537006	NR	01		266	1601004	NR	01		262
1534203	NR	05		270	1537007	NR	01		266	1602000	NR	01		262
1534204	NR	05		270	1540000	NR	04		276	1602001	NR	01		262
1534211	NR	05		270	1540001	NR	04		276	1602002	NR	01		262
1534212	NR	05		270	1540002	NR	04		276	1602003	NR	01		262
1535000	NR	01		267	1540003	NR	04		276	1602004	NR	01		262
1535001	NR	01		267	1540004	NR	04		276	1603000	NR	01		262
1535002	NR	01		267	1540005	NR	04		276	1603001	NR	01		262
1535003	NR	01		267	1540006	NR	04		276	1603002	NR	01		262
1535004	NR	01		267	1541001	NR	04		276	1603003	NR	01		262
1535005	NR	01		267	1541002	NR	04		276	1603004	NR	01		262
1535006	NR	01		267	1541003	NR	04		276	1604001	NR	01		262
1535008	NR	01		267	1541004	NR	04		276	1604002	NR	01		262
1535009	NR	01		267	1541005	NR	04		276	1604003	NR	01		262
1535010	NR	01		267	1541006	NR	04		276	1604004	NR	01		262
1535011	NR	01		267	1541007	NR	04		276	1604005	NR	01		262
1535012	NR	01		267	1544001	NR	01		266	1605000	NR	01		262
1535013	NR	01		267	1544002	NR	01		266	1605001	NR	01		262
1535014	NR	01		267	1544003	NR	01		266	1605002	NR	01		262
1535015	NR	01		267	1544004	NR	01		266	1605003	NR	01		262
1535016	NR	01		267	1544005	NR	01		266	1605004	NR	01		262
1535017	NR	01		267	1544006	NR	01		266	1606000	NR	01		263
1535018	NR	01		267	1544007	NR	01		266	1606001	NR	01		263
1535019	NR	01		267	1544008	NR	01		266	1606002	NR	01		263
1535020	NR	01		267	1545001	NR	01		268	1606003	NR	01		263
1535021	NR	01		267	1545002	NR	01		268	1606004	NR	01		263
1535022	NR	01		267	1545003	NR	01		268	1606005	NR	01		263

INDICE PER CODICE ARTICOLO

codice	UM	cat.	euro	pag.	codice	UM	cat.	euro	pag.	codice	UM	cat.	euro	pag.
1606006	NR	01		263	1611001	NR	01		263	20022217526KR	MT	02		303
1606007	NR	01		263	1611002	NR	01		263	20028217526KR	MT	02		303
1607000	NR	01		263	1611003	NR	01		263	2005013	NR	24		195
1607001	NR	01		263	1611004	NR	01		263	2005015	NR	23		194
1607002	NR	01		263	1612000	NR	01		263	2005016	NR	23		194
1607003	NR	01		263	1612001	NR	01		263	2005030	NR	21		197
1607006	NR	01		263	1612002	NR	01		263	2005031	NR	21		197
1607007	NR	01		263	1612003	NR	01		263	2005040	NR	21		197
1607008	NR	01		263	1612004	NR	01		263	2005041	NR	21		197
1607009	NR	01		263	1614001	NR	01		262	2005050	NR	21		197
1607010	NR	01		263	1614002	NR	01		262	2005051	NR	21		197
1607011	NR	01		263	1614103	NR	01		262	2005084	NR	21		197
1607012	NR	01		263	19015215526	MT	21		303	2005090	NR	08		198
1608001	NR	01		263	19018215526	MT	21		303	2006002	NR	06		198
1608002	NR	01		263	19022215526	MT	21		303	2006004	KG	06		198
1608008	NR	01		263	19028215526	MT	21		303	2006010	NR	02		201-215
1609000	NR	01		263	19035215526	MT	21		303	2006011	NR	02		201-215
1609001	NR	01		263	19042215526	MT	21		303	2006012	NR	06		201
1609002	NR	01		263	1911001	NR	02		275	2006013	NR	06		201
1609003	NR	01		263	1911002	NR	02		275	2006014	NR	04		243
1609004	NR	01		263	1911003	NR	02		275	2006015	NR	04		243
1609005	NR	01		263	1911004	NR	02		275	2006018	NR	22		243
1609006	NR	01		263	1911005	NR	02		275	2006019	NR	04		243
1609007	NR	01		263	1911006	NR	02		275	2006020	NR	06		196
1609009	NR	01		263	1911007	NR	02		275	2006024	NR	05		202
1609010	NR	01		263	1911008	NR	02		275	2006025	NR	06		198
1609012	NR	01		263	1911009	NR	02		275	2006029	NR	02		198
1609015	NR	01		263	1912003	NR	09		275	2006030	NR	02		200
1609016	NR	01		263	1912004	NR	09		275	2006031	NR	02		200
1609017	NR	01		263	1912005	NR	09		275	2006032	NR	02		202
1609018	NR	01		263	1912006	NR	09		275	2006033	NR	02		202
1609019	NR	01		263	1912007	NR	09		275	2006034	NR	02		201
1609021	NR	01		263	1912008	NR	09		275	2006035	NR	02		202
1609022	NR	01		263	1913002	NR	21		275	2006098	NR	03		46-63
1609024	NR	01		263	1913003	NR	21		275	2006099	NR	11		46
1609025	NR	01		263	1913004	NR	21		275	2006300	NR	22		199
1609026	NR	01		263	1914002	NR	21		275	2006301	NR	22		199
1609027	NR	01		263	1914003	NR	21		275	2006304	NR	22		199
1609028	NR	01		263	1914004	NR	21		275	2006305	NR	22		199
1609029	NR	01		263	1914005	NR	21		275	2006307	NR	22		199
1609030	NR	01		263	1914006	NR	21		275	2006308	NR	22		199
1611000	NR	01		263	20018217526KR	MT	02		303	2006311	NR	19		200

INDICE PER CODICE ARTICOLO

codice	UM	cat.	euro	pag.	codice	UM	cat.	euro	pag.	codice	UM	cat.	euro	pag.
2006312	NR	19		200	2007023	NR	09		244	2009201	NR	11		246
2006313	NR	19		200	2007051	NR	06		245	2009202	NR	11		246
2006322	NR	22		199	2008050	NR	01		221	2009203	NR	11		246
2006323	NR	22		199	2008051	NR	01		221	2009204	NR	11		246
2006330	NR	22		199	2008052	NR	01		221	2012001	NR	22		207
2006340	NR	19		199-215-306	2008056	NR	01		221	2012002	NR	22		207
2006341	NR	19		199-215-306	2008057	NR	01		221	2012003	NR	22		207
2006346	NR	19		200	2008060	NR	01		221	2012004	NR	22		207
2006350	NR	19		198-306	2008061	NR	01		221	2012005	NR	22		207
2006361	NR	04		197	2008062	NR	01		221	2012006	NR	22		207
2006363	NR	04		197	2008063	NR	01		221	2012007	NR	22		207
2006372	NR	02		197	2008064	NR	01		221	2012101	NR	22		208
2006373	NR	02		197	2008065	NR	01		221	2012102	NR	22		208
2006374	NR	02		197	2009000	NR	05		196	2012201	NR	22		207
2006380	NR	05		198	2009003	NR	05		196	2012202	NR	22		207
2006381	NR	05		198	2009004	NR	05		196	2012401	NR	22		208
2006382	NR	05		201	2009005	NR	05		196	2012501	NR	20		209
2006383	NR	21		201	2009008	NR	05		196	2012601	NR	20		209
2006384	NR	21		201	2009009	NR	05		196-246	2012602	NR	20		209
2006385	NR	21		198	2009010	NR	22		205	2012603	NR	20		209
2006390	NR	06		202	2009011	NR	22		205	2012604	NR	20		209
2006391	NR	06		202	2009017	NR	05		196	2012701	NR	20		209
2006410	NR	19		200	2009020	NR	15		206	2012711	NR	20		209
2006413	NR	09		200	2009021	NR	15		206	2012722	NR	20		209
2006415	NR	19		200	2009041	NR	15		206	2012723	NR	20		209
2006601	NR	23		194	2009055	NR	15		205	2012821	NR	22		209
2006602	NR	23		194	2009060	NR	15		205	2012822	NR	22		209
2006603	NR	23		194	2009071	NR	15		206	2012823	NR	22		209
2006604	NR	23		194	2009081	NR	15		206	2012824	NR	22		209
2006605	NR	23		194	2009092	NR	15		206	2012825	NR	22		209
2006606	NR	23		194	2009100	NR	09		205	2012833	NR	22		208
2006607	NR	14		193	2009101	NR	09		205	2012834	NR	22		208
2006608	NR	14		193	2009102	NR	09		205	2012847	NR	22		208
2006621	NR	23		194	2009103	NR	09		205	2012890	NR	22		207
2007010	NR	03		244	2009120	NR	04		205	2012891	NR	22		207
2007011	NR	03		244	2009121	NR	04		205	2101001	NR	05		155
2007012	NR	09		244	2009122	NR	04		205	2101002	NR	05		155
2007013	NR	09		244	2009165	NR	04		205	2101011	NR	05		155
2007019	NR	03		244	2009166	NR	04		205	2101012	NR	05		155
2007020	NR	03		244	2009170	NR	09		205	2102001	NR	05		155
2007021	NR	03		244	2009171	NR	09		205	2102002	NR	05		155
2007022	NR	05		244	2009172	NR	09		205	2102101	NR	05		155

INDICE PER CODICE ARTICOLO

codice	UM	cat.	euro	pag.	codice	UM	cat.	euro	pag.	codice	UM	cat.	euro	pag.
2102102	NR	05		155	2204106	NR	01		158	2401301	NR	02		179
2103001	NR	05		155	2205102	NR	01		159	2401304	NR	02		180
2103002	NR	05		155	2205104	NR	01		159	2401305	NR	02		180
2103003	NR	05		156	2302101	NR	01		164	2402401	NR	01		162
2105001	NR	01		158	2302102	NR	01		164	2403001	NR	01		161
2105101	NR	01		158	2302104	NR	01		164	2403101	NR	01		162
2106002	NR	01		69-166	2303007	NR	01		124-163	2403401	NR	01		162
2106003	NR	01		69-166	2303008	NR	01		163	2403402	NR	01		162
2106007	NR	01		166	2303009	NR	01		124-163	2501001	NR	20		171
2106008	NR	01		166	2303010	NR	01		124-163	2502001	NR	20		172
2106012	NR	01		165	2303711	NR	01		163	2502003	NR	20		171
2106013	NR	01		165	2303911	NR	01		163	2502101	NR	20		171
2106015	NR	01		166	2304309	NR	01		164	2601006	NR	05		156
2106020	NR	01		165	2304317	NR	01		166	2601009	NR	05		156
2106025	NR	01		166	2304801	NR	04		161	2601013	NR	05		154
2106029	NR	01		165	2304802	NR	04		161	2601016	NR	05		154
2106034	NR	01		166	2304950	NR	04		160	2601017	NR	05		154
2106035	NR	01		165	2304951	NR	04		160	2601018	NR	05		154
2106037	NR	01		165	2304952	NR	04		160	2601020	NR	05		157
2106101	NR	01		166	2304953	NR	04		160	2601021	NR	05		157
2106102	NR	01		166	2304954	NR	04		160	2601024	NR	05		157
2106537	NR	01		165	2304955	NR	04		160	2601025	NR	05		157
2106637	NR	01		165	2304960	NR	04		160	2601027	NR	05		157
2106737	NR	01		165	2304963	NR	04		160	2601028	NR	05		157
2106837	NR	01		165	2304964	NR	04		160	2601718	NR	05		154
2106929	NR	01		165	2304965	NR	04		160	2601818	NR	05		154
2106937	NR	01		165	2304970	NR	04		160	2601918	NR	05		154
2201001	NR	01		167	2304971	NR	04		160	2602007	NR	01		158
2201002	NR	01		167	2304972	NR	04		161	2602015	NR	01		168
2201101	NR	01		167	2304974	NR	04		161	2651001	NR	09		169
2201102	NR	01		167	23322003	NR	17		36	2651002	NR	09		169
2201103	NR	01		167	23537003	NR	17		36	2651003	NR	09		169
2201201	NR	01		168	23707003	NR	17		34	2651005	NR	09		170
2201202	NR	01		167	23720003	NR	17		34	2651016	NR	09		169
2202001	NR	01		168	23722003	NR	17		35	2651017	NR	09		169
2202002	NR	01		168	23725003	NR	17		34	2651018	NR	09		169
2202003	NR	01		168	2372930A	NR	17		35	2651019	NR	09		169
2203001	NR	01		159	23730003	NR	17		34	2651020	NR	09		169
2203101	NR	01		159	2401001	NR	01		214	2651021	NR	09		169
2204102	NR	01		159	2401004	NR	01		214	2651022	NR	09		169
2204103	NR	01		159	2401101	NR	01		213	2651023	NR	09		169
2204104	NR	01		158	2401201	NR	02		179	2651028	NR	09		169

INDICE PER CODICE ARTICOLO

codice	UM	cat.	euro	pag.	codice	UM	cat.	euro	pag.	codice	UM	cat.	euro	pag.
2651031	NR	09		169	2661049	NR	09		169	2730216	NR	06		174
2651033	NR	09		170	2661050	NR	09		169	2730217	NR	06		174
2651034	NR	24		194	2661051	NR	09		169	2730223	NR	06		175
2651035	NR	24		194	2661053	NR	09		170	2730225	NR	06		175
2651036	NR	20		171	2661054	NR	09		170	2730251	NR	06		178
2651037	NR	20		171	2661057	NR	20		172	2730252	NR	06		178
2651039	NR	09		170	2661058	NR	20		172	2730261	NR	06		175
2651042	NR	20		171	2661059	NR	20		173	2730281	NR	06		175
2651044	NR	23		171	2661061	NR	20		173	2730282	NR	06		175
2651045	NR	23		171	2661076	NR	20		172	2730283	NR	06		175
2651046	NR	14		193	2661084	NR	20		171	2731101	NR	06		176
2651047	NR	14		193	2661086	NR	20		180	2731102	NR	06		176
2651050	NR	24		195	2661087	NR	23		180	2731103	NR	06		176
2651051	NR	24		195	2661088	NR	23		180	2731104	NR	06		108
2651052	NR	24		195	2661089	NR	23		180	2731105	NR	06		176
2651053	NR	24		195	2661090	NR	23		180	2731106	NR	06		176
2651054	NR	24		195	2661091	NR	23		180	2731121	NR	06		108
2651057	NR	24		195	2661092	NR	20		180	2732001	NR	06		178
2651058	NR	24		195	2661093	NR	20		180	2732003	NR	06		178
2651059	NR	24		195	2661094	NR	20		172	2732004	NR	06		178
2651060	NR	24		195	2661095	NR	20		173	2732005	NR	06		178
2651061	NR	24		195	2661097	NR	20		166-173	2732006	NR	06		178
2651062	NR	24		195	2661099	NR	20		162-173	2732008	NR	06		178
2651070	NR	24		195	2661100	NR	20		171	2733000	NR	06		145-177
2651072	NR	24		195	2661103	NR	20		171	2733001	NR	06		145-177
2651080	NR	09		170	2661104	NR	20		173	2733002	NR	06		145-177
2651081	NR	09		170	2661106	NR	20		173	2733003	NR	06		145-177
2651082	NR	09		170	2670001	NR	06		66	2733004	NR	06		145-177
26594000	NR	11		93	2670002	NR	06		66	2733005	NR	06		145-177
2661001	NR	20		171	2670003	NR	06		66	2733010	NR	06		177-221
2661002	NR	20		171	2670011	NR	06		66	2735001	NR	06		260
2661006	NR	20		192	2670012	NR	06		66	2735002	NR	06		260
2661011	NR	20		172	2670020	NR	06		66	2735011	NR	06		260
2661013	NR	20		180	2670021	NR	06		66	2735012	NR	06		260
2661014	NR	20		180	2670022	NR	06		66	2735021	NR	06		260
2661017	NR	20		180-215	2670023	NR	06		66	2735022	NR	06		260
2661021	NR	23		240	2670031	NR	06		66	2735031	NR	06		191-261
2661027	NR	20		171	27226001	NR	11		94	2735041	NR	06		191-261
2661028	NR	20		171	27232001	NR	11		94	2735051	NR	06		260
2661029	NR	20		171	2730203	NR	06		174	2735052	NR	06		260
2661030	NR	20		171	2730213	NR	06		174	2735053	NR	06		260
2661033	NR	20		172	2730214	NR	06		174	2735054	NR	06		260

INDICE PER CODICE ARTICOLO

codice	UM	cat.	euro	pag.	codice	UM	cat.	euro	pag.	codice	UM	cat.	euro	pag.
2735055	NR	06		260	2750266	NR	06		191-261	2750841	NR	09		169
2735056	NR	06		260	2750301	NR	06		191-261	2750842	NR	09		169
2735057	NR	06		260	2750311	NR	06		191-261	2750843	NR	09		169
2735059	NR	06		260	2750313	NR	06		191-261	2750844	NR	09		169
2735060	NR	06		260	2750314	NR	06		191-261	2750871	NR	09		169
2735061	NR	06		260	2750315	NR	06		191-261	2750872	NR	09		169
2735062	NR	06		260	2750316	NR	06		191-261	2750881	NR	09		169
2735063	NR	06		260	2750321	NR	06		191-261	2750901	NR	20		193
2735069	NR	06		260	2750400	NR	09		68	2750902	NR	20		193
2735070	NR	06		260	2750401	NR	09		69	2750903	NR	20		192
2735071	NR	06		260	2750410	NR	09		69	2750904	NR	20		193
2735091	NR	06		260	2750411	NR	09		69	2750905	NR	24		193
2735092	NR	06		260	2750450	NR	09		68	2750906	NR	24		193
2735111	NR	06		260	2750451	NR	09		68	2750907	NR	24		193
2735112	NR	06		260	2750452	NR	09		68	2750908	NR	20		193
2735132	NR	06		260	2750501	NR	09		190	2751001	NR	09		67
2735133	NR	06		260	2750502	NR	09		190	2751002	NR	09		67
2735141	NR	06		261	2750510	NR	09		190	2751017	NR	09		67
2735142	NR	06		261	2750531	NR	09		190	2751020	NR	09		67
2735143	NR	06		261	2750532	NR	09		190	2751021	NR	09		67
2735181	NR	06		261	2750533	NR	09		190	2751022	NR	09		67
2735182	NR	06		261	2750540	NR	09		190	2751030	NR	09		67
2735183	NR	06		261	2750541	NR	09		190	2751031	NR	09		67
2739216	NR	06		174	2750601	NR	20		192	2751032	NR	09		67
2750101	NR	09		190	2750602	NR	20		192	2751060	NR	09		68
2750102	NR	09		190	2750603	NR	20		192	2751061	NR	09		68
2750223	NR	06		260	2750620	NR	20		192	2751090	NR	09		69
2750224	NR	06		260	2750623	NR	20		192	2751121	NR	06		191-261
2750225	NR	06		260	2750624	NR	20		192	2751122	NR	06		191-261
2750226	NR	06		260	2750625	NR	20		192	2751123	NR	06		191-261
2750227	NR	06		260	2750630	NR	23		240	2751200	NR	09		67
2750240	NR	06		191-261	2750635	NR	23		240	2751201	NR	09		68
2750241	NR	06		191-261	2750640	NR	20		192	2751202	NR	09		68
2750242	NR	06		191-261	2750660	NR	20		173	2751204	NR	09		68
2750244	NR	06		191-261	2750831	NR	09		169	2751302	NR	09		69
2750245	NR	06		191-261	2750832	NR	09		169	2751303	NR	09		69
2750246	NR	06		191-261	2750833	NR	09		169	2751304	NR	09		69
2750247	NR	06		191-261	2750834	NR	09		169	2751305	NR	09		69
2750251	NR	06		191-261	2750835	NR	09		169	2751307	NR	09		69
2750252	NR	06		191-261	2750836	NR	09		169	2751308	NR	09		69
2750263	NR	06		191-261	2750838	NR	09		169	27597001	NR	11		103
2750264	NR	06		191-261	2750839	NR	09		169	27598001	NR	11		92

INDICE PER CODICE ARTICOLO

codice	UM	cat.	euro	pag.	codice	UM	cat.	euro	pag.	codice	UM	cat.	euro	pag.
27600001	NR	11		93	2811104	NR	06		182	2820105	NR	06		183
27794001	NR	11		92	2811105	NR	06		182	28261002	NR	11		103
2801102	NR	06		181	2811106	NR	06		182	28593002	NR	11		93
2801103	NR	06		181	2811201	NR	06		182	2862101	NR	21		183
2801104	NR	06		181	2811202	NR	06		182	2862102	NR	21		183
2804201	NR	06		181	2811203	NR	06		182	2862103	NR	21		183
2804202	NR	06		181	2811204	NR	06		182	2862104	NR	21		183
2804203	NR	06		181	2811205	NR	06		182	2862106	NR	21		183
2804204	NR	06		181	2811301	NR	06		182	2862107	NR	21		183
2804205	NR	06		181	2811302	NR	06		182	2862201	NR	21		183
2804503	NR	06		181	2811303	NR	06		182	2862202	NR	21		183
2810101	NR	06		182	2811304	NR	06		182	2862203	NR	21		183
2810102	NR	06		182	2811305	NR	06		182	2862204	NR	21		183
2810103	NR	06		182	2811306	NR	06		182	2862206	NR	21		183
2810104	NR	06		182	2811309	NR	06		182	2862207	NR	21		183
2810105	NR	06		182	2812101	NR	06		182	2862301	NR	21		183
2810106	NR	06		182	2812102	NR	06		182	2862302	NR	21		183
2810107	NR	06		182	2812103	NR	06		182	2862303	NR	21		183
2810109	NR	06		182	2812104	NR	06		182	2862304	NR	21		183
2810201	NR	06		182	2812105	NR	06		182	2862306	NR	21		183
2810202	NR	06		182	2812106	NR	06		182	2862307	NR	21		183
2810203	NR	06		182	2812302	NR	06		182	2862401	NR	21		183
2810204	NR	06		182	2812303	NR	06		182	2862402	NR	21		183
2810205	NR	06		182	2812305	NR	06		182	2862403	NR	21		183
2810206	NR	06		182	2812401	NR	06		182	2862404	NR	21		183
2810301	NR	06		182	2812402	NR	06		182	2862406	NR	21		183
2810302	NR	06		182	2812403	NR	06		182	2862407	NR	21		183
2810303	NR	06		182	2812404	NR	06		182	2862502	NR	21		183
2810304	NR	06		182	2812405	NR	06		182	2862503	NR	21		183
2810305	NR	06		182	2812406	NR	06		182	2862504	NR	21		183
2810401	NR	06		182	2812409	NR	06		182	2862602	NR	21		183
2810402	NR	06		182	2814202	NR	06		182	2862603	NR	21		183
2810403	NR	06		182	2814203	NR	06		182	2862701	NR	06		179-181
2810404	NR	06		182	2814204	NR	06		182	2862702	NR	06		179-181
2810405	NR	06		182	2814502	NR	06		183	2862703	NR	06		179-181
2810406	NR	06		182	2814503	NR	06		183	2862914	NR	06		179-183
2810407	NR	06		182	28151001	NR	11		112	2862915	NR	06		179-183
2810408	NR	06		182	2815201	NR	06		183	2870003	NR	06		181
2810409	NR	06		182	2815202	NR	06		183	2870004	NR	06		181
2811101	NR	06		182	2815203	NR	06		183	2870005	NR	06		181
2811102	NR	06		182	2820102	NR	06		183	2870006	NR	06		181
2811103	NR	06		182	2820103	NR	06		183	2870011	NR	06		181

INDICE PER CODICE ARTICOLO

codice	UM	cat.	euro	pag.	codice	UM	cat.	euro	pag.	codice	UM	cat.	euro	pag.
2870012	NR	06		181	3001019	NR	11		19	3004003	NR	11		33
2870013	NR	06		181	3001020	NR	11		19	3004004	NR	11		33
2872002	NR	06		181	3001710	NR	11		18	3004005	NR	11		33
2873004	NR	06		181	3001711	NR	11		18	3004006	NR	03		52
2873005	NR	06		181	3001712	NR	11		18	3004008	NR	03		53
2880001	NR	09		179	3001713	NR	11		18	3004009	NR	03		32-55
2880002	NR	09		179	3001714	NR	11		19	3004010	NR	03		52
2880003	NR	09		179	3001715	NR	11		19	3004012	NR	11		33
2880005	NR	09		179	3001716	NR	11		19	3005001	NR	05		41
2881001	NR	09		179	3001717	NR	11		20	3005002	NR	05		41
2881002	NR	09		179	3001718	NR	11		20	3005003	NR	05		42
2881003	NR	09		179	3001810	NR	11		18	3005004	NR	05		42
2881004	NR	09		179	3001811	NR	11		18	3005005	NR	05		43
2882001	NR	09		179	3001812	NR	11		18	3005008	NR	05		41
2882002	NR	09		179	3001813	NR	11		18	3005009	NR	05		41
2882003	NR	09		179	3001814	NR	11		19	3005010	NR	05		54
2882004	NR	09		179	3001815	NR	11		19	3005012	NR	05		50
2882005	NR	09		179	3001816	NR	11		19	3005014	NR	05		54
2883001	NR	20		179	3001817	NR	11		20	3005016	NR	05		42
2883101	NR	09		179	3001818	NR	11		20	3005020	NR	05		41
2883102	NR	09		179	3001910	NR	11		18	3005021	NR	05		42
2883103	NR	09		179	3001911	NR	11		18	3005025	NR	05		54
2900000	NR	13		247	3001912	NR	11		18	3005026	NR	05		43
2900001	NR	17		247	3001913	NR	11		18	3005027	NR	05		54
2900002	NR	17		247	3001914	NR	11		19	3005028	NR	03		54-221
2900003	NR	17		247	3001915	NR	11		19	3005029	NR	05		42
2900004	NR	17		247	3001916	NR	11		19	3005050	NR	03		48
29119000	NR	10		74	3001917	NR	11		20	3005051	NR	03		48
29121000	NR	10		74	3001918	NR	11		20	3005101	NR	11		20-24-44
29124000	NR	10		74	3002013	NR	03		55	3005102	NR	11		20-23-44
29126000	NR	10		74	3002014	NR	03		55	3005751	NR	03		48
3001000	NR	11		46-48	3003010	NR	03		30	3005950	NR	03		48
3001005	NR	03		75	3003011	NR	03		30	3006001	NR	11		32
3001010	NR	11		18	3003012	NR	03		30	3007001	NR	05		38
3001011	NR	11		18	3003013	NR	03		31	3007002	NR	05		38
3001012	NR	11		18	3003014	NR	03		31	3007003	NR	05		38
3001013	NR	11		18	3003015	NR	03		31	3007004	NR	05		39
3001014	NR	11		19	3003016	NR	03		31	3007005	NR	05		39
3001015	NR	11		19	3003019	NR	03		30-55	3007006	NR	05		39
3001016	NR	11		19	3003020	NR	03		30	3007007	NR	05		39
3001017	NR	11		20	3004001	NR	11		32	3007008	NR	05		40
3001018	NR	11		20	3004002	NR	11		32	3007009	NR	05		40

INDICE PER CODICE ARTICOLO

codice	UM	cat.	euro	pag.	codice	UM	cat.	euro	pag.	codice	UM	cat.	euro	pag.
3007018	NR	05		50	3008922	NR	02		63	3021819	NR	11		24
3007019	NR	05		53	3009015	NR	03		48	3021820	NR	11		24
3007023	NR	05		40	3012001	NR	11		72	3021823	NR	03		51
3007024	NR	05		38	3012002	NR	11		72	3021824	NR	03		51
3008001	NR	11		25	3012003	NR	11		72	3021825	NR	03		49
3008002	NR	11		26	3012901	NR	11		72	3021826	NR	11		21
3008003	NR	11		26	3012902	NR	11		72	3021827	NR	11		22
3008004	NR	11		27	3012903	NR	11		72	3021831	NR	11		24
3008005	NR	11		27	3013001	NR	11		73	3021910	NR	11		21
3008006	NR	11		26	3013002	NR	11		73	3021911	NR	11		21
3008007	NR	11		27	3013003	NR	11		73	3021912	NR	11		22
3008009	NR	11		25	3013901	NR	11		73	3021913	NR	11		21
3008010	NR	11		25	3013902	NR	11		73	3021914	NR	11		22
3008011	NR	11		25	3013903	NR	11		73	3021915	NR	11		23
3008012	NR	11		26	3021010	NR	11		21	3021916	NR	11		22
3008032	NR	03		50	3021011	NR	11		21	3021917	NR	11		23
3008033	NR	03		51	3021012	NR	11		22	3021918	NR	11		23
3008034	NR	03		49	3021013	NR	11		21	3021919	NR	11		24
3008801	NR	03		28	3021014	NR	11		22	3021920	NR	11		24
3008802	NR	03		28-55	3021015	NR	11		23	3021923	NR	03		51
3008803	NR	03		28	3021016	NR	11		22	3021924	NR	03		51
3008804	NR	03		29	3021017	NR	11		23	3021925	NR	03		49
3008805	NR	03		28	3021018	NR	11		23	3021926	NR	11		21
3008806	NR	03		29	3021019	NR	11		24	3021927	NR	11		22
3008807	NR	03		29	3021020	NR	11		24	3021931	NR	11		24
3008808	NR	03		52	3021021	NR	11		24	30499000	NR	13		47
3008809	NR	03		53	3021022	NR	11		23	3101001	NR	02		62
3008810	NR	03		49	3021023	NR	03		51	3101004	NR	02		62
3008850	NR	03		52	3021024	NR	03		51	3101005	NR	09		57
3008901	NR	02		62	3021025	NR	03		49	3101006	NR	09		57
3008903	NR	02		62	3021026	NR	11		21	3101012	NR	20		172
3008904	NR	02		57	3021027	NR	11		22	3101014	NR	02		65
3008905	NR	02		57	3021031	NR	11		24	3101015	NR	02		65
3008906	NR	02		57	3021810	NR	11		21	3101018	NR	02		65
3008908	NR	02		57	3021811	NR	11		21	3101020	NR	02		64
3008910	NR	02		64	3021812	NR	11		22	3101031	NR	09		59
3008911	NR	02		64	3021813	NR	11		21	3101032	NR	09		59
3008913	NR	02		62	3021814	NR	11		22	3101038	NR	02		65
3008915	NR	02		57	3021815	NR	11		23	3101042	NR	09		56
3008918	NR	02		64	3021816	NR	11		22	3101054	NR	02		63
3008919	NR	02		64	3021817	NR	11		23	3101057	NR	02		63
3008920	NR	02		58	3021818	NR	11		23	3101059	NR	09		58

INDICE PER CODICE ARTICOLO

codice	UM	cat.	euro	pag.	codice	UM	cat.	euro	pag.	codice	UM	cat.	euro	pag.
3101060	NR	09		58	3101138	NR	02		65	3302117	NR	06		146
3101061	NR	06		61	31367001	NR	11		50	3302119	NR	06		146
3101064	NR	02		63	3202001	NR	04		139	3302126	NR	06		146
3101065	NR	02		64	3202002	NR	04		139	3302127	NR	06		146
3101066	NR	02		65	3203007	NR	04		139	3302128	NR	06		146
3101069	NR	09		56	3203033	NR	05		138	3302129	NR	02		146
3101070	NR	02		62	3203034	NR	05		138	3302201	NR	06		146
3101072	NR	09		59	3203051	NR	06		139	3302202	NR	06		146
3101074	NR	09		56	3203054	NR	05		137	3302203	NR	06		145
3101075	NR	02		63	3203056	NR	13		132	3302204	NR	06		145
3101076	NR	09		59	3203057	NR	05		126	3302205	NR	06		145
3101077	NR	06		61	3203058	NR	05		126	3302301	NR	06		142
3101081	NR	02		64	3203059	NR	13		132	3302302	NR	06		142
3101084	NR	02		66	3203060	NR	02		132	3302410	NR	06		143
3101088	NR	06		61	3203061	NR	02		132	3302411	NR	06		143
3101089	NR	06		61	3203063	NR	02		132	33202003	NR	17		50
3101090	NR	02		66	3203067	NR	03		139	33265003	NR	17		36
3101096	NR	02		65	3203092	NR	05		139	33281003	NR	17		53
3101097	NR	09		56	32224003	NR	17		53	33302003	NR	17		37
3101098	NR	09		56	32929003	NR	17		36	33305003	NR	17		37
3101099	NR	09		56	3301001	NR	01		140	3350001	NR	13		186
3101100	NR	09		56	3301012	NR	01		140	3350010	NR	13		243
3101101	NR	09		56	3301032	NR	02		140	3350011	NR	13		243
3101102	NR	06		62	3301041	NR	02		141	3350020	NR	13		213
3101103	NR	06		62	3301051	NR	01		140	3350021	NR	13		242
3101104	NR	06		62	3301080	NR	02		141	3350024	NR	13		242
3101106	NR	06		62	3302006	NR	15		143	3350028	NR	13		242
3101107	NR	06		61	3302007	NR	15		143	3350040	NR	13		187
3101108	NR	06		61	3302010	NR	01		143	3350050	NR	13		186
3101109	NR	02		66	3302013	NR	06		145	3350060	NR	13		185
3101110	NR	02		66	3302016	NR	01		143	3350070	NR	17		187
3101111	NR	02		65	3302017	NR	15		143	3350080	NR	13		185
3101112	NR	02		58	3302101	NR	06		144	3350090	NR	13		185
3101113	NR	02		58	3302103	NR	06		144	3350100	NR	13		185
3101114	NR	02		63	3302104	NR	06		144	3350110	NR	13		187
3101115	NR	02		63	3302106	NR	06		144	3350503	NR	10		186
3101116	NR	02		63	3302107	NR	06		144	3350610	NR	10		243
3101117	NR	06		61	3302108	NR	06		144	3350640	NR	13		187
3101120	NR	09		68	3302109	NR	06		144	3351021	NR	03		242
3101122	NR	09		61	3302112	NR	06		144	3351023	NR	03		213
3101123	NR	02		64	3302114	NR	23		194	3351024	NR	03		242
3101124	NR	02		64	3302115	NR	23		194	33555003	NR	17		37

INDICE PER CODICE ARTICOLO

codice	UM	cat.	euro	pag.	codice	UM	cat.	euro	pag.	codice	UM	cat.	euro	pag.
33556003	NR	17		37	3408012	NR	03		151	3602070	NR	03		119
3402001	NR	03		148	3408013	NR	03		151	36327001	NR	13		43
3402002	NR	03		148	34558000	NR	17		75	36451000	NR	10		43
3402003	NR	03		148	34827000	NR	17		75	3701601	NR	03		120
3402004	NR	03		148	3501011	NR	05		123	3701602	NR	03		120
3402005	NR	03		148	3501013	NR	05		123	3701603	NR	03		120
3402006	NR	03		148	3501016	NR	05		123	3701702	NR	03		120
3402007	NR	03		148	3502013	NR	05		123	3701703	NR	03		120
3402008	NR	03		148	3502015	NR	05		123	3701704	NR	03		120
3402009	NR	03		148	3502016	NR	05		123	3702305	NR	04		116
3402010	NR	03		148	3502017	NR	05		123	3702321	NR	04		117
3402011	NR	03		148	3502018	NR	05		123	3702325	NR	09		118
3402012	NR	03		148	3502020	NR	05		123	3702329	NR	04		116
3402013	NR	03		148	3503011	NR	05		124	3702330	NR	04		116
3403001	NR	03		149	3503016	NR	05		124	3702332	NR	04		116
3403002	NR	03		149	3517001	NR	04		122	3702333	NR	09		118
3403003	NR	03		149	3517002	NR	04		122	3702334	NR	04		117
3403004	NR	03		149	3517003	NR	04		122	3702335	NR	09		120
3403005	NR	03		149	3517004	NR	04		122	3702336	NR	04		117
3403006	NR	03		149	3517005	NR	04		122	3702337	NR	04		117
3403007	NR	03		149	3517006	NR	04		122	3702338	NR	04		117
3403008	NR	03		149	3517007	NR	04		122	3702339	NR	04		117
3403009	NR	03		149	3517008	NR	04		122	3702341	NR	04		116
3405001	NR	03		150	3517009	NR	04		122	3702342	NR	04		116
3405002	NR	03		150	3517010	NR	04		122	3702343	NR	04		116
3405003	NR	03		150	3517011	NR	04		122	3702344	NR	04		116
3405004	NR	03		150	3518050	NR	04		121	3702345	NR	09		118
3405021	NR	03		150	3518051	NR	04		121	3702346	NR	09		118
3405022	NR	03		150	3519001	NR	03		121	3702347	NR	09		118
3405030	NR	03		149	3519002	NR	03		121	3702348	NR	09		118
3407005	NR	03		150	3519003	NR	03		121	37054SH0	NR	10		142
3407006	NR	03		150	3519004	NR	03		121	37092000	NR	10		146
3407007	NR	03		150	3519005	NR	03		121	37103SH0	NR	10		145
3407008	NR	03		150	3519006	NR	03		121	37859SH0	NR	10		142
3407061	NR	03		149	3519007	NR	03		121	38372SH0	NR	17		141
3407062	NR	03		149	3519008	NR	03		121	38729000	NR	17		142
3407063	NR	03		149	3519009	NR	03		121	38732000	NR	11		142
3407064	NR	03		149	3550003	NR	13		186	38732SH0	NR	11		142
3408001	NR	03		151	35604000	NR	13		44-74	38863000	NR	17		141
3408002	NR	03		151	3602040	NR	04		119	4001052	NR	26		125
3408003	NR	03		151	3602060	NR	04		119	4001053	NR	26		125
3408011	NR	03		151	3602062	NR	04		119	4001054	NR	26		125

INDICE PER CODICE ARTICOLO

codice	UM	cat.	euro	pag.	codice	UM	cat.	euro	pag.	codice	UM	cat.	euro	pag.
4001059	NR	17		127	4101007	NR	03		130	4600019	NR	02		298
4001061	NR	26		125	4102001	NR	03		130	4600021	NR	02		298
4001062	NR	26		125	4104001	NR	10		130	4600023	NR	02		298
4001063	NR	26		125	4104002	NR	10		130	4600025	NR	02		298
4001064	NR	17		126	4104004	NR	03		130	4600027	NR	02		298
4001065	NR	17		127	4104005	NR	03		130	4600029	NR	02		298
4001066	NR	10		128	42253000	NR	10		147	4600033	NR	02		298
4001067	NR	10		128	42310000	NR	10		147	4600035	NR	02		298
4001069	NR	26		126	42961000	NR	10		147	4600037	NR	02		298
4001070	NR	26		126	42962000	NR	10		147	4600039	NR	02		298
4001071	NR	17		127	4301001	NR	11		131	4600042	NR	02		298
4002003	NR	10		128	4301002	NR	11		131	4600044	NR	02		298
4002004	NR	13		127	4301003	NR	11		131	4601003	NR	01		298
4002005	NR	13		127	4301004	NR	11		131	4601005	NR	01		298
4003002	NR	10		128	4301005	NR	11		131	4601009	NR	01		298
4009007	NR	03		133	4301006	NR	11		131	4601011	NR	01		298
4009008	NR	03		133	4301007	NR	11		131	4601013	NR	01		298
4009011	NR	17		128	4301008	NR	11		131	4601014	NR	01		298
4009013	NR	02		134	43486000	NR	10		147	4601015	NR	01		298
4009014	NR	02		135	43544000	NR	10		147	4601016	NR	01		298
4009015	NR	02		135	43546000	NR	10		147	4601017	NR	01		298
4009016	NR	02		135	43733000	NR	10		147	4601019	NR	01		298
4009017	NR	03		134	43917000	NR	10		147	4601020	NR	01		298
4009018	NR	03		134	43966000	NR	10		147	4601021	NR	01		298
4009019	NR	03		134	43985000	NR	10		147	4601022	NR	01		298
4009023	NR	03		133	43991000	NR	10		146	4601023	NR	01		298
4009024	NR	03		133	43992000	NR	10		147	4601025	NR	01		298
4009026	NR	03		134	4501001	NR	03		294	4601027	NR	01		298
4009027	NR	03		133	4501002	NR	03		294	4601029	NR	01		298
4009901	NR	12		136	4501003	NR	03		294	4601031	NR	01		298
4009906	NR	12		136	4501004	NR	03		294	4601035	NR	01		298
4009907	NR	12		136	4501005	NR	03		294	4601037	NR	01		298
4009913	NR	12		136	4501006	NR	03		294	4601039	NR	01		298
40404001	NR	13		45-47-63	4501007	NR	03		294	4601041	NR	01		298
40430001	NR	13		45-47-63	4501008	NR	03		294	4601043	NR	01		298
4101000	NR	03		130	4501009	NR	03		294	4601045	NR	01		298
4101001	NR	03		130	45346000	NR	10		59	4601049	NR	01		298
4101002	NR	03		130	45869000	NR	10		59	4601051	NR	01		298
4101003	NR	03		130	4600011	NR	02		298	4601054	NR	01		298
4101004	NR	03		130	4600013	NR	02		298	4601055	NR	01		298
4101005	NR	03		130	4600015	NR	02		298	4602001	NR	01		298
4101006	NR	03		130	4600017	NR	02		298	4602003	NR	01		298

INDICE PER CODICE ARTICOLO

codice	UM	cat.	euro	pag.	codice	UM	cat.	euro	pag.	codice	UM	cat.	euro	pag.
4602005	NR	01		298	4654008	MT	22		301	4701137	NR	01		297
4602007	NR	01		298	4654009	MT	22		301	4701138	NR	01		297
4602009	NR	01		298	4654010	MT	22		301	4701139	NR	01		297
4602011	NR	01		298	4654011	MT	22		301	4701140	NR	01		297
4602013	NR	01		298	4654012	MT	22		301	4701211	NR	21		297
4602015	NR	01		298	4654014	MT	22		301	4701212	NR	21		297
4602017	NR	01		298	4654015	MT	22		301	4701215	NR	21		297
4602019	NR	01		298	4654018	MT	22		301	4701216	NR	21		297
4602021	NR	01		298	4654020	MT	22		301	4701219	NR	21		297
4602023	NR	01		298	4654021	MT	22		301	4701220	NR	21		297
4602025	NR	01		298	4654022	MT	22		301	4701221	NR	21		297
4602031	NR	01		298	4655003	MT	22		301	4701222	NR	21		297
4602044	NR	01		298	4655004	MT	22		301	4702001	NR	01		297
4602045	NR	01		298	4655005	MT	22		301	4702003	NR	01		297
46048000	NR	10		58	4655006	MT	22		301	4702005	NR	01		297
4606010	NR	01		300	4655007	MT	22		301	4702007	NR	01		297
4606011	NR	01		300	4655009	MT	22		301	4702009	NR	01		297
4606015	NR	01		300	4655010	MT	22		301	4702011	NR	01		297
4606100	NR	01		300	4655011	MT	22		301	4702013	NR	01		297
4606101	NR	01		300	4655012	MT	22		301	4702015	NR	01		297
4606104	NR	01		300	4655014	MT	22		301	4702017	NR	01		297
4606105	NR	01		300	4655015	MT	22		301	4702019	NR	01		297
4606301	NR	01		300	46580000	NR	10		58	4702023	NR	01		297
4606302	NR	01		300	4662002	NR	02		301	4702027	NR	01		297
4606303	NR	01		300	4662003	NR	02		301	4702031	NR	01		297
4606304	NR	01		300	4662004	NR	02		301	4702032	NR	01		297
4606310	NR	01		300	4662005	NR	02		301	4702034	NR	01		297
4606311	NR	01		300	4662006	NR	02		301	4703001	NR	01		297
4606313	NR	01		300	4663001	NR	02		301	4703002	NR	01		297
4606401	NR	01		300	4663003	NR	02		301	4703003	NR	01		297
4606409	NR	01		300	4663005	NR	02		301	4703004	NR	01		297
4606410	NR	01		300	4663006	NR	02		301	4703006	NR	01		297
4606411	NR	01		300	4701101	NR	07		297	4703007	NR	01		297
4606412	NR	01		300	4701102	NR	07		297	4703008	NR	01		297
46092000	NR	10		65	4701103	NR	07		297	4711001	NR	03		299
46374000	NR	10		58	4701104	NR	07		297	4711002	NR	03		299
4654002	MT	22		301	4701105	NR	07		297	4711012	NR	03		299
4654003	MT	22		301	4701106	NR	07		297	4711112	NR	03		299
4654004	MT	22		301	4701109	NR	07		297	4730002	NR	02		298
4654005	MT	22		301	4701110	NR	07		297	4730003	NR	02		298
4654006	MT	22		301	4701111	NR	07		297	4730004	NR	02		298
4654007	MT	22		301	4701112	NR	07		297	4730005	NR	02		298

INDICE PER CODICE ARTICOLO

codice	UM	cat.	euro	pag.	codice	UM	cat.	euro	pag.	codice	UM	cat.	euro	pag.
4730006	NR	02		298	4820002	NR	02		295	4821112	NR	02		295
4740001	NR	02		299	4820003	NR	02		295	4821201	NR	02		295
4740002	NR	02		299	4820004	NR	02		295	4821202	NR	02		295
4740003	NR	02		299	4820005	NR	02		295	4821203	NR	02		295
4740009	NR	02		299	4820006	NR	02		295	4821204	NR	02		295
4740016	NR	02		299	4820007	NR	02		295	4821205	NR	02		295
4744001	NR	09		299	4820008	NR	02		295	4821206	NR	02		295
4744002	NR	09		299	4820009	NR	02		295	4821207	NR	02		295
4744003	NR	09		299	4820010	NR	02		295	4821208	NR	02		295
4744004	NR	09		299	4820011	NR	02		295	4821211	NR	02		295
4744005	NR	09		299	4820012	NR	02		295	4825104	NR	02		296
4744006	NR	09		299	4820103	NR	02		295	4825105	NR	02		296
47450000	NR	10		61	4820104	NR	02		295	4825106	NR	02		296
4801001	NR	02		294	4820105	NR	02		295	4825107	NR	02		296
4801002	NR	02		294	4820106	NR	02		295	4825108	NR	02		296
4801003	NR	02		294	4820107	NR	02		295	4825109	NR	02		296
4801004	NR	02		294	4820108	NR	02		295	4826009	NR	02		296
4801005	NR	02		294	4820109	NR	02		295	4826016	NR	02		296
4802001	NR	02		294	4820110	NR	02		295	4826020	NR	02		296
4802002	NR	02		294	4820111	NR	02		295	4826021	NR	02		296
4802003	NR	02		294	4820113	NR	02		295	4826023	NR	02		296
4802004	NR	02		294	4820120	NR	02		295	4826026	NR	02		296
4802005	NR	02		294	4820122	NR	02		295	4826504	NR	02		296
4802006	NR	02		294	4821002	NR	02		296	4826505	NR	02		296
4802007	NR	02		294	4821003	NR	02		296	4826506	NR	02		296
4802008	NR	02		294	4821004	NR	02		296	4826507	NR	02		296
4805001	NR	02		294	4821005	NR	02		296	4826508	NR	02		296
48066000	NR	10		65	4821006	NR	02		296	4826509	NR	02		296
4808001	NR	02		294	4821007	NR	02		296	4830001	NR	02		291
4808002	NR	02		294	4821008	NR	02		296	4830002	NR	02		291
4808003	NR	02		294	4821009	NR	02		296	4830003	NR	02		291
4808004	NR	02		294	4821010	NR	02		296	4830004	NR	02		291
4808005	NR	02		294	4821013	NR	02		296	4830005	NR	02		291
4808006	NR	02		294	4821101	NR	02		295	4830006	NR	02		291
4808007	NR	02		294	4821102	NR	02		295	4830007	NR	02		291
4809001	NR	02		294	4821103	NR	02		295	4830008	NR	02		291
4809003	NR	02		294	4821104	NR	02		295	4830009	NR	02		291
4809005	NR	02		294	4821105	NR	02		295	4830010	NR	02		291
4809007	NR	02		294	4821106	NR	02		295	4831002	NR	02		291
4809009	NR	02		294	4821107	NR	02		295	4831003	NR	02		291
4809010	NR	02		294	4821108	NR	02		295	4831005	NR	02		291
4809011	NR	02		294	4821109	NR	02		295	4831007	NR	02		291

INDICE PER CODICE ARTICOLO

codice	UM	cat.	euro	pag.	codice	UM	cat.	euro	pag.	codice	UM	cat.	euro	pag.
4831008	NR	02		291	4835007	NR	02		291	4841008	NR	02		292
4832002	NR	02		291	4835008	NR	02		291	4841009	NR	02		292
4832004	NR	02		291	4835009	NR	02		291	4845001	NR	02		292
4832005	NR	02		291	4835010	NR	02		291	4845003	NR	02		292
4832008	NR	02		291	4836003	NR	02		292	4853001	NR	03		252
4832009	NR	02		291	4836006	NR	02		292	4853002	NR	03		252
4832010	NR	02		291	4836009	NR	02		292	4853003	NR	03		252
4832011	NR	02		291	4836010	NR	02		292	4853101	NR	03		252
4832013	NR	02		291	4836013	NR	02		292	4853102	NR	03		252
4832014	NR	02		291	4836016	NR	02		292	4853103	NR	03		252
4832015	NR	02		291	4836020	NR	02		292	4853201	NR	03		252
4832019	NR	02		291	4836023	NR	02		292	4853202	NR	03		252
4832020	NR	02		291	4836026	NR	02		292	4853203	NR	03		252
4832023	NR	02		291	4837003	NR	02		292	4853204	NR	03		252
4832026	NR	02		291	4837004	NR	02		292	4853206	NR	03		252
4832030	NR	02		291	4837005	NR	02		292	4853208	NR	03		252
4832034	NR	02		291	4837006	NR	02		292	4853301	NR	03		252
4833003	NR	02		291	4837010	NR	02		292	4853302	NR	03		252
4833004	NR	02		291	4837013	NR	02		292	4853303	NR	03		252
4833007	NR	02		291	4837016	NR	02		292	4853304	NR	03		252
4833010	NR	02		291	4837019	NR	02		292	4853306	NR	03		252
4833011	NR	02		291	4837021	NR	02		292	4853307	NR	03		252
4833014	NR	02		291	4837023	NR	02		292	4853308	NR	03		252
4833017	NR	02		291	4838003	NR	02		292	4853401	NR	03		253
4833021	NR	02		291	4838004	NR	02		292	4853402	NR	03		253
4833024	NR	02		291	4838005	NR	02		292	4853501	NR	03		253
4833028	NR	02		291	4838006	NR	02		292	4853502	NR	03		253
4833031	NR	02		291	4838009	NR	02		292	4853503	NR	03		253
4834001	NR	02		292	4838010	NR	02		292	4853601	NR	03		253
4834002	NR	02		292	4838013	NR	02		292	4853602	NR	03		253
4834003	NR	02		292	4838014	NR	02		292	4853605	NR	03		253
4834004	NR	02		292	4838017	NR	02		292	4853701	NR	03		253
4834005	NR	02		292	4838020	NR	02		292	4853702	NR	03		253
4834006	NR	02		292	4838023	NR	02		292	4853703	NR	03		253
4834007	NR	02		292	4838025	NR	02		292	4853704	NR	03		253
4834008	NR	02		292	4841001	NR	02		292	4853801	NR	03		253
4834009	NR	02		292	4841002	NR	02		292	4853802	NR	03		253
4835002	NR	02		291	4841003	NR	02		292	4853803	NR	03		253
4835003	NR	02		291	4841004	NR	02		292	4853805	NR	03		253
4835004	NR	02		291	4841005	NR	02		292	4853901	NR	03		253
4835005	NR	02		291	4841006	NR	02		292	4853902	NR	03		253
4835006	NR	02		291	4841007	NR	02		292	4854001	NR	03		253

INDICE PER CODICE ARTICOLO

codice	UM	cat.	euro	pag.	codice	UM	cat.	euro	pag.	codice	UM	cat.	euro	pag.
4854002	NR	03		253	4890003	MT	05		254	4894004	NR	05		255
4854003	NR	03		253	4890004	MT	05		254	4894005	NR	05		255
4854004	NR	03		253	4890006	MT	05		254	4894006	NR	05		255
4854010	NR	03		253	4890007	MT	05		254	4894007	NR	05		255
4854101	NR	03		253	4890008	MT	05		254	4894101	NR	05		255
4854102	NR	03		253	4890101	MT	05		254	4894102	NR	05		255
4854103	NR	03		253	4890102	MT	05		254	4894103	NR	05		255
4854201	NR	03		253	4890103	MT	05		254	4894104	NR	05		255
4854202	NR	03		253	4890104	MT	05		254	4894105	NR	05		255
4880001	NR	07		293	4890105	MT	05		254	4894106	NR	05		255
4880003	NR	07		293	4890106	MT	05		254	4894107	NR	05		255
4880004	NR	07		293	4890107	MT	05		254	4894108	NR	05		255
4880006	NR	07		293	4890201	MT	05		252	4894109	NR	05		255
4880007	NR	07		293	4890202	MT	05		252	4894110	NR	05		255
4880008	NR	07		293	4890203	MT	05		252	4894111	NR	05		255
4880009	NR	07		293	4890204	MT	05		252	4894202	NR	05		255
4880010	NR	07		293	4890401	MT	05		252	4894203	NR	05		255
4880013	NR	07		293	4890402	MT	05		252	4894204	NR	05		255
4880014	NR	07		293	4890403	MT	05		252	4894205	NR	05		255
4880023	NR	07		293	4891001	MT	05		254	4894206	NR	05		255
4882001	NR	07		293	4891002	MT	05		254	4894207	NR	05		255
4882002	NR	07		293	4891003	MT	05		254	4894208	NR	05		255
4882003	NR	07		293	4891005	MT	05		254	4894209	NR	05		255
4882004	NR	07		293	4891006	MT	05		254	4894210	NR	05		255
4882006	NR	07		293	4891007	MT	05		254	4894301	NR	05		255
4882007	NR	07		293	4891008	MT	05		254	4894302	NR	05		255
4882008	NR	07		293	4891009	MT	05		254	4894303	NR	05		255
4882009	NR	07		293	4892001	MT	05		254	4894304	NR	05		255
4882010	NR	07		293	4892002	MT	05		254	4894305	NR	05		255
4882011	NR	07		293	4892003	MT	05		254	4894306	NR	05		255
4882012	NR	07		293	4892005	MT	05		254	4894307	NR	05		255
4882014	NR	07		293	4892006	MT	05		254	4894308	NR	05		255
4882015	NR	07		293	4892007	MT	05		254	4894401	NR	05		256
4882016	NR	07		293	4892008	MT	05		254	4894402	NR	05		256
4882017	NR	07		293	4892009	MT	05		254	4894403	NR	05		256
4882022	NR	07		293	4893001	MT	05		254	4894404	NR	05		256
4882029	NR	07		293	4893003	MT	05		254	4894405	NR	05		256
4882035	NR	07		293	4893004	MT	05		254	4894406	NR	05		256
4884001	NR	07		293	4893005	MT	05		254	4894407	NR	05		256
4884003	NR	07		293	4894001	NR	05		255	4894501	NR	05		255
4890001	MT	05		254	4894002	NR	05		255	4894502	NR	05		255
4890002	MT	05		254	4894003	NR	05		255	4894503	NR	05		255

INDICE PER CODICE ARTICOLO

codice	UM	cat.	euro	pag.	codice	UM	cat.	euro	pag.	codice	UM	cat.	euro	pag.
4894504	NR	05		255	4895018	NR	05		256	5800060	NR	20		239
4894505	NR	05		255	4895019	NR	05		256	5800061	NR	20		238
4894506	NR	05		255	4895020	NR	05		256	5810001	NR	22		238
4894507	NR	05		255	4895021	NR	05		256	5810002	NR	22		238
4894601	NR	05		256	4895022	NR	05		256	5810003	NR	22		238
4894602	NR	05		256	4895023	NR	05		256	5810004	NR	22		238
4894603	NR	05		256	4895101	NR	05		257	5810005	NR	22		238
4894604	NR	05		256	4895103	NR	05		257	5810006	NR	22		238
4894605	NR	05		256	4895104	NR	05		257	5810007	NR	22		238
4894606	NR	05		256	4895105	NR	05		257	5810008	NR	22		238
4894607	NR	05		256	4895301	NR	05		257	5810017	NR	22		238
4894608	NR	05		256	4895302	NR	05		257	5810018	NR	22		238
4894701	NR	05		256	4895400	NR	05		257	5810019	NR	22		238
4894702	NR	05		256	4895401	NR	05		257	5810020	NR	22		238
4894703	NR	05		256	4895402	NR	05		257	5810021	NR	22		238
4894704	NR	05		256	4895404	NR	05		257	5810022	NR	22		238
4894705	NR	05		256	4895601	NR	05		257	5810100	NR	22		238
4894706	NR	05		256	4895701	NR	05		257	5810101	NR	22		238
4894707	NR	05		256	4895801	NR	05		257	5810102	NR	22		238
4894708	NR	05		256	4896401	NR	05		257	5810103	NR	22		238
4894801	NR	05		255	4897001	NR	05		256	5810104	NR	22		238
4894802	NR	05		255	4897002	NR	05		256	5810105	NR	22		238
4894803	NR	05		255	4897003	NR	05		256	5810108	NR	22		238
4894804	NR	05		255	4897101	NR	05		256	5810109	NR	22		238
4894805	NR	05		255	4897102	NR	05		256	5810110	NR	22		238
4894806	NR	05		255	4898501	NR	05		257	5810111	NR	22		238
4894807	NR	05		255	4898601	NR	05		257	5810112	NR	22		238
4895001	NR	05		256	5800001	NR	22		237	5810113	NR	22		238
4895002	NR	05		256	5800002	NR	22		237	5810114	NR	22		238
4895003	NR	05		256	5800011	NR	22		237	5810115	NR	22		238
4895004	NR	05		256	5800012	NR	22		237	5810116	NR	22		238
4895005	NR	05		256	5800021	NR	22		237	5810117	NR	22		238
4895006	NR	05		256	5800023	NR	22		237	5810301	NR	22		237
4895007	NR	05		256	5800031	NR	22		237	5810302	NR	22		237
4895008	NR	05		256	5800033	NR	20		239	5810305	NR	22		237
4895009	NR	05		256	5800034	NR	20		239	5810306	NR	22		237
4895012	NR	05		256	5800035	NR	22		237	5810401	NR	20		239
4895013	NR	05		256	5800037	NR	20		239	5810404	NR	20		239
4895014	NR	05		256	5800038	NR	20		239	5810501	NR	20		239
4895015	NR	05		256	5800040	NR	20		239	5810502	NR	20		239
4895016	NR	05		256	5800050	NR	20		239	5810503	NR	20		239
4895017	NR	05		256	5800051	NR	20		239	5810550	NR	20		239

INDICE PER CODICE ARTICOLO

codice	UM	cat.	euro	pag.	codice	UM	cat.	euro	pag.	codice	UM	cat.	euro	pag.
5810601	NR	22		238	5901014	NR	03		241	6010007	NR	20		239
5810602	NR	22		238	5901020	NR	03		241	6010009	NR	20		239
5810603	NR	22		238	5901022	NR	03		241	6010015	NR	20		238
5810604	NR	22		238	6000000	NR	10		230	6010018	NR	20		239
5850002	NR	09		184	6000001	NR	10		230	6010019	NR	20		239
5850020	NR	06		212	6000002	NR	10		230	6010020	NR	20		239
5850021	NR	06		212	6000003	NR	10		230	6010031	NR	22		237
5850023	NR	06		212	6000004	NR	10		230	6010033	NR	22		237
5850031	NR	09		142-184	6000100	NR	10		234	6100001	NR	02		224
5850040	NR	06		212	6000101	NR	10		234	6100002	NR	02		224
5850050	NR	06		214	6000102	NR	10		234	6100003	NR	02		224
5850051	NR	06		214	6000103	NR	10		234	6100004	NR	02		224
5850052	NR	06		214	6000104	NR	10		234	6100005	NR	02		224
5850060	NR	06		214	6000200	NR	10		231	6100006	NR	02		224
5850061	NR	06		214	6000201	NR	10		231	6100007	NR	02		224
5850082	NR	06		215	6000202	NR	10		231	6100008	NR	02		224
5850084	NR	06		215	6000203	NR	10		231	6100009	NR	02		224
5860001	NR	20		240	6000204	NR	10		231	6100010	NR	02		224
5860002	NR	20		240	6000210	NR	10		232	6100011	NR	02		224
5860003	NR	20		240	6000211	NR	10		232	6100012	NR	02		224
5860004	NR	20		240	6000212	NR	10		232	6100013	NR	02		224
5861002	NR	20		240	6000213	NR	10		232	6100014	NR	02		224
5861003	NR	20		240	6000214	NR	10		232	6100015	NR	02		224
5861004	NR	20		240	6000400	NR	10		233	6100016	NR	02		224
5861005	NR	20		240	6000401	NR	10		233	6100017	NR	02		224
5861006	NR	20		240	6000402	NR	10		233	6100018	NR	02		224
5862001	NR	20		240	6000403	NR	10		233	6100019	NR	02		224
5862002	NR	20		240	6000404	NR	10		233	6101001	NR	15		225
5862003	NR	20		240	6000600	NR	11		235	6101002	NR	15		225
5863001	NR	09		184	6000601	NR	11		235	6101003	NR	15		225
5863002	NR	09		184	6000602	NR	11		235	6101004	NR	15		225
5863101	NR	09		184	6000603	NR	11		235	6101005	NR	15		225
5863201	NR	09		184	6000604	NR	11		235	6101009	NR	15		225
5863301	NR	09		184	6000605	NR	11		235	6101010	NR	15		225
5863401	NR	09		184	6000606	NR	11		235	6101011	NR	15		225
5863501	NR	20		240	6000610	NR	11		236	6101012	NR	15		225
5901001	NR	03		241	6000611	NR	11		236	6101013	NR	15		225
5901002	NR	03		241	6000612	NR	11		236	6101015	NR	15		225
5901005	NR	03		241	6000613	NR	11		236	6101017	NR	15		225
5901011	NR	03		241	6000614	NR	11		236	6101018	NR	15		225
5901012	NR	03		241	6000615	NR	11		236	6101019	NR	15		225
5901013	NR	03		241	6000616	NR	11		236	6101020	NR	15		225

INDICE PER CODICE ARTICOLO

codice	UM	cat.	euro	pag.	codice	UM	cat.	euro	pag.	codice	UM	cat.	euro	pag.
6101021	NR	15		225	6170007	NR	11		220	6200007	NR	07		277
6101023	NR	15		225	6171001	NR	11		221	6200008	NR	07		277
6101025	NR	15		225	6171002	NR	11		221	6200010	NR	07		277
6101026	NR	15		225	6171003	NR	11		221	6200012	NR	07		277
6101027	NR	15		225	6171004	NR	11		221	6200014	NR	07		277
6101028	NR	15		225	6171005	NR	11		221	6200016	NR	07		277
6101029	NR	15		225	6171006	NR	11		220	6200018	NR	07		277
6101031	NR	15		225	6171007	NR	11		220	6201003	NR	07		277
6111001	NR	15		226	6172001	NR	11		220	6201004	NR	07		277
6111002	NR	15		226	6172002	NR	11		220	6201005	NR	07		277
6111003	NR	15		226	6172003	NR	11		220	6201007	NR	07		277
6111004	NR	15		226	6172004	NR	11		220	6201008	NR	07		277
6111005	NR	15		226	6172005	NR	11		220	6201010	NR	07		277
6111006	NR	15		226	6172006	NR	11		220	6201012	NR	07		277
6111007	NR	15		226	6190001	NR	09		227	6201014	NR	07		277
6111008	NR	15		226	6190002	NR	09		227	6201016	NR	07		277
6111009	NR	15		226	6190003	NR	09		227	6201018	NR	07		277
6111010	NR	15		226	6190004	NR	09		227	6202002	NR	07		277
6111011	NR	15		226	6190006	NR	09		227	6202003	NR	07		277
6111013	NR	15		226	6190009	NR	09		227	6202006	NR	07		277
6111014	NR	15		226	6190010	NR	09		227	6202007	NR	07		277
6111015	NR	15		226	6191001	NR	09		227	6202008	NR	07		277
6111016	NR	15		226	6191002	NR	09		227	6202009	NR	07		277
6111018	NR	15		226	6191003	NR	09		227	6203002	NR	07		277
6111019	NR	15		226	6191004	NR	09		227	6203003	NR	07		277
6111020	NR	15		226	6191009	NR	09		227	6203004	NR	07		277
6111021	NR	15		226	6191010	NR	09		227	6203006	NR	07		277
6111022	NR	15		226	6191011	NR	09		227	6203007	NR	07		277
6122001	NR	02		222	6191012	NR	09		227	6203009	NR	07		277
6122002	NR	02		222	6191101	NR	09		227	6203011	NR	07		277
6122003	NR	02		222	6191102	NR	09		227	6203013	NR	07		277
6122004	NR	02		222	6191201	NR	09		227	6203015	NR	07		277
6122011	NR	03		223	6191202	NR	09		227	6203017	NR	07		277
6122012	NR	03		223	6191402	NR	09		227	6204003	NR	07		277
6122013	NR	03		223	6191403	NR	09		227	6204004	NR	07		277
6122014	NR	03		223	6191404	NR	09		227	6204005	NR	07		277
6170001	NR	11		220	6191405	NR	09		227	6204007	NR	07		277
6170002	NR	11		220	6191406	NR	09		227	6204008	NR	07		277
6170003	NR	11		220	6191407	NR	09		227	6204010	NR	07		277
6170004	NR	11		220	6200003	NR	07		277	6204012	NR	07		277
6170005	NR	11		220	6200004	NR	07		277	6204014	NR	07		277
6170006	NR	11		220	6200005	NR	07		277	6204016	NR	07		277

INDICE PER CODICE ARTICOLO

codice	UM	cat.	euro	pag.	codice	UM	cat.	euro	pag.	codice	UM	cat.	euro	pag.
6204018	NR	07		277	6212050	NR	07		279	6222022	NR	07		279
6206002	NR	07		278	6212052	NR	07		279	6222024	NR	07		279
6206004	NR	07		278	6212053	NR	07		279	6222025	NR	07		279
6206005	NR	07		278	6212061	NR	07		279	6222032	NR	07		279
6206006	NR	07		278	6212065	NR	07		279	6222033	NR	07		279
6207002	NR	07		278	6212067	NR	07		279	6222041	NR	07		279
6207004	NR	07		278	6212068	NR	07		279	6222042	NR	07		279
6207005	NR	07		278	6212069	NR	07		279	6222050	NR	07		279
6207006	NR	07		278	6212074	NR	07		279	6224006	NR	07		279
6208003	NR	07		278	6212075	NR	07		279	6224007	NR	07		279
6208004	NR	07		278	6212077	NR	07		279	6224008	NR	07		279
6208005	NR	07		278	6212081	NR	07		279	6224014	NR	07		279
6208007	NR	07		278	6212088	NR	07		279	6224015	NR	07		279
6208008	NR	07		278	6212089	NR	07		279	6224017	NR	07		279
6208010	NR	07		278	6212091	NR	07		279	6224018	NR	07		279
6208012	NR	07		278	6212092	NR	07		279	6224020	NR	07		279
6208014	NR	07		278	6212098	NR	07		279	6224022	NR	07		279
6208016	NR	07		278	6212099	NR	07		279	6224023	NR	07		279
6208018	NR	07		278	6212100	NR	07		279	6224025	NR	07		279
6210003	NR	07		278	6212101	NR	07		279	6224026	NR	07		279
6210004	NR	07		278	6212104	NR	07		279	6224031	NR	07		279
6210005	NR	07		278	6212105	NR	07		279	6224032	NR	07		279
6210007	NR	07		278	6212107	NR	07		279	6224034	NR	07		279
6210008	NR	07		278	6212110	NR	07		279	6224035	NR	07		279
6210010	NR	07		278	6212111	NR	07		279	6224036	NR	07		279
6210012	NR	07		278	6212112	NR	07		279	6224041	NR	07		279
6210014	NR	07		278	6212113	NR	07		279	6224042	NR	07		279
6210016	NR	07		278	6212119	NR	07		279	6224046	NR	07		279
6210018	NR	07		278	6212123	NR	07		279	6224047	NR	07		279
6211003	NR	07		278	6212127	NR	07		279	6224048	NR	07		279
6211004	NR	07		278	6212128	NR	07		279	6224052	NR	07		279
6211005	NR	07		278	6212133	NR	07		279	6224053	NR	07		279
6211007	NR	07		278	6212143	NR	07		279	6224054	NR	07		279
6211008	NR	07		278	6212147	NR	07		279	6226002	NR	07		280
6211009	NR	07		278	6222006	NR	07		279	6226003	NR	07		280
6211012	NR	07		278	6222007	NR	07		279	6226004	NR	07		280
6211013	NR	07		278	6222013	NR	07		279	6226005	NR	07		280
6211014	NR	07		278	6222014	NR	07		279	6226007	NR	07		280
6211016	NR	07		278	6222016	NR	07		279	6226008	NR	07		280
6212025	NR	07		279	6222017	NR	07		279	6226010	NR	07		280
6212026	NR	07		279	6222018	NR	07		279	6226012	NR	07		280
6212048	NR	07		279	6222020	NR	07		279	6226014	NR	07		280

INDICE PER CODICE ARTICOLO

codice	UM	cat.	euro	pag.	codice	UM	cat.	euro	pag.	codice	UM	cat.	euro	pag.
6226016	NR	07		280	6406012	NR	02		281	6412016	NR	02		282
6226017	NR	07		280	6406013	NR	02		281	6412017	NR	02		282
6229003	NR	07		280	6407004	NR	02		281	6412018	NR	02		282
6229004	NR	07		280	6407006	NR	02		281	6412019	NR	02		282
6229005	NR	07		280	6407011	NR	02		281	6412020	NR	02		282
6229007	NR	07		280	6407014	NR	02		281	6412022	NR	02		282
6229008	NR	07		280	6407015	NR	02		281	6412023	NR	02		282
6229009	NR	07		280	6407017	NR	02		281	6412026	NR	02		282
6229010	NR	07		280	6407018	NR	02		281	6412027	NR	02		282
6229011	NR	07		280	6407019	NR	02		281	6412029	NR	02		282
6229012	NR	07		280	6407020	NR	02		281	6412030	NR	02		282
6229013	NR	07		280	6407021	NR	02		281	6412031	NR	02		282
6231003	NR	07		280	6410004	NR	02		281	6412032	NR	02		282
6231004	NR	07		280	6410005	NR	02		281	6417008	NR	02		282
6231005	NR	07		280	6410007	NR	02		281	6417009	NR	02		282
6231006	NR	07		280	6410008	NR	02		281	6419011	NR	02		282
6231007	NR	07		280	6410009	NR	02		281	6419014	NR	02		282
6231008	NR	07		280	6410010	NR	02		281	6419015	NR	02		282
6231009	NR	07		280	6410011	NR	02		281	6419016	NR	02		282
6231010	NR	07		280	6410016	NR	02		281	6419017	NR	02		282
6402005	NR	02		281	6410017	NR	02		281	6419018	NR	02		282
6402007	NR	02		281	6410018	NR	02		281	6420005	NR	02		282
6402013	NR	02		281	6410019	NR	02		281	6420010	NR	02		282
6402015	NR	02		281	6410020	NR	02		281	6420011	NR	02		282
6402016	NR	02		281	6410021	NR	02		281	6420012	NR	02		282
6402017	NR	02		281	6410022	NR	02		281	6420013	NR	02		282
6402018	NR	02		281	6410024	NR	02		281	6420014	NR	02		282
6402019	NR	02		281	6410025	NR	02		281	6420015	NR	02		282
6402020	NR	02		281	6410026	NR	02		281	6420016	NR	02		282
6402021	NR	02		281	6410027	NR	02		281	6420017	NR	02		282
6402022	NR	02		281	6410028	NR	02		281	6420018	NR	02		282
6402023	NR	02		281	6410030	NR	02		281	6430004	NR	02		282
6403006	NR	02		281	6410031	NR	02		281	6430006	NR	02		282
6403007	NR	02		281	6410033	NR	02		281	6430009	NR	02		282
6403008	NR	02		281	6410034	NR	02		281	6431002	NR	02		282
6403012	NR	02		281	6412004	NR	02		282	6431004	NR	02		282
6403014	NR	02		281	6412005	NR	02		282	6431009	NR	02		282
6403015	NR	02		281	6412006	NR	02		282	6431010	NR	02		282
6403016	NR	02		281	6412007	NR	02		282	6431011	NR	02		282
6403017	NR	02		281	6412008	NR	02		282	6500001	NR	07		271
6403020	NR	02		281	6412014	NR	02		282	6500003	NR	07		271
6403021	NR	02		281	6412015	NR	02		282	6500004	NR	07		271

INDICE PER CODICE ARTICOLO

codice	UM	cat.	euro	pag.	codice	UM	cat.	euro	pag.	codice	UM	cat.	euro	pag.
6500006	NR	07		271	6504017	NR	07		271	6552008	NR	10		258
6500009	NR	07		271	6504019	NR	07		271	6552010	NR	10		258
6500010	NR	07		271	6504020	NR	07		271	6552011	NR	10		258
6500014	NR	07		271	6504022	NR	07		271	6552012	NR	10		258
6500016	NR	07		271	6506003	NR	07		271	6552013	NR	10		258
6500020	NR	07		271	6506004	NR	07		271	6552014	NR	10		258
6502002	NR	07		271	6506005	NR	07		271	6553001	NR	10		259
6502003	NR	07		271	6506009	NR	07		271	6553002	NR	10		259
6502005	NR	07		271	6506010	NR	07		271	6553003	NR	10		259
6502006	NR	07		271	6506013	NR	07		271	6553004	NR	10		259
6502008	NR	07		271	6507001	NR	07		272	6554001	NR	10		258
6502009	NR	07		271	6507003	NR	07		272	6554003	NR	10		258
6502011	NR	07		271	6507009	NR	07		272	6554004	NR	10		258
6502012	NR	07		271	6507013	NR	07		272	6554005	NR	10		258
6502016	NR	07		271	6508002	NR	07		272	6554006	NR	10		258
6502017	NR	07		271	6508004	NR	07		272	6555001	NR	10		259
6502020	NR	07		271	6508008	NR	07		272	6555003	NR	10		259
6502022	NR	07		271	6508011	NR	07		272	6555004	NR	10		259
6502023	NR	07		271	6508013	NR	07		272	6555005	NR	10		259
6502027	NR	07		271	6509002	NR	07		272	6555006	NR	10		259
6503003	NR	07		271	6509003	NR	07		272	6555007	NR	10		259
6503004	NR	07		271	6509004	NR	07		272	6556001	NR	10		259
6503005	NR	07		271	6509006	NR	07		272	6556003	NR	10		259
6503008	NR	07		271	6509010	NR	07		272	6557001	NR	10		259
6503009	NR	07		271	6509011	NR	07		272	6557002	NR	10		259
6503010	NR	07		271	6509012	NR	07		272	6557003	NR	10		259
6503011	NR	07		271	6509013	NR	07		272	6557004	NR	10		259
6503012	NR	07		271	6509017	NR	07		272	6559001	NR	10		259
6503013	NR	07		271	6510001	NR	07		272	6559003	NR	10		259
6503014	NR	07		271	6510002	NR	07		272	6559004	NR	10		259
6503016	NR	07		271	6510003	NR	07		272	6601001	NR	01		273
6503017	NR	07		271	6511001	NR	07		272	6601002	NR	01		273
6504001	NR	07		271	6550001	NR	10		258	6601003	NR	01		273
6504003	NR	07		271	6550002	NR	10		258	6601004	NR	01		273
6504004	NR	07		271	6550003	NR	10		258	6601005	NR	01		273
6504005	NR	07		271	6550004	NR	10		258	6601006	NR	01		273
6504006	NR	07		271	6552001	NR	10		258	6601007	NR	01		273
6504008	NR	07		271	6552003	NR	10		258	6602001	NR	01		273
6504011	NR	07		271	6552004	NR	10		258	6602002	NR	01		273
6504012	NR	07		271	6552005	NR	10		258	6602003	NR	01		273
6504013	NR	07		271	6552006	NR	10		258	6602004	NR	01		273
6504014	NR	07		271	6552007	NR	10		258	6602005	NR	01		273

INDICE PER CODICE ARTICOLO

codice	UM	cat.	euro	pag.	codice	UM	cat.	euro	pag.	codice	UM	cat.	euro	pag.
6602006	NR	01		273	6606003	NR	01		274	6624005	NR	01		285
6602007	NR	01		273	6606004	NR	01		274	6624006	NR	01		285
6602009	NR	01		273	6606006	NR	01		274	6624007	NR	01		285
6602010	NR	01		273	6606009	NR	01		274	6624008	NR	01		285
6602011	NR	01		273	6606010	NR	01		274	6624009	NR	01		285
6602012	NR	01		273	6606011	NR	01		274	6626002	NR	01		285
6602015	NR	01		273	6606012	NR	01		274	6626004	NR	01		285
6602016	NR	01		273	6606014	NR	01		274	6626005	NR	01		285
6602017	NR	01		273	6606015	NR	01		274	6626006	NR	01		285
6602018	NR	01		273	6606017	NR	01		274	6626007	NR	01		285
6603001	NR	01		273	6607001	NR	01		274	6626008	NR	01		285
6603002	NR	01		273	6607002	NR	01		274	6626009	NR	01		285
6603003	NR	01		273	6607003	NR	01		274	6626010	NR	01		285
6603004	NR	01		273	6607004	NR	01		274	6626011	NR	01		285
6603005	NR	01		273	6608001	NR	01		274	6626012	NR	01		285
6603006	NR	01		273	6608002	NR	01		274	6626014	NR	01		285
6603007	NR	01		273	6608003	NR	01		274	6626015	NR	01		285
6603009	NR	01		273	6608004	NR	01		274	6626016	NR	01		285
6603010	NR	01		273	6608005	NR	01		274	6626017	NR	01		285
6603011	NR	01		273	6608006	NR	01		274	6626018	NR	01		285
6603012	NR	01		273	6609002	NR	01		274	6626020	NR	01		285
6603015	NR	01		273	6609004	NR	01		274	6628002	NR	01		286
6603016	NR	01		273	6609005	NR	01		274	6628004	NR	01		286
6603017	NR	01		273	6609006	NR	01		274	6628006	NR	01		286
6603018	NR	01		273	6609008	NR	01		274	6628007	NR	01		286
6604001	NR	01		273	6609011	NR	01		274	6628008	NR	01		286
6604002	NR	01		273	6620002	NR	01		285	6628009	NR	01		286
6604003	NR	01		273	6620004	NR	01		285	6628010	NR	01		286
6604004	NR	01		273	6620005	NR	01		285	6628011	NR	01		286
6604005	NR	01		273	6620007	NR	01		285	6628012	NR	01		286
6604006	NR	01		273	6620008	NR	01		285	6628013	NR	01		286
6605002	NR	01		274	6621002	NR	01		285	6628014	NR	01		286
6605003	NR	01		274	6621004	NR	01		285	6628015	NR	01		286
6605004	NR	01		274	6621006	NR	01		285	6628016	NR	01		286
6605006	NR	01		274	6621007	NR	01		285	6628017	NR	01		286
6605009	NR	01		274	6621008	NR	01		285	6628018	NR	01		286
6605010	NR	01		274	6621009	NR	01		285	6631001	NR	01		286
6605011	NR	01		274	6621011	NR	01		285	6631002	NR	01		286
6605012	NR	01		274	6621012	NR	01		285	6631003	NR	01		286
6605014	NR	01		274	6624001	NR	01		285	6631004	NR	01		286
6606001	NR	01		274	6624003	NR	01		285	6631005	NR	01		286
6606002	NR	01		274	6624004	NR	01		285	6631006	NR	01		286

INDICE PER CODICE ARTICOLO

codice	UM	cat.	euro	pag.	codice	UM	cat.	euro	pag.	codice	UM	cat.	euro	pag.
6631007	NR	01		286	6643005	NR	01		284	6645009	NR	01		284
6631008	NR	01		286	6643006	NR	01		283	6645010	NR	01		284
6631009	NR	01		286	6643009	NR	01		284	6645011	NR	01		284
6631010	NR	01		286	6643011	NR	01		284	6645012	NR	01		284
6636001	NR	01		286	6643013	NR	01		283	6645013	NR	01		284
6636002	NR	01		286	6643015	NR	01		284	6645014	NR	01		284
6636003	NR	01		286	6643018	NR	01		284	6645015	NR	01		284
6636004	NR	01		286	6643021	NR	01		284	6646001	NR	01		284
6637001	NR	01		283	6643024	NR	01		283	6646002	NR	01		284
6637002	NR	01		283	6643027	NR	01		284	6646003	NR	01		284
6637003	NR	01		283	6643029	NR	01		284	6646004	NR	01		284
6637004	NR	01		283	6643030	NR	01		284	6646005	NR	01		284
6637005	NR	01		283	6643031	NR	01		284	6646006	NR	01		284
6637006	NR	01		283	6643035	NR	01		283	6646007	NR	01		284
6637007	NR	01		283	6643037	NR	01		284	6646008	NR	01		284
6637008	NR	01		283	6643039	NR	01		284	6648001	NR	01		284
6638001	NR	01		283	6643041	NR	01		284	6648002	NR	01		284
6638002	NR	01		283	6643042	NR	01		283	6648003	NR	01		284
6638003	NR	01		283	6643043	NR	01		284	6648004	NR	01		284
6638004	NR	01		283	6643044	NR	01		284	6648005	NR	01		284
6638005	NR	01		283	6643046	NR	01		284	6648006	NR	01		284
6638006	NR	01		283	6643047	NR	01		283	6648007	NR	01		284
6638007	NR	01		283	6643048	NR	01		284	6648008	NR	01		284
6638008	NR	01		283	6643049	NR	01		284	6662001	NR	01		288
6639001	NR	01		283	6643050	NR	01		284	6662002	NR	01		288
6639002	NR	01		283	6643053	NR	01		283	6662003	NR	01		288
6639003	NR	01		283	6644001	NR	01		284	6662004	NR	01		288
6639004	NR	01		283	6644002	NR	01		284	6662005	NR	01		288
6639005	NR	01		283	6644003	NR	01		284	6663001	NR	01		288
6639006	NR	01		283	6644004	NR	01		284	6663003	NR	01		288
6639007	NR	01		283	6644005	NR	01		284	6663004	NR	01		288
6639008	NR	01		283	6644006	NR	01		284	6663005	NR	01		288
6640001	NR	01		283	6644007	NR	01		284	6663006	NR	01		288
6640002	NR	01		283	6644008	NR	01		284	6663008	NR	01		288
6640003	NR	01		283	6645001	NR	01		284	6664001	NR	01		288
6640004	NR	01		283	6645002	NR	01		284	6664002	NR	01		288
6640005	NR	01		283	6645003	NR	01		284	6664003	NR	01		288
6640006	NR	01		283	6645004	NR	01		284	6664004	NR	01		288
6640007	NR	01		283	6645005	NR	01		284	6664006	NR	01		288
6640008	NR	01		283	6645006	NR	01		284	6665001	NR	01		288
6643001	NR	01		283	6645007	NR	01		284	6665002	NR	01		288
6643004	NR	01		284	6645008	NR	01		284	6665003	NR	01		288

INDICE PER CODICE ARTICOLO

codice	UM	cat.	euro	pag.	codice	UM	cat.	euro	pag.	codice	UM	cat.	euro	pag.
6665004	NR	01		288	6673003	NR	01		287	6751006	NR	10		216-289
6665005	NR	01		288	6673005	NR	01		287	6751007	NR	10		216-289
6665006	NR	01		288	6673006	NR	01		287	6751008	NR	10		216-289
6665007	NR	01		288	6673007	NR	01		287	6751009	NR	10		216-289
6665008	NR	01		288	6673008	NR	01		287	6752001	NR	10		216-289
6665009	NR	01		288	6673009	NR	01		287	6752002	NR	10		216-289
6665011	NR	01		288	6673010	NR	01		287	6752003	NR	10		216-289
6665012	NR	01		288	6673011	NR	01		287	6752004	NR	10		216-289
6665013	NR	01		288	6673012	NR	01		287	6752005	NR	10		216-289
6666001	NR	01		288	6673013	NR	01		287	6752006	NR	10		216-289
6666003	NR	01		288	6673014	NR	01		287	6752007	NR	10		216-289
6666004	NR	01		288	6674001	NR	01		287	6752008	NR	10		216-289
6666005	NR	01		288	6674002	NR	01		287	6752009	NR	10		216-289
6666006	NR	01		288	6674003	NR	01		287	6753001	NR	10		217-290
6666007	NR	01		288	6674004	NR	01		287	6753002	NR	10		217-290
6666008	NR	01		288	6674005	NR	01		287	6753003	NR	10		217-290
6666009	NR	01		288	6674006	NR	01		287	6753004	NR	10		217-290
6668001	NR	01		288	6674007	NR	01		287	6753005	NR	10		217-290
6668002	NR	01		288	6674008	NR	01		287	6753006	NR	10		217-290
6668003	NR	01		288	6675001	NR	01		288	6753007	NR	10		217-290
6669001	NR	01		287	6675002	NR	01		288	6753008	NR	10		217-290
6669002	NR	01		287	6675003	NR	01		288	6753009	NR	10		217-290
6669003	NR	01		287	6675004	NR	01		288	6753010	NR	10		217-290
6669004	NR	01		287	6675005	NR	01		288	6753011	NR	10		217-290
6669005	NR	01		287	6676001	NR	01		288	6753012	NR	10		217-290
6670001	NR	01		287	6676002	NR	01		288	6753013	NR	10		217-290
6670002	NR	01		287	6676003	NR	01		288	6753014	NR	10		217-290
6670003	NR	01		287	6676004	NR	01		288	6753015	NR	10		217-290
6670004	NR	01		287	6676005	NR	01		288	6753016	NR	10		217-290
6670005	NR	01		287	6750001	NR	10		216-289	6753017	NR	10		217-290
6671001	NR	01		287	6750002	NR	10		216-289	6753018	NR	10		217-290
6671002	NR	01		287	6750003	NR	10		216-289	6753019	NR	10		217-290
6671003	NR	01		287	6750004	NR	10		216-289	6755001	NR	10		217-290
6671004	NR	01		287	6750005	NR	10		216-289	6755002	NR	10		217-290
6671005	NR	01		287	6750006	NR	10		216-289	6755003	NR	10		217-290
6672001	NR	01		287	6750007	NR	10		216-289	6755004	NR	10		217-290
6672002	NR	01		287	6750008	NR	10		216-289	6755005	NR	10		217-290
6672003	NR	01		287	6751001	NR	10		216-289	6755006	NR	10		217-290
6672004	NR	01		287	6751002	NR	10		216-289	6755007	NR	10		217-290
6672005	NR	01		287	6751003	NR	10		216-289	6755008	NR	10		217-290
6673001	NR	01		287	6751004	NR	10		216-289	6755009	NR	10		217-290
6673002	NR	01		287	6751005	NR	10		216-289	6755010	NR	10		217-290

INDICE PER CODICE ARTICOLO

codice	UM	cat.	euro	pag.	codice	UM	cat.	euro	pag.	codice	UM	cat.	euro	pag.
6755011	NR	10		217-290	6764006	NR	10		217-290	6802614	NR	11		236
6755012	NR	10		217-290	6764007	NR	10		217-290	6802615	NR	11		236
6755013	NR	10		217-290	6764008	NR	10		217-290	6802616	NR	11		236
6755014	NR	10		217-290	6764009	NR	10		217-290	6803000	NR	10		230
6755015	NR	10		217-290	6766001	NR	10		217-290	6803001	NR	10		230
6755016	NR	10		217-290	6766002	NR	10		217-290	6803002	NR	10		230
6756001	NR	10		216-289	6802000	NR	10		230	6803003	NR	10		230
6756002	NR	10		216-289	6802001	NR	10		230	6803004	NR	10		230
6756003	NR	10		216-289	6802002	NR	10		230	6803100	NR	10		234
6756004	NR	10		216-289	6802003	NR	10		230	6803101	NR	10		234
6756005	NR	10		216-289	6802004	NR	10		230	6803102	NR	10		234
6756006	NR	10		216-289	6802100	NR	10		234	6803103	NR	10		234
6756007	NR	10		216-289	6802101	NR	10		234	6803104	NR	10		234
6756008	NR	10		216-289	6802102	NR	10		234	6803200	NR	10		231
6756009	NR	10		216-289	6802103	NR	10		234	6803201	NR	10		231
6758001	NR	10		216-289	6802104	NR	10		234	6803202	NR	10		231
6758002	NR	10		216-289	6802200	NR	10		231	6803203	NR	10		231
6758003	NR	10		216-289	6802201	NR	10		231	6803204	NR	10		231
6758004	NR	10		216-289	6802202	NR	10		231	6803210	NR	10		232
6758005	NR	10		216-289	6802203	NR	10		231	6803211	NR	10		232
6758006	NR	10		216-289	6802204	NR	10		231	6803212	NR	10		232
6758007	NR	10		216-289	6802210	NR	10		232	6803213	NR	10		232
6758008	NR	10		216-289	6802211	NR	10		232	6803214	NR	10		232
6759001	NR	10		217-290	6802212	NR	10		232	6803400	NR	10		233
6759002	NR	10		217-290	6802213	NR	10		232	6803401	NR	10		233
6759003	NR	10		217-290	6802214	NR	10		232	6803402	NR	10		233
6759004	NR	10		217-290	6802400	NR	10		233	6803403	NR	10		233
6759005	NR	10		217-290	6802401	NR	10		233	6803404	NR	10		233
6763001	NR	10		217-290	6802402	NR	10		233	6803600	NR	11		235
6763002	NR	10		217-290	6802403	NR	10		233	6803601	NR	11		235
6763003	NR	10		217-290	6802404	NR	10		233	6803602	NR	11		235
6763004	NR	10		217-290	6802600	NR	11		235	6803603	NR	11		235
6763005	NR	10		217-290	6802601	NR	11		235	6803604	NR	11		235
6763006	NR	10		217-290	6802602	NR	11		235	6803605	NR	11		235
6763007	NR	10		217-290	6802603	NR	11		235	6803606	NR	11		235
6763008	NR	10		217-290	6802604	NR	11		235	6803610	NR	11		236
6763009	NR	10		217-290	6802605	NR	11		235	6803611	NR	11		236
6764001	NR	10		217-290	6802606	NR	11		235	6803612	NR	11		236
6764002	NR	10		217-290	6802610	NR	11		236	6803613	NR	11		236
6764003	NR	10		217-290	6802611	NR	11		236	6803614	NR	11		236
6764004	NR	10		217-290	6802612	NR	11		236	6803615	NR	11		236
6764005	NR	10		217-290	6802613	NR	11		236	6803616	NR	11		236

INDICE PER CODICE ARTICOLO

codice	UM	cat.	euro	pag.	codice	UM	cat.	euro	pag.	codice	UM	cat.	euro	pag.
6804000	NR	10		230	6805003	NR	10		230	6806101	NR	10		234
6804001	NR	10		230	6805004	NR	10		230	6806102	NR	10		234
6804002	NR	10		230	6805100	NR	10		234	6806103	NR	10		234
6804003	NR	10		230	6805101	NR	10		234	6806104	NR	10		234
6804004	NR	10		230	6805102	NR	10		234	6806200	NR	10		231
6804100	NR	10		234	6805103	NR	10		234	6806201	NR	10		231
6804101	NR	10		234	6805104	NR	10		234	6806202	NR	10		231
6804102	NR	10		234	6805200	NR	10		231	6806203	NR	10		231
6804103	NR	10		234	6805201	NR	10		231	6806204	NR	10		231
6804104	NR	10		234	6805202	NR	10		231	6806210	NR	10		232
6804200	NR	10		231	6805203	NR	10		231	6806211	NR	10		232
6804201	NR	10		231	6805204	NR	10		231	6806212	NR	10		232
6804202	NR	10		231	6805210	NR	10		232	6806213	NR	10		232
6804203	NR	10		231	6805211	NR	10		232	6806214	NR	10		232
6804204	NR	10		231	6805212	NR	10		232	6806400	NR	10		233
6804210	NR	10		232	6805213	NR	10		232	6806401	NR	10		233
6804211	NR	10		232	6805214	NR	10		232	6806402	NR	10		233
6804212	NR	10		232	6805400	NR	10		233	6806403	NR	10		233
6804213	NR	10		232	6805401	NR	10		233	6806404	NR	10		233
6804214	NR	10		232	6805402	NR	10		233	6806600	NR	11		235
6804400	NR	10		233	6805403	NR	10		233	6806601	NR	11		235
6804401	NR	10		233	6805404	NR	10		233	6806602	NR	11		235
6804402	NR	10		233	6805600	NR	11		235	6806603	NR	11		235
6804403	NR	10		233	6805601	NR	11		235	6806604	NR	11		235
6804404	NR	10		233	6805602	NR	11		235	6806605	NR	11		235
6804600	NR	11		235	6805603	NR	11		235	6806606	NR	11		235
6804601	NR	11		235	6805604	NR	11		235	6806610	NR	11		236
6804602	NR	11		235	6805605	NR	11		235	6806611	NR	11		236
6804603	NR	11		235	6805606	NR	11		235	6806612	NR	11		236
6804604	NR	11		235	6805610	NR	11		236	6806613	NR	11		236
6804605	NR	11		235	6805611	NR	11		236	6806614	NR	11		236
6804606	NR	11		235	6805612	NR	11		236	6806615	NR	11		236
6804610	NR	11		236	6805613	NR	11		236	6806616	NR	11		236
6804611	NR	11		236	6805614	NR	11		236	6807000	NR	10		230
6804612	NR	11		236	6805615	NR	11		236	6807001	NR	10		230
6804613	NR	11		236	6805616	NR	11		236	6807002	NR	10		230
6804614	NR	11		236	6806000	NR	10		230	6807003	NR	10		230
6804615	NR	11		236	6806001	NR	10		230	6807004	NR	10		230
6804616	NR	11		236	6806002	NR	10		230	6807100	NR	10		234
6805000	NR	10		230	6806003	NR	10		230	6807101	NR	10		234
6805001	NR	10		230	6806004	NR	10		230	6807102	NR	10		234
6805002	NR	10		230	6806100	NR	10		234	6807103	NR	10		234

INDICE PER CODICE ARTICOLO

codice	UM	cat.	euro	pag.	codice	UM	cat.	euro	pag.	codice	UM	cat.	euro	pag.
6807104	NR	10		234	6808202	NR	10		231	6809210	NR	10		232
6807200	NR	10		231	6808203	NR	10		231	6809211	NR	10		232
6807201	NR	10		231	6808204	NR	10		231	6809212	NR	10		232
6807202	NR	10		231	6808210	NR	10		232	6809213	NR	10		232
6807203	NR	10		231	6808211	NR	10		232	6809214	NR	10		232
6807204	NR	10		231	6808212	NR	10		232	6809400	NR	10		233
6807210	NR	10		232	6808213	NR	10		232	6809401	NR	10		233
6807211	NR	10		232	6808214	NR	10		232	6809402	NR	10		233
6807212	NR	10		232	6808400	NR	10		233	6809403	NR	10		233
6807213	NR	10		232	6808401	NR	10		233	6809404	NR	10		233
6807214	NR	10		232	6808402	NR	10		233	6810000	NR	10		230
6807400	NR	10		233	6808403	NR	10		233	6810001	NR	10		230
6807401	NR	10		233	6808404	NR	10		233	6810002	NR	10		230
6807402	NR	10		233	6808600	NR	11		235	6810003	NR	10		230
6807403	NR	10		233	6808601	NR	11		235	6810004	NR	10		230
6807404	NR	10		233	6808602	NR	11		235	6810100	NR	10		234
6807600	NR	11		235	6808603	NR	11		235	6810101	NR	10		234
6807601	NR	11		235	6808604	NR	11		235	6810102	NR	10		234
6807602	NR	11		235	6808605	NR	11		235	6810103	NR	10		234
6807603	NR	11		235	6808606	NR	11		235	6810104	NR	10		234
6807604	NR	11		235	6808610	NR	11		236	6810200	NR	10		231
6807605	NR	11		235	6808611	NR	11		236	6810201	NR	10		231
6807606	NR	11		235	6808612	NR	11		236	6810202	NR	10		231
6807610	NR	11		236	6808613	NR	11		236	6810203	NR	10		231
6807611	NR	11		236	6808614	NR	11		236	6810204	NR	10		231
6807612	NR	11		236	6808615	NR	11		236	6810210	NR	10		232
6807613	NR	11		236	6808616	NR	11		236	6810211	NR	10		232
6807614	NR	11		236	6809000	NR	10		230	6810212	NR	10		232
6807615	NR	11		236	6809001	NR	10		230	6810213	NR	10		232
6807616	NR	11		236	6809002	NR	10		230	6810214	NR	10		232
6808000	NR	10		230	6809003	NR	10		230	6810400	NR	10		233
6808001	NR	10		230	6809004	NR	10		230	6810401	NR	10		233
6808002	NR	10		230	6809100	NR	10		234	6810402	NR	10		233
6808003	NR	10		230	6809101	NR	10		234	6810403	NR	10		233
6808004	NR	10		230	6809102	NR	10		234	6810404	NR	10		233
6808100	NR	10		234	6809103	NR	10		234	6811000	NR	10		230
6808101	NR	10		234	6809104	NR	10		234	6811001	NR	10		230
6808102	NR	10		234	6809200	NR	10		231	6811002	NR	10		230
6808103	NR	10		234	6809201	NR	10		231	6811003	NR	10		230
6808104	NR	10		234	6809202	NR	10		231	6811004	NR	10		230
6808200	NR	10		231	6809203	NR	10		231	6811100	NR	10		234
6808201	NR	10		231	6809204	NR	10		231	6811101	NR	10		234

INDICE PER CODICE ARTICOLO

codice	UM	cat.	euro	pag.	codice	UM	cat.	euro	pag.	codice	UM	cat.	euro	pag.
6811102	NR	10		234	6812404	NR	10		233	6906080	NR	10		228
6811103	NR	10		234	6813002	NR	10		230	6906090	NR	10		229
6811104	NR	10		234	6813003	NR	10		230	6906100	NR	10		229
6811200	NR	10		231	6813004	NR	10		230	6906120	NR	10		229
6811201	NR	10		231	6813102	NR	10		234	6906140	NR	10		229
6811202	NR	10		231	6813103	NR	10		234	6906160	NR	10		229
6811203	NR	10		231	6813104	NR	10		234	6906180	NR	10		229
6811204	NR	10		231	6813202	NR	10		231	6906200	NR	10		229
6811210	NR	10		232	6813203	NR	10		231	6908035	NR	10		228
6811211	NR	10		232	6813204	NR	10		231	6908050	NR	10		228
6811212	NR	10		232	6813212	NR	10		232	6908060	NR	10		228
6811213	NR	10		232	6813213	NR	10		232	6908070	NR	10		228
6811214	NR	10		232	6813214	NR	10		232	6908080	NR	10		228
6811400	NR	10		233	6813402	NR	10		233	6908090	NR	10		229
6811401	NR	10		233	6813403	NR	10		233	6908100	NR	10		229
6811402	NR	10		233	6813404	NR	10		233	6908120	NR	10		229
6811403	NR	10		233	6814002	NR	10		230	6908140	NR	10		229
6811404	NR	10		233	6814003	NR	10		230	6908160	NR	10		229
6812000	NR	10		230	6814004	NR	10		230	6908180	NR	10		229
6812001	NR	10		230	6814102	NR	10		234	6908200	NR	10		229
6812002	NR	10		230	6814103	NR	10		234	6910035	NR	10		228
6812003	NR	10		230	6814104	NR	10		234	6910050	NR	10		228
6812004	NR	10		230	6814202	NR	10		231	6910060	NR	10		228
6812100	NR	10		234	6814203	NR	10		231	6910070	NR	10		228
6812101	NR	10		234	6814204	NR	10		231	6910080	NR	10		228
6812102	NR	10		234	6814212	NR	10		232	6910090	NR	10		229
6812103	NR	10		234	6814213	NR	10		232	6910100	NR	10		229
6812104	NR	10		234	6814214	NR	10		232	6910120	NR	10		229
6812200	NR	10		231	6814402	NR	10		233	6910140	NR	10		229
6812201	NR	10		231	6814403	NR	10		233	6910160	NR	10		229
6812202	NR	10		231	6814404	NR	10		233	6910180	NR	10		229
6812203	NR	10		231	6850001	MT	06		308	6910200	NR	10		229
6812204	NR	10		231	6850002	MT	06		308	6912035	NR	10		228
6812210	NR	10		232	6904120	NR	10		229	6912050	NR	10		228
6812211	NR	10		232	6904140	NR	10		229	6912060	NR	10		228
6812212	NR	10		232	6904160	NR	10		229	6912070	NR	10		228
6812213	NR	10		232	6904180	NR	10		229	6912080	NR	10		228
6812214	NR	10		232	6904200	NR	10		229	6912090	NR	10		229
6812400	NR	10		233	6906035	NR	10		228	6912100	NR	10		229
6812401	NR	10		233	6906050	NR	10		228	6914035	NR	10		228
6812402	NR	10		233	6906060	NR	10		228	6914050	NR	10		228
6812403	NR	10		233	6906070	NR	10		228	6914060	NR	10		228

INDICE PER CODICE ARTICOLO

codice	UM	cat.	euro	pag.	codice	UM	cat.	euro	pag.	codice	UM	cat.	euro	pag.
6914070	NR	10		228	9090480	MT	18		304	9190760	MT	18		305
6914080	NR	10		228	9090540	MT	18		304	9190890	MT	18		305
6914090	NR	10		229	9090600	MT	18		304	9191140	MT	18		305
6914100	NR	10		229	9090760	MT	18		304	9191250	MT	18		305
800102101075	MQ	18		305	9090890	MT	18		304	9209010	MT	07		302
800132101075	MQ	18		305	9091140	MT	18		304	9209015	MT	07		302
800192101075	MQ	18		305	9130120	MT	18		304	9209020	MT	07		302
800252101075	MQ	18		305	9130150	MT	18		304	9209025	MT	07		302
800322101075	MQ	18		305	9130180	MT	18		304	9209050	MT	07		302
850VR020444	NR	02		303	9130220	MT	18		304	9209100	MT	07		302
850VR0204501	NR	02		303	9130250	MT	18		304	9209150	MT	07		302
850VR0204511	NR	02		303	9130280	MT	18		304	9250220	MT	18		305
850VR0204521	NR	02		303	9130350	MT	18		304	9250280	MT	18		305
850VR0204531	NR	02		303	9130420	MT	18		304	9250350	MT	18		305
850VR0204541	NR	02		303	9130480	MT	18		304	9250420	MT	18		305
850VR0204551	NR	02		303	9130540	MT	18		304	9250480	MT	18		305
850VR0204561	NR	02		303	9130600	MT	18		304	9250540	MT	18		305
850VR0204571	NR	02		303	9130640	MT	18		304	9250600	MT	18		305
850VR0204581	NR	02		303	9130760	MT	18		304	9250760	MT	18		305
850VR0204651	NR	02		303	9130890	MT	18		304	9250890	MT	18		305
850VR0204661	NR	02		303	9131140	MT	18		304	9251140	MT	18		305
850VR0204671	NR	02		303	9131250	MT	18		304	9259025	MT	07		302
850VR020471	NR	02		303	9169010	MT	07		302	9259050	MT	07		302
9060120	MT	18		304	9169015	MT	07		302	9259100	MT	07		302
9060150	MT	18		304	9169020	MT	07		302	9310002	MT	09		306
9060180	MT	18		304	9169025	MT	07		302	9310004	MT	09		306
9060200	MT	18		304	9169050	MT	07		302	9310005	MT	09		306
9060220	MT	18		304	9169100	MT	07		302	9310006	MT	09		306
9060250	MT	18		304	9169150	MT	07		302	9310007	MT	09		306
9060280	MT	18		304	9190150	MT	18		304	9310008	MT	09		306
9060350	MT	18		304	9190180	MT	18		304	9310009	MT	09		306
9060420	MT	18		304	9190200	MT	18		304	9320280	MT	18		305
9090100	MT	18		304	9190220	MT	18		304	9320350	MT	18		305
9090120	MT	18		304	9190250	MT	18		304	9320420	MT	18		305
9090150	MT	18		304	9190280	MT	18		304	9320480	MT	18		305
9090180	MT	18		304	9190320	MT	18		304	9320540	MT	18		305
9090200	MT	18		304	9190350	MT	18		304	9320600	MT	18		305
9090220	MT	18		304	9190420	MT	18		304	9320640	MT	18		305
9090250	MT	18		304	9190480	MT	18		304	9320760	MT	18		305
9090280	MT	18		304	9190540	MT	18		305	9320890	MT	18		305
9090350	MT	18		304	9190600	MT	18		305	9321140	MT	18		305
9090420	MT	18		304	9190640	MT	18		305	9400420	MT	18		305

INDICE PER CODICE ARTICOLO

codice	UM	cat.	euro	pag.	codice	UM	cat.	euro	pag.	codice	UM	cat.	euro	pag.
9400480	MT	18		305										
9400540	MT	18		305										
9500890	MT	18		305										
9601140	MT	18		305										
9950600	MT	18		305										
9950760	MT	18		305										
PN0200220	MT	09		309										
PN0200270	MT	09		309										
PN0200340	MT	09		309										
PN0200420	MT	09		309										
PN0250480	MT	09		309										
PN0250600	MT	09		309										
PN0300760	MT	09		309										
PN0300880	MT	09		309										
PN0401140	MT	09		309										
PNC200220	NR	09		309										
PNC200270	NR	09		309										
PNC200340	NR	09		309										
PNC200420	NR	09		309										
PNC250480	NR	09		309										
PNC250600	NR	09		309										
PNC300760	NR	09		309										
PNC300880	NR	09		309										
PNC401140	NR	09		309										

ASSOCIATI GRUPPO DELFINO - ANNO 2021



www.deloitalia.com



ASSOCIATI GRUPPO DELFINO - ANNO 2021



www.deloitalia.com



NOTE

I dati, le misure, gli articoli, i prezzi, le caratteristiche tecniche e tutti gli altri dati riportati nel nostro listino hanno carattere indicativo. Possono essere variati senza nessun preavviso. Hanno valore vincolante unicamente in caso di espressa indicazione nell'accettazione dell'ordine o nella conferma d'ordine. I prezzi sono IVA esclusa.

delfino
DOVE SIAMO



Associato di zona:

Delò
Delfino Società Cooperativa
Via del lavoro, 25/A - 40051
Altedo - Bologna - Italy
Tel. 051-6601281 - Fax 051-9711140
info@deloitalia.com

www.deloitalia.com - www.delfino.it

Il Gruppo Delfino, proprietario del brand **Delò®**, è anche **Corporate Golden Donor del FAI - Fondo Ambiente Italiano.**

